



ACCORD GROUP



2022

SINCE 1933

buffet | tabletop | bar

























Ihr Mehrwert: Inspiration & Service

- ✓ aktuellste Nonfood-Trends im Sortiment
- ✓ hohe Warenverfügbarkeit

Your added value: Inspiration & Service

- ✓ latest nonfood-trends in the range
- ✓ high availability of goods

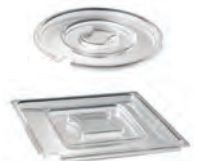

p. 20 	p. 73 	p. 136 
p. 163 	p. 195 	p. 254 
p. 267 	p. 276 	p. 325 
p. 358 	p. 364 	p. 371 
p. 378 	p. 396 	p. 399 
p. 419 	p. 426 	p. 436 
p. 486 	p. 504 	p. 511 
p. 525 	p. 531 	p. 533 

Buffet & Display

Buffet & Tableware
Melamin

Tableware &
Table Presentation

Baskets

Chafing Dish,
GN Container & Transport

Bar, Café & Drinkware

Kitchen & Servings tools

Covers & Accessories

APS – KNOW-HOW

We only work with the raw material manufacturer who has the best technology in the industry.



MELAMINE

- ✓ 100% pure melamine
- ✓ BPA free, urea free
- ✓ perfect for serving dishes
- ✓ extremely break and shock resistant
- ✓ sustainable due to durability and robustness
- ✓ hygienic surfaces
- ✓ environmentally friendly due to low processing temperature
- ✓ 100% dishwasher safe
- ✓ useable up to max. 70°C

STAINLESS STEEL

Chrome-nickel steel is used in a wide variety of products due to its attractive appearance, as a brightly polished, ground or brushed variant.

- ✓ hygienic surface
- ✓ durable and easy to clean
- ✓ recyclable
- ✓ good temperature conductor
- ✓ 100% dishwasher safe

PLASTIC PP - PS - SAN

- ✓ crystal clear
- ✓ hygienic surface
- ✓ easy to clean
- ✓ recyclable
- ✓ BPA free
- ✓ high resistance to heat
- ✓ durable, no disposable plastic



WOOD acacia-beech-oak



PORCELAIN



Präzisionsarbeit und Design für Ihren Erfolg

Precision work and design for your success



state-of-the-art
manufacturing
technology



eco-friendly



high
professional
usability

QUALITÄT

- ✓ Jedes Produkt muss mehr als zwei Qualitätskontrollen bestehen
- ✓ Wir verwenden nur 100% reines Material
- ✓ Jedes Rohmaterial wird streng geprüft

QUALITY

- ✓ each product must pass more than two quality checks
- ✓ we only use 100% pure material
- ✓ each raw material is strictly tested

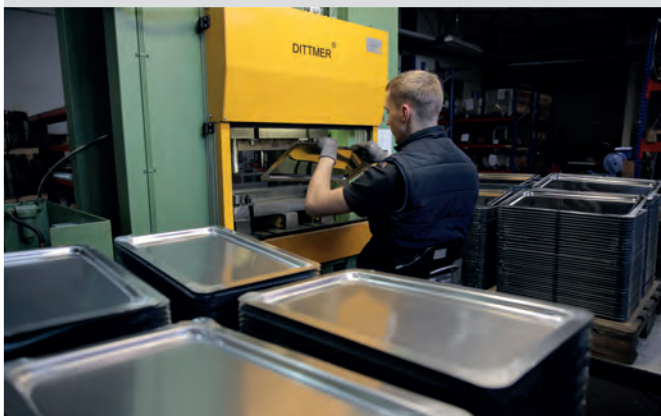

APS production | Made in Germany (tray no. 11100)

DESIGN

- ✓ Unsere eigenständig entwickelten Produkte verfügen über zahlreiche Design-Patente im In- und Ausland
- ✓ Wir entwickeln Produktlösungen für jeden individuellen Kundenbedarf

DESIGN

- ✓ our independently developed products have rich / multi design patents at home and abroad
- ✓ we develop product solutions for every individual customer need



Design team

DEUTSCH

Artikel	Seite
A	
Abräumwagen	408-409
Abtropfmatte	451
Adapter / Zwischensteg	401
Allzweckgießer	302, 458
Antirutschmatte	170
Aschenbecher	471-475
Aufstrichmesser	501
Ausgießer	455
Ausstellblech	509
Austernmesser	498
B	
Backblech	404
Backform	509
Backhandschuhe	510
Baguette Korb	357, 364
Bain-Marie	392
Bar-Caddy	452
Barlöffel	442
Barmaß	439-441
Barmatte	451
Barsieb	443, 445
Becher	268, 426-434
Becher Emaille	320
Behälter	409
Bento Box	174
Beschriftungsetiketten	74, 348
Beschriftungskarten	342
Besteckablage	256, 395
Besteckbehälter	21, 105, 150-154, 187, 335-339, 410-411
Besteckkorb	334, 364-365
Besteckständer	105-106, 152-154, 334-337, 339
Besteckständer Melamin	105
Bestecktaschen	318
Beton	40, 76, 157, 193-194, 294, 307, 312-313, 341, 424, 474
Bierglasträger	425
Blattschale Melamin	201, 217, 244
Bonleiste	514
Bonspieß	514
Brennpastenbehälter Edelstahl	394
Brezel- oder Wurstständer	86, 141
Brötchenschütte	210, 251, 355
Brötchenspender Edelstahl	102
Brotkorb	355, 365-366, 369
Brottschneidebrett	23, 94-95, 142
Brotstation	94
Brottasche	367-369, 373
Buffet Kühlset	14, 18, 27, 30-33, 35-38
Buffet Kühlset Edelstahl	28-29, 33-34
Buffet-Set	35, 113, 121
Buffetbrett	132, 140, 141
Buffetbrücke	72
Buffetgestell	72-74, 79-82, 85-92, 100, 102, 106, 326, 364
Buffetkorb	16, 176, 356, 358, 361-363
Buffetleiter	79-80, 83
Buffetschilder	341, 345, 347
Buffetständer	66, 71-73, 76-77, 79-83, 85, 89-91, 100, 106-109, 115, 176, 205, 253, 374-375
Buffetständer Edelstahl	176
Buffetständer Holz	71-73, 76-77, 86-88, 109
Buffetständer Metall	73, 79-83, 85, 89-90, 109, 115, 206
Buffetvitrine	26-29, 36-37, 97
Buffetvitrine Edelstahl	28-29
Bürste Bar	449
Butter- und Saucenwärmer	305
Butterdose	304
Butterservierer	304
C	
Caddy	93, 136, 153-154, 306-309, 334, 452
Cerealienspender	21, 64-67
Cerealienspender Edelstahl	65-66
Chafing Dish	378-379, 381-386, 388-390
Chafing Dish Rolltop	385-386, 389
Champagnerkühler	420-421
Cocktailmesser	445, 497
D	
Dariorform	509
Deckel	19, 34, 160-161, 171, 237, 241-242, 249, 532-534
Deckel Edelstahl	325, 400-401
Dekoriermesser	445, 498
Desinfektionsspender	98
Desinfektionsständer	98
Dip-Schälchen	223, 248, 250
Dispenser Milch	20, 39-46, 49-52
Dispenser Saft	20, 39-46, 49-51, 53
Dispenser Saft / Milch	20, 39-46, 49
Dosier- & Vorratsflasche	454
Dosierer Zucker	301-303, 458-460
Dosierpumpe	518
Dosierspender	518
Dressingtopf Edelstahl	74
Dressingtopf Melamin	74-75
Dressingtopf Porzellan	75
E	
Eier-Box	511
Eierbecher	256, 304
Eierkorb	363
Eierschneider	502
Eimer	413, 511
Eis-Kugel-Former	448
Eisbox	16, 447
Eiseimer	416, 446
Eisportionierer	492, 515
Eisschaufel	448
Eiswaffel-Ständer	515
Eiswasseröhre	40
Eiswürfelform	456
Eiszange	449
Eiszerkleinerer	448
Emaille-Artikel	319-320
Entkerner	497
Etagère	73, 87-89, 91-92, 131, 233
F	
Fadenschneider	496
Fast-Food Tablett	145, 469
Feuerzangenbowle-Set	305, 349, 391, 435-436
Fingerfood-Löffel	257-258
Flambierbrenner	463, 502
Flasche	58, 60, 536
Flaschenhalter Wein	425
Flaschenkühler	21, 62, 416-417, 419-425, 429, 453
Flaschenöffner	62, 457
Flaschenträger	425
Fleisch- / Gemüseplatte	110
Folien-Abreibvorrichtung	514
Fondue-Set	305, 349, 391, 436
Frischhaltedeckel	19, 34, 327
G	
Gabel Fleisch	480-481, 485
Gabel Salat	484
Gebäckpalette	499
Gebäckzange	486, 490-492
Gemüsehobel	506
Getränkspender	39-47, 452
Getränkewanne	61, 419, 420
Gewürzkasten	518
Gewürzmühle	285-290
Gewürzständer	293-300
Gewürzstreuer	291-292
Gläsernschiene	418, 433
Glasplatte	121
Glasmrander	448
Glocke	332
GN Abtropfgitter	401-402
GN Behälter	24, 111, 396, 398-399, 402-403, 405-407
GN Behälter Edelstahl	111, 398-399
GN Besteckbehälter	151, 359, 404, 410
GN Buffet-Set	113, 405, 407
GN Buffetgestell	364
GN Buffetleiter	83-84
GN Buffetständer	206
GN Buffetvitrine Edelstahl	28
GN Chafing Dish	378, 381-382, 385-386, 389-390
GN Deckel	400-403, 406
GN Haube	113, 191, 363, 524-526
GN Konvektomatenblech	404
GN Korb	16, 352, 354, 359-361, 363
GN Korb Metall	371-372
GN Korb Polypropylen	352, 354, 359-361
GN Naturschieferplatte	24-25, 128-129
GN Partyplatte	123
GN Rost	404
GN Schale Melamin	163, 166, 168, 209
GN Servierbrett	132
GN Serviergestell	17, 85
GN Tablett	15, 25, 71, 110-113, 127, 144-145, 234, 405
GN Tablett Edelstahl	110-113, 234
GN Tablett Melamin	25, 71, 163-166, 170, 178, 180, 183-184, 186, 188, 191, 194-195, 197-198, 206, 211-212, 215, 220, 227, 231, 237-239, 243
GN Tablett Porzellan	127, 405
GN Wanne	15, 24
Gourmetgläser	322
Gourmetlöffel	268
H	
Haube	16-17, 103, 117-119, 121, 149, 204, 253, 527-531
Haube Rolltop	16-17, 117, 120, 253, 392, 526-527
Haube Rolltop Edelstahl	392
Haubenhalterung	103
Heizelement	53, 385-386, 392-394
Hobel	141, 498, 506
Holzbox	22-25, 94, 136, 139, 153-154, 283, 306-309, 334
Honiglöffel	495
Humberbrecher	502
Hygieneschutz	96, 99, 102
I	
Induktionskochplatte	78, 379-380, 387, 393
Iso-Dispenser	46
Isolierkanne	54-55
K	
Kaffeebecher	256
Kaffeedispenser Edelstahl	53, 392
Kaffeekanne	461
Kanne	59-60
Kanne Saft	59-60
Karaffe Glas	56-57, 59
Kartenhalter	340-346
Käseglocken-Set	120
Käsehobel	498
Kaviarkühler	118, 305
Kellnermesser	457
Kerzenleuchter	310-312
Konditorplatte	146-147, 185, 213, 252, 329
Konferenzkühler	21, 62, 453
Korb Edelstahl	373
Korb Metall	369, 371-375
Korb Polypropylen	353, 356-358, 361-363, 366
Korkenzieher	457
Kreide-Marker	348
Kronkorkenschale	62
Kugelausstecher	496
Kühlakku	19, 62, 535
Kühlbox	18, 30, 31, 61, 447
Kühlkaraffe	58
Kühlmanschette	425
Kühlschale	19, 32-34
Kühltablett	14, 27, 29
L	
Likör- und Fondanttrichter	506
Limettenpresse	446, 513
Löffel	479-480, 485, 492-495
Löffel Backen	492
Löffel Feinkost	268, 493, 495
Löffel Fingerfood	228
Löffel Frittieren	505
Löffel Gourmet	268
Löffel Salat	255, 483, 484
Löffel Saucen/Dressing	480, 483, 485, 493
Löffel Spaghetti	480, 482
Lunchbag	373
Lunchbox	537
M	
Magnet-Messerhalter	514
Mandoline	506
Menage	242, 293-300
Messbecher	507-508
Messlöffelsatz	492
Metallrahmen für Induktionskochplatte	382-384, 393
Milchdispenser	20, 39-46, 49-52
Milchgießer/-kännchen	460-461
Milchkanne	51-52, 460-461
Minis	248, 259-262
Moscow Mule Becher	429-431
Mühle Pfeffer	285-290
Mühle Salz	285-290
Multi Rack Edelstahl	104-105
Multibox	93
Muscheltopf	327
Müslispender	21, 64-67
N	
Naturschieferplatte	24-25, 128-131, 277-278, 290
P	
Palmbattschale Melamin	244-245
Panierstation	513
Parmesan Menage	298
Partyplatte	123
Passiersieb	503-504
Pastateller Melamin	243
Pendelschäler	497
Permanent-Ausgießer	455
Pfanne	115, 270, 272
Pfannenwender	478, 483-484
Pfeffermühle	285-290
Pinsel	513
Pinzettzange	449, 489
Pitcher	60
Pizzaform	519, 521
Pizzaschaufel	502, 510
Pizzaschneider	497, 502, 521
Platzsets	314-317
Platzteller	332
Pommes-Frites-Seiher	505
Porzellan	379, 384
Pump-Isolierkanne	54
Q	
Quetschflasche	515-517
R	
Rechnungstablett	333, 470

Regalwagen	409
Reinigungsbürste	449
Rezeptionsglocke	466
Rolltop-Set	120-121, 130
Rührbecher	508
Rührglas	454
S	
Saftdispenser	39-45, 49-51, 53
Saftkanne	59-60
Salat-Löffel	255
Salatbesteck	494
Salatzange	479, 486-487, 490
Salzmühle	285-290
Sauciere	331
Schälchenspender	81
Schale Aluminium	274, 370
Schale Beton	76
Schale Edelstahl	19, 114, 266-267, 273, 373-374
Schale Emaille	304, 319-320
Schale Glas	79-81, 534
Schale Holz	138-139, 275-276
Schale Melamin	19, 34, 81, 160, 162-163, 165, 167-169, 171, 177, 179, 181-182, 185, 187-188, 190, 192-194, 197, 199, 201, 204, 207-210, 213, 217-219, 221-227, 229-237, 240-248, 250, 253, 255, 259-262, 346
Schaufel	495, 511
Schaufel Eis	448
Schaufel Mehl	510
Schaumlöffel	479, 482
Schaumspesering	507
Schiefer	24-25, 86, 91, 121, 128-131, 133-134, 146, 212, 214, 251, 277-279, 281, 290, 468
Schilder	342-343, 345
Schlüsselschnur	453
Schneebesens	503
Schneidbrettständer	515
Schneidbrett	15, 23, 94-95, 100, 445
Schöpflöffel	479-480, 482
Sektkühler	61, 416-417, 419, 421-422
Senftöpfchen	295
Service Tower	106
Servier-/Tortenplatte Edelstahl	329-330
Servier-/Tortenplatte Holz	135, 147-148, 328, 330
Servier-/Tortenplatte Melamin	146, 252, 329-330
Servier-Frittierkorb	271
Servierbox	254, 269, 283-284
Servierbrett	132-137, 139-141, 276, 279-281, 468
Serviergabel	480-481, 485
Serviergestell	82, 85, 89-92, 326
Servierkelle	269, 464
Servierkorb	274, 358, 370
Servierlöffel	255, 479-485
Servierpfanne	115, 270, 272
Servierpfanne Gusseisen	270
Servierset	160-161, 209
Serviertablett	119, 124-125, 143-144, 464-470
Serviertöpfchen	118, 268, 272-273
Servierwagen	408-409
Servierzange	486
Serviettenhalter	155-157
Serviettenringe	333
Serviettentaschen	318
Shaker	437-438
Sieb	443, 445, 503-504
Snackbox	254, 269, 283-284, 537
Snackholder	271-276
Snackpresenter	101
Sortierbox	93
Spachtel	501
Spaghettizange	479, 486, 488
Spargelzange	486
Sparschäler	496
Speisenwärmer	394
Spießständer / Spieße	305
Spitzsieb	505-506
Spritzflasche	300, 454
Standascher	475
Ständer Wein- / Sektkühler	418
Staubkappen	453
Stielkasserolle	268
Stößel	444
Stövchen	63
Streichpalette	499
Streuer Pfeffer	291-292
Streuer Salz	291-292, 505
Superbox	22-25
Suppenkelle	483
Suppentopf	383, 389-390
Sushiboard Melamin	184, 225-226
T	
Table Caddy	153-154, 306-309, 334
Tablett	15, 94, 112-119, 124, 126, 143, 145, 267, 280, 282, 355, 468-469
Tablett Edelstahl	15, 112-119, 124, 126, 267, 282, 464-466
Tablett Fast Food	136, 145, 469
Tablett Holz	103, 121-122, 145, 280, 468-469
Tablett Melamin	25, 71, 163-164, 166, 170, 178-180, 183-186, 188, 191, 193-199, 205-208, 211-217, 219-221, 225-228, 231, 235, 237-239, 253, 262, 290
Tasse Melamin	256
Teebox	93
Teebrühsieb	463
Teekanne ASIA	63, 461
Teigbehälter	412, 521
Teigschaber / Abstecher	501
Teller Emaille	319
Teller Fingerfood	234
Teller Melamin	144, 162, 164, 172, 177, 179, 181-182, 184, 186, 189, 196, 200, 218, 221, 240, 246-247, 253-256, 261
Thekendisplay	97, 101
Thermo Tablett-Set	36-38
Thermo-Set	31
Tischaufsteller	347
Tischkartenhalter	342-346
Tischkrümelentferner	332, 470
Tischrestebehälter	335-336, 338
Tischsets	314-318
Tortenheber	483, 485
Tortennmesser	483
Tortenplatte	120, 130, 146-148, 185, 213, 252
Tortenring	509
Transportwagen	408-409
Trenner	356
Tretbeutlhalter	475
Trichter	413, 512
Trinkbecher	42-45, 268, 426-428
Trinkflasche	536
Trinkglas	41
Trinkhalme	450
Tropfenschale Melamin	40
U	
Universalbox	17, 70
Universalkanne	460-461, 507
Untersetzer Edelstahl	333
Untersetzer Kork	42-44, 520
Untersetzer Naturschiefer	130-131, 277, 290
V	
Vase	313
Verschluss Wein / Champagner	455

Vorratsglas	68-70
Vorspeisenzange	488
W	
Wachspapier	132, 136, 282, 284
Wanne	412
Warenträger	123, 314
Wärme-Kies	395
Warnschild	521, 535
Wasserbadschüssel	506
Wasserkanne	59
Wasserspender	39-47, 452
Weck Gläser	70, 82, 321-326
Weinkühler	61, 416-417, 419, 421-422
Weinkühlerständer	418
Wender	478, 482-484, 499-500
Windaschenbecher	471-474
Windlicht	312
Z	
Zange	449, 479, 486-488, 490-491
Ziseliermesser	496
Zitronenschnitzelpresse	463
Zitruspresse	445-446, 513
Zuckerdosierer	301-303, 458-460
Zuckerkugel	303, 463
Zuckerspender	301-303, 458-460
Zuckertüten-Box Edelstahl	462
Zutatenbehälter	452



ENGLISH

item	page
A	
adapter	401
air pot	54
airtight cover	19, 34, 327
appetizer tong	488
ashtray	471-475
asparagus tongs	486
B	
baguette basket	357, 364
bain marie bailing bowl	506
Bain-Marie	392
baking mittens	510
baking pan	509
baking sheet	404
bar caddy	452
bar knife	445, 497
bar spoon	442
bar strainer	443, 445
barrel mug	268, 426-434
basket metal	369, 371-375
basket PP	353, 356-358, 361-363, 366
basket stainless steel	373
beaker	320
beer rack	425
Bento Box	174
beverage dispenser	39-47, 452
beverage tub	61, 419-420
bill presenter	333, 470
bill rail	514
bill spike	514
bottle	58, 60, 536
bottle cooler	21, 62, 416-417, 419-425, 429, 453
bottle fuel	394
bottle opener	62, 457
bottle rack	425
bowl aluminium	274, 370
bowl concrete	76
bowl enamel	304, 319-320
bowl glass	79-81, 534
bowl holder	81
bowl melamine	19, 34, 81, 160, 162-163, 165, 167-169, 171, 177, 179, 181-182, 185, 187-188, 190, 192-194, 197, 199, 201, 204, 207-210, 213, 217-219, 221-227, 229-237, 240-248, 250, 253, 255, 259-262

bowl stainless steel	19, 114, 266-267, 273, 373-374
bowl wood	138-139, 275-276
bread basket	367-369, 373
bread station	94
Breadbox	355, 365-366, 369
breeding set	513
brush	513
bucket	413, 511
buffet basket	16, 176, 356, 358, 361-363
buffet bridge	72
buffet ladder	79, 80, 83
buffet set	35, 113, 121
buffet signs	341, 345, 347
buffet stand	66, 71-74, 76-77, 79-83, 85-92, 100, 102, 106-109, 115, 176, 205, 253, 326, 364, 374-375
buffet stand metal	73, 79-83, 85, 89-90, 109, 115, 206
buffet stand stainless steel	176
buffet stand wood	71-73, 76-77, 86-88, 109
Buffet-board	132, 140-141
butter and sauce pan warmer	305
butter dish	304
C	
caddy	93, 136, 153-154, 306-309, 334, 452
cake lifter	483, 485
cake plate melamine	146, 252, 329-330
cake plate stainless steel	329-330
cake plate wood	135, 147-148, 328, 330
cake setting ring	509
cake slice	483
cake stand	120, 130, 146-148, 185, 213, 252, 329
candle holder	310-312
canele / decorating knife	496
canister	68-70
cap bowl	62
cast iron pan	270
caviar cooler	118, 305
cereal dispenser	21, 64-67
cereal dispenser stainless steel	65-66
Chafing Dish	378-379, 381-382, 384-386, 388-390
Chafing Dish Rolltop	385-386, 389
chalk marker	348
champagne bowl	61, 416-417, 419-422
champagne / wine saver	455
cheese dish	298
cheese slicer	498
chefs blow torch	463, 502
chopping board	15, 23, 94-95, 100, 445
citrus squeezer	445-446, 513
cleaning brush	449
clingfilm tear-off dispenser	514
cloche / dome cover	332
coaster cork	42-44, 520
coaster natural slate	130-131, 277, 290
coaster stainless steel	333
coffee cup	256
coffee dispenser stainless steel	53, 392
coffee pot	461
concrete	40, 76, 157, 193-194, 294, 307, 312-313, 341, 424, 474
condiment container	518
condiment holder	452
confectionery funnel	506
conference bottle cooler	21, 62, 453
conical strainer	505-506
cool collar	425
cooler	19, 62, 535
cooling bowl	19, 32-34
cooling box	18, 30-31, 61, 447
cooling box stainless steel	28-29, 33-34

cooling carafe	58	GN buffet display stainless steel	28	mixing glass	454	serving trowel	269, 464
cooling plates	14, 27, 29	GN buffet ladder	83, 84	Moscow Mule barrel mug	429-431	set measuring spoon	492
corer	497	GN buffet set	113, 405, 407	mousse ring	507	shaker	291-292, 437-438
corkscrew	457	GN buffet stand	206, 364	muddler	444	shape sorter	93
cornet stand	515	GN Chafing Dish	378, 381-382, 385-386, 389-390	multi rack stainless steel	104-105	showcase	26-29, 36-37, 97, 101
cover	16-17, 19, 34, 103, 117-119, 121, 149, 160-161, 171, 204, 237, 241-242, 249, 253, 527-534	GN cover	113, 191, 363, 524-526	multibox	93	showcase stainless steel	28-29
cover holder	103	GN cutlery organizer	151, 359, 404, 410	mussel pot	327	skewer rack/skewer	305
cover stainless steel	325, 400-401	GN grid	404	mustard glass	295	skimmer spoon	479, 482, 492
crumber	332, 470	GN natural slate tray	24-25, 128-129	N		slate	24-25, 86, 91, 121, 128-131, 133-134, 146, 212, 214, 251, 277-279, 281, 290, 468
cup melamine	256	GN pan stainless steel	111, 398-399	napkin bag	318	small serving pot	118, 268, 272-273
curler	141, 498, 506	GN partytray	123	napkin holder	155-157	snack tray	136, 145, 469
cutlery bag	318	GN serving board	132	napkin rings	333	snackbox	254, 269, 283-284, 537
cutlery basket	105-106, 152-154, 334-337, 339	GN serving stand	17, 85	natural slate tray	24-25, 128-131, 277-278, 290	snackpresenter	101
cutlery basket melamine	105	GN tray	15, 24-25, 71, 110-113, 127, 144-145, 234, 405	non slip mat	170	oyster knife	463
cutlery dispenser	334, 364-365	GN tray melamine	25, 71, 163-164, 166, 170, 178, 180, 183-184, 186, 188, 191, 194-195, 197-198, 206, 211-212, 215, 220, 227, 231, 237-239, 243	oyster knife	498	soup ladle	483
cutlery organizer	21, 105, 150-154, 187, 335-337, 339, 410-411	GN tray porcelain	127, 405	P		soup pot	383, 389-390
cutlery rest	256, 395	GN tray stainless steel	110-113, 234	palm leaf melamine	244-245	soup pot	383, 389-390
cutting board	23, 94-95, 142	GN-container	24, 111, 396, 398-399, 402-403, 405-407	pan	115, 270, 272	spaghetti spoon	480, 482
cutting board rack	515	GN-convection oven trays	404	party spoon	228, 257-258, 268	spaghetti tong	479, 486, 488
D		GN-drainer	401-402	partytray	123	spatula	499
Dariol moulds	509	GN-lid	400-403, 406	pasta plate melamine	243	spice mill	285-290
decorating knife	445, 498	gourmet glasses	322	pastry spatula	499	spice rack	293-300
decorator / zester	496	graduated jug	507-508	pastry tongs	486, 490-492	spice shaker	291-292
delicatessen spoon	268, 493, 495	granite chips	395	pedal bin	475	spider spoon	505
designation cards	342	gravy boat	331	peeler	496	spoon	479-480, 485, 493-495
desinfectant dispenser	98	greaseproof paper squares	132, 136, 282, 284	pepper mill	285-292	squeeze bottle	300, 454, 515-517
desinfection stand	98	H		pitcher	59-60	stainless steel frame for induction plate	382-384, 393
dip bowl	223, 248, 250	heating unit	53, 385-386, 392-394	pizza cutter	497, 502, 521	stand for wine / champagne bowl	418
dispenser	518	honey spoon	495	pizza dish	519, 521	standing ashtray	475
dispenser sugar	301-303, 458-460	hygienic cover	96, 99, 102	pizza peel	502, 510	stirring cup	508
display	123, 314	I		placemat	314-318	strainer	443, 445, 503-504
display tray	509	ice ball former	448	plate enamel	319	straws	450
divider	356	ice box	16, 447	plate melamine	144, 162, 164, 172, 177, 179, 181-186, 189, 196, 200, 218, 221, 240, 246-247, 253, 255-256, 261	sugar dispenser	301-303, 458-460
dosing pump	518	ice bucket	416, 446	plate tray	332	sugar pocket holder	462
dough container	412, 521	ice cream scoop	492, 515	plate warmer	394	sugar pot	303, 463
dough scraper	501	ice crusher	448	porcelain	379, 384	superbox	22-25
dressing pot melamine	74-75	ice cube cooling tube	40	pourers	302, 455, 458	sushiboard melamine	184, 225-226
dressing pot porcelain	75	ice cube maker	456	pouring container	454	swivel peeler	497
dressing pot stainless steel	74	ice scoop	448	pretzel-/ sausage stand	86, 141	T	
dressing/sauce spoon	480, 483, 485, 493	ice tong	449	R		table caddy	153-154, 306-309, 334
drinking bottle	536	induction plate	78, 379-380, 387, 393	refrigerated buffet display	14, 18, 27, 30-33, 35-38	table garbage bin	335-336, 338
drinking cups	41-45, 268, 426-428	insulated dispenser	46	ring bell	466	table stands	340-347
drip mat	451	J		roll / bun basket	210, 251, 355	tea-box	93
drip tray melamine	40	jigger	439-441	roll dispenser stainless	102	teapot ASIA	63, 461
dust & fly cap	453	jug	461, 507	rolltop cover	16, 17, 117, 120, 253, 392, 526-527	teapot warmer	63
E		juice and milk dispenser	20, 39-46, 49	rolltop set	120-121, 130	thermo set	31
egg basket	363	juice dispenser	20, 39-46, 49-51, 53	rolltop set cheese	120	thermo tray	36-38
egg cutter	502	juice pitcher	59-60	rolltop-cover stainless steel	392	tong	449, 479, 486-488, 490-491
egg holder	256, 304	K		S		tray	15, 73, 87-89, 91-92, 94, 110, 112-119, 124-125, 131, 143-146, 233, 267, 280, 282, 355, 464-470
eggs box	511	key cord	453	salad fork	484	tray melamine	25, 71, 163-164, 166, 170, 178-180, 183-186, 188, 191, 193-199, 205-208, 211-217, 219-221, 225-228, 231, 235, 237-239, 253, 262, 290
enamel articles	319-320	L		salad spoon	255, 483-484	tray stainless steel	15, 112-119, 124, 126, 267, 282, 464-466
F		labeling labels	74, 348	salad spoon + fork	494	tray wood	103, 121-122, 145, 280, 468-469
fingerfood plate	234	labels	342-343, 345	salad tong	479, 486-487, 490	trolley	409
fire punch bowl set	305, 349, 391, 435-436	ladle	479-480, 482	salt mill	285-292, 505	turner	478, 482-484, 499-500
flower vase	313	leaf melamine	201, 217, 244	sandwich knife	501	tweezer	449, 489
fondue set	305, 349, 391, 436	lemon slice squeezer	463	sauté pan / mini sauce pan	268	U	
fork	480-481, 485	lime press	446, 513	scoop	495, 511	universal box	17, 70
free flow pourer	455	lobster cracker	502	scoop flour	510	V	
fry baskets	271	lunch bag	373	scraper	501	vacuum jug	54-55
fry dripping tray	505	lunchbox	537	service tower	106	W	
funnel	413, 512	M		service trolley	408-409	waiter's corkscrew	457
G		magnetic knife rack	514	serving basket	274, 358, 370	warning sign	521, 535
glass carafe	56-57, 59	mandolin	506	serving board	132-137, 139-141, 276, 279-281, 468	water pitcher	59
glass plate	121	meatfork	480-481, 485	serving box	254, 269, 283-284	Weck-bottles	70, 82, 321-326
glass rack	418, 433	melon baller	496	serving cup	271-276	whisk	503
glass rimmer	448	menage	242, 293-300	serving set	160-161, 209	wind lights / candle holder	312
GN basket	16, 352, 354, 359-361, 363	milk dispenser	20, 39-46, 49-52, 460-461	serving spoon	255, 479-485		
GN basket metal	371-372	milk jug	460-461	serving stand	82, 85, 89-92, 326		
GN basket polypropylene	352, 354, 359-361	mini bowl	248, 259-262	serving tongs	486		
GN bowl melamine	163, 166, 168, 209			serving trolley	408-409		

wine bowl 61, 416-417, 419, 421-422
 winebottle-stand 425
 woodbox 22-25, 94, 136, 139, 153-154,
 283, 306-309, 334

ESPAÑOL

artículos pág.

A	
abre ostras	498
abridor	62, 457
acumulador de frío	19, 62, 535
adaptador	401
aro anti-goteo melamina	40
aro de tarta	509
aro redondo para semifríos	507
artículos esmaltados	319-320
azucarero	301-303, 458-460
B	
bajo plato	332
bandeja	15, 94, 112-119, 124-126, 143-144, 267, 280, 282, 355, 464-470
bandeja acero inoxidable	15, 112-119, 124, 126, 267, 282, 464-466
bandeja autoservicio y snacks	136, 145, 469
bandeja con alturas	73, 87-89, 91-92, 131, 233
bandeja de pizarra natural	24-25, 128-131, 277-278, 290
bandeja de vidrio	121
bandeja isotérmica	31
bandeja madera	103, 121-122, 145, 280, 468-469
bandeja melamina	25, 71, 163, 164, 166, 170, 178-180, 183-186, 188, 191, 193-199, 205-208, 211-217, 219-221, 225-228, 231, 235, 237-239, 253, 262, 290
bandeja para sushi melamina	184, 225-226
bandeja party	123
bandeja pastelera	404, 509
bandeja tartas acero inoxidable	329-330
bandeja tartas madera	135, 147-148, 328, 330
bandeja tartas melamina	146, 252, 329-330
bandeja termo	36-38
bandejas refrigeradas	14, 27
baño María	392
barra magnética para cuchillos	514
barreño botellines	61, 419-420
batidor	503
Bento Box	174
bol refrigerado	19, 32-34
bolsa cubiertos	318
bolsa de almuerzo	373
bolsa de servilletas	318
bomba dosificadora	518
bote	68-70
bote de mostaza	295
bote dosificador flexible	515-517
bote vertedor universal	302, 458
botella	58, 60, 536
botella „store & pour“	454
botella de combustible líquido	394
botella exprimible	300, 454
botes especieros	291-292
brocha	513
C	
caballetes buffet	341, 345, 347
caballetes de mesa	347
cacerola	115, 270, 272
caddy	93, 136, 153-154, 306-309, 334
caddy de mesa	153-154, 306-309, 334
cafetera	461

caja comida	254, 269, 283-284
caja de pan para buffet	355, 365-366, 369
caja dispensadora	17, 70
caja madera	22-25, 94, 136, 139, 153-154, 283, 306-309, 334
caja para huevos	511
caja para sobres de azúcar	462
caja para té	93
caja surtida	93
calentador de mantequilla y salsa	305
calentador de tetera	63
calienta platos	394
campana	16-17, 103, 117-119, 121, 149, 204, 253, 527-531
campana esférica	332
campana rolltop	16-17, 117, 120, 253, 392, 526-527
campana rolltop acero inoxidable	392
candelabro	310-312
cantimplora	536
carro	409
carro de servicio	408-409
cazo para baño maría	506
cazo recto bajo	268
cenicero	471-475
cenicero de pie	475
cepillo de limpieza	449
cesta acero inoxidable	373
cesta de baguette	357, 364
cesta de buffet	16, 176, 356, 358, 361-363
cesta de huevos	363
cesta metal	369, 371-375
cesta para bollos	210, 251, 355
cesta para servir	274, 358, 370
cesta polipropileno	353, 356-358, 361-363, 366
cestitas para el servicio mesa	271
Chafing Dish	378-379, 381, 382, 384-386, 388-390
Chafing Dish Rolltop	385-386, 389
champañera	420-421
coctelera	437-438
colador	443, 445, 503-504
colador cónico	505-506
colador de cóctel	443, 445
conjunto aperitivo	242, 293-300
corta huevos	502
corta pasta	501
cortador de pizza	497, 502, 521
cupeta	412
cubierta higiénica antialiento	96, 99, 102
cubitera	16, 447
cubitera isotérmica	416, 446
cubitera para cava	61, 416-417, 419, 421-422
cuco	413, 511
cuchara	479-480, 485, 493-495
cuchara de espaguetis	480, 482
cuchara de miel	495
cuchara gourmet	268, 493, 495
cuchara para ensalada	255, 483, 484
cuchara para helado	492, 515
cuchara para hornear	492
cuchara para servir	255, 479-485
cuchara party	257, 258
cucharilla de cóctel	442
cucharón	479, 480, 482
cucharón de salsa/aliño	480, 483, 485, 493
cucharón de sopa	483
cuchillo acanalador	445, 498
cuchillo de decoración cincelador	496
cuchillo para cóctel	445, 497
cuchillo para untar	501
cuenco acero inoxidable	19, 114, 266-267, 273, 373-374

cuenco aluminio	274, 370
cuenco de vidrio	79-81, 534
cuenco esmaltado	304, 319-320
cuenco hormigón	76
cuenco madera	138-139, 275-276
cuenco melamina	19, 34, 81, 160, 162-163, 165, 167-169, 171, 177, 179, 181-182, 185, 187-188, 190, 192-194, 197, 199, 201, 204, 207-210, 213, 217-219, 221-227, 229-237, 240-248, 250, 253, 255, 259-262
cuenco mini	248, 259-262
cuenco para chapas	62
cuenco para dip	223, 248, 250
D	
descorazonador	497
dispensador buffet en escalera	79-80, 83
dispensador de bebidas	39-47, 452
dispensador de bocadillos	101
dispensador de café acero inoxidable	53, 392
dispensador de cereales	21, 64-67
dispensador de cereales acero inoxidable	65-66
dispensador de desinfectante	98
dispensador de film	514
dispensador de leche	20, 39-46, 49-52, 460-461
dispensador de panecillos acero inoxidable	102
dispensador de salsa	518
dispensador de zumo	20, 39-46, 49-51, 53
dispensador en escalera acero inoxidable	104-105
dispensador isotérmico	46
dispensador mixto zumo y leche	20, 39-46, 49
divisor	356
E	
embudo	413, 512
embudo dosificador	506
enfriador de botellas	21, 62, 416-417, 419-425, 429, 453
enfriador de caviar	118, 305
enfriador múltiple	21, 62, 453
escurridor de fritos	505
espatula	478, 482-484, 499-500
espátula plancha	501
especiero	293-300, 518
espumadera	479, 482
espumadera para fritos	505
estación de desinfección	98
estación de empanado	513
estación pan	94
esterilla antideslizante	170
esterilla escurridora	451
etiquetas	74, 342-343, 345, 348
expositor	123, 314
expositor buffet frío	18, 29, 30-31, 61, 447
expositor buffet frío acero inoxidable	28-29, 33-34
expositor de buffet	66, 71-74, 76-77, 79-83, 85-92, 100, 102, 106-109, 115, 176, 205, 253, 326, 364, 374-375
expositor de buffet acero inoxidable	176
expositor de buffet madera	71-73, 76-77, 86-88, 109
expositor de buffet metal	73, 79-83, 85, 89-90, 109, 115, 206
exprimidor cítricos	445-446, 513
F	
fiambarrera	537
flaneras	509
florero	313
fuelle de servicio	110
fuelle en forma de hoja de palmera	
melamina	244-245

fuelle en forma de hoja melamina	201, 217, 244
fuelle para la mesa	115, 270, 272
funda de frío	425
G	
GN bandeja	15, 25, 71, 110-113, 127, 144-145, 234, 405
GN bandeja acero inoxidable	110-113, 234
GN bandeja de pizarra natural	24-25, 128-129
GN bandeja melamina	25, 71, 163-164, 166, 170, 178, 180, 183-184, 186, 188, 191, 194-195, 197-198, 206, 211-212, 215, 220, 227, 231, 237-239, 243
GN bandeja party	123
GN bandeja porcelana	127, 405
GN campana	113, 191, 363, 524-526
GN cesta	16, 352, 354, 359-361, 363
GN cesta metal	371-372
GN cesta polipropileno	352, 354, 359-361
GN Chafing Dish	378, 381-382, 385-386, 389-390
GN cubeta	15, 24, 111, 396, 398-399, 402-403, 405-407
GN cubeta acero inoxidable	111, 398-399
GN cubeta para hornos de convección	404
GN cuenco melamina	163, 166, 168, 209
GN dispensador buffet en escalera	83-84
GN escurridor	401-402
GN expositor buffet acero inoxidable	28
GN porta cubiertos	151, 359, 404, 410
GN rejilla	404
GN set buffet	113, 405, 407
GN soporte para buffet	17, 85, 206, 364
GN tabla de servir	132
GN tapa	400-403, 406
granulado térmico	395
H	
hormigón	40, 76, 157, 193-194, 294, 307, 312-313, 341, 424, 474
huevo	256, 304
I	
infusor de té, pinza con malla	463
J	
jarra	59-60, 460-461, 507
jarra de agua	59
jarra de leche	460-461
jarra de vidrio	56-57, 59
jarra de zumo	59-60
jarra enfriadora	58
jarra graduada	507-508
jarra termo	54-55
juego de cucharas medidoras	492
L	
llavero enrollable	453
M	
mandolina	506
manoplas de panadero	510
mantelín	314-318
mantequillera	304
marco de acero inoxidable para placa de inducción	382-384, 393
marco pastelero	509
marmita	383, 389-390
medidor jigger	439-441
mejillonera	327
molde de cubitos de hielo esféricos	448
molde de pizza	519, 521
molde para cubitos de hielo	456
molinillo de pimienta	285-292
molinillo de sal	285-292, 505
molino de especias	285-290
mortero	444
Moscow Mule taza	429-431
multibox	93

O	
olla pequeña de servir	118, 268, 272-273
organizador de bar	452
P	
pajas	450
pala	495, 511
pala de hielo	448
pala de pizza	502, 510
pala de tartas	483, 485
pala para harina	510
paleta para servir	269, 464
paleta pastelera	499
panera	367-369, 373
papel alimenticio	132, 136, 282, 284
papelera de sobremesa	335-336, 338
pelador reversible	496-497
picadora de hielo	448
pie porta champañera / vino	418
pinchanotas	514
pinza	449, 479, 486-488, 490-491
pinza bogavante	502
pinza de emplatador	449, 489
pinza ensalada	479, 486-487, 490
pinza espaguetis	479, 486, 488
pinza exprime limón	463
pinza para aperitivos	488
pinza para cubitos de hielo	449
pinza para espárragos	486
pinza para pasteles	486, 490-492
pinza universal	486
pizarra	24-25, 86, 91, 121, 128-131, 133-134, 146, 212, 214, 251, 277-279, 281, 290, 468
placa de inducción	78, 379-380, 387, 393
plato esmaltado	319
plato melamina	144, 162, 164, 172, 177, 179, 181-182, 184, 186, 189, 196, 200, 218, 221, 240, 246-247, 253, 255-256, 261
plato para el aperitivo	234
plato para pasta melamina	243
polvoreador	291-292
porcelana	379, 384
porcionador de pastel	483
porta botellas	425
porta cubiertos	21, 105-106, 150-154, 187, 334-337, 339, 364-365, 410-411
porta cubiertos melamina	105
porta cuenta	333, 470
porta menú	340-346
porta vasos de cerveza	425
porta-tarjetas	342-346
portafichas	514
portavelas antiviento	312
posavasos acero inoxidable	333
posavasos corcho	520
posavasos pizarra natural	131, 290
prensa de limón	446, 513
punteo de buffet	72
Q	
quesera parmesano	298
R	
rack de copas	418, 433
rack dispensador de cuencos	81
rebanador de queso	498
recipiente de ingredientes	452
recipiente organizador	409
recipiente para masa	412, 521
recoemigas	332, 470
reposa cuchara	256, 395
resistencia	53, 385-386, 392-394
ribeteador de vasos	448
rizador	141, 498, 506
rotulador de tiza	348
S	
sacacorchos	457

salsera	331
salsera acero inoxidable	74
salsera melamina	74-75
salsera porcelana	75
sartén de hierro fundido	270
señal de advertencia	521, 535
service tower	106
servidor de ensalada	494
servilletero	155-157
servilleteros/aros	333
set de buffet	35, 113, 121
set de buffet refrigerado	14, 18, 27, 30-33, 35-38
set para fondue	305, 349, 391, 436
set para ponche caliente	305, 349, 391, 435-436
set para servir	160-161, 209
set rolltop	120-121, 130
set rolltop para queso	120
snackbox	254, 269, 283, 284, 537
soplete de cocina para flambeo	463, 502
soprote a pedal	475
soprote campana	103
soprote cucuruchos	515
soprote de pretzels o salchichas	86, 141
soprote para botella de vino	425
soprote para brochetas	30
soprote para paste	120, 130, 146-148, 185, 213, 252, 329
soprote para tablas de cortar	515
soprote platos	82, 85, 89-92, 326
superbox	22-25
T	
tabla de corte	23, 94-95, 142
tabla de servir	132-137, 139-141, 276, 279-281, 468
tabla para cortar	15, 23, 94-95, 100, 445
tabla para el buffet	132, 140-141
tapa	19, 34, 160-161, 171, 237, 241-242, 249, 532-534
tapa acero inoxidable	325, 400-401
tapa hermética	19, 34, 327
tapete escurridor	451
tapón antipolvo	453
tapón vertedor	455
tarjetas	342
tarros gourmet	322
taza	268, 426-434
taza de café	256
taza melamina	256
tenedor de carne	480-481, 485
tenedor de ensalada	484
tenedor de servicio	480-481, 485
tetera ASIA	63, 461
timbre	466
tubo enfriador para cubitos	40
V	
vaciador de melón redondo	496
vaso agitador	508
vaso coctelero	320
vaso mezclador vertedor	454
vaso para servir	271-276
vasos	41-45, 268, 426-428
vertedor continuo	455
vertedores	455
vitrina de buffet	26-29, 36-37, 97
vitrina de buffet acero inoxidable	28-29
vitrina de mostrador	97, 101
W	
Weck-botellas	70, 82, 321-326

FRANÇAIS

item	pág.
A	
accumulateur de froid	19, 62, 535
adaptateur	401
anneau coupe-gouttes mélamine	40
anneaux à serviettes	333
ardoise	24-25, 86, 91, 121, 128-131, 133-134, 146, 212, 214, 251, 277-279, 281, 290, 468
articles en email	319-320
assiette creuse mélamine	243
assiette de présentation	332
assiette email	319
assiette mélamine	144, 162, 164, 172, 177, 179, 181-182, 184, 186, 189, 196, 200, 218, 221, 240, 246-247, 253, 255-256, 261
assiette pour apéritif	234
B	
bac	412
Bain-Marie	392
barre aimantée pour couteaux	514
barre porte-bons	514
base bois	22-25, 94, 136, 139, 153-154, 283, 306-309, 334
bassine à glace	61, 419-420
Bento Box	174
béton	40, 76, 157, 193-194, 294, 307, 312-313, 341, 424, 474
beurrier	304
boîte à épices	518
boîte à ingrédients	452
boîte à lunch	537
boîte à œufs	511
boîte à pain pour le buffet	355, 365-366, 369
boîte à thés et infusions	93
boîte de tri	93
boîte distributrice	17, 70
boîte-repas	254, 269, 283-284
bol acier inox	19, 114, 266-267, 273, 373-374
bol aluminium	274, 370
bol béton	76
bol bois	138-139, 275-276
bol email	304, 319-320
bol en verre	79-81, 534
bol mélamine	19, 34, 81, 160, 162-163, 165, 167-169, 171, 177, 179, 181-182, 185, 187-188, 190, 192-194, 197, 199, 201, 204, 207-210, 213, 217-219, 221-227, 229-237, 240-248, 250, 253, 255, 259-262
bol mélangeur	320
bol mini	248, 259-262
bol récupérateur de capsules	62
bol réfrigéré	19, 32-34
bordeur à verres	448
bouchon anti-poussières et anti-insectes	453
bouchon verseur	455
boule à thé avec pince	463
bouteille	58, 60, 536
bouteille „store & pour“	454
bouteille de combustible liquide	394
bouteille isotherme	54-55
bouteille verseuse souple	515-517
brosse lave	449
broyeur à glaçons	448
C	
caddy	93, 136, 153-154, 306-309, 334, 452
caddy de table	153-154, 306-309, 334

cadre support inox pour plaque induction	382-384, 393
caisson thermo	36-38
carafe en verre	56-57, 59
casserole	115, 270, 272
casserole à moules	327
cendrier	471-475
cendrier sur pied	475
cercle à gâteaux	509
cercle à mousse rond	507
Chafing Dish	378-379, 381-382, 384-386, 388-390
Chafing Dish Rolltop	385-386, 389
chalumbeau e cuisine	463, 502
chandelier	310-312
chariot	409
chariot de service	408-409
chauffe-plat	394
chauffe-thière	63
chevalets de table	347
chinois	505-506
cloche	16-17, 103, 117-119, 121, 149, 204, 253, 527-531
cloche demi-sphère	332
cloche rolltop	16-17, 117, 120, 253, 392, 526-527
cloche rolltop acier inox	392
coquetier	256, 304
corbeille	367-369, 373
corbeille à baguette	357, 364
corbeille à petits pains	210, 251, 355
corbeille acier inox	373
corbeille de buffet	16, 176, 356, 358, 361-363
corbeille de service	274, 358, 370
corbeille métal	369, 371-375
corbeille polypropylène	353, 356-358, 361-363, 366
coupe-œufs	502
coupe-pâte	501
coupe-pizza	497, 502, 521
couteau à huîtres	498
couteau à tarte	483
couteau à tartiner	501
couteau cannelé	445, 498
couteau cocktail	445, 497
couteau tranche-fromage	498
couteau zesteur	496
couteau zesteur cannelé	496
couvercle	19, 34, 160-161, 171, 237, 241-242, 249, 532-534
couvercle acier inox	325, 400-401
couvercle hermétique	19, 34, 327
couvert à salade	494
cuillère	479-480, 485, 493-495
cuillère à cocktail	442
cuillère à glace	492, 515
cuillère à miel	495
cuillère à salade	255, 483-484
cuillère à sauce	480, 483, 485, 493
cuillère à spaghetti	480, 482
cuillère de service	255, 479-485
cuillère gourmet	268, 493, 495
cuillère party	228, 257-258
cuillère pâtisserie	492
D	
décapsulateur	62, 457
dénoyateur	497
dérouleur de film	514
distributeur de petits pains acier inox	102
distributeur à jus de fruit	20, 39-46, 49-51, 53
distributeur à lait	20, 39-46, 49-52, 460-461
distributeur de boisson isothermique	46

distributeur de boissons	39-47, 452	mesure jigger	439-441	plateau feuille mélamine	201, 217, 244	réciptent bain-marie	506
distributeur de café acier inox	53, 392	Moscow Mule gobelet	429-431	plateau mélamine	25, 71, 163-164, 166, 170, 178-180, 183-186, 188, 191, 193-199, 205-208, 211-217, 219-221, 225-228, 231, 235, 237-239, 253, 262, 290	réciptent de table	409
distributeur de céréales	21, 64-67	moule à boule ronde simple	496	plateau party	123	résistance	53, 385-386, 392-394
distributeur de céréales acero inox	65-66	moule à glaçons	456	plateau self-service et snacks	136, 145, 469	S	
distributeur de désinfectant	98	moule à glaçons en boules	448	plateau sous-verre acier inox	333	sac à lunch	373
distributeur mixte à lait et à jus de fruit	20, 39-46, 49	moule à pizza	519, 521	plateau sushi mélamine	184, 225-226	saucière	331
doseur à sauce	518	moules à flan	509	plateau verre	121	saupoudreuse à épices	291-292
E		moulin à épices	285-290	plateaux réfrigérés	14, 27	seau	413, 511
écumoire	479, 482	moulin à poivre	285-292	plucheur droitier/gaucher	497	seau à champagne	61, 416-417, 419, 421-422
écumoire à friture	505	moulin à sel	285-292, 505	pochette à serviettes	318	seau à glaçons	16, 447
entonnoir	413, 512	multibox	93	pochette couverts	318	seau à glaçons isothermique	416, 446
entonnoir à piston	506	N		poêle en fonte	270	seau à vin	61, 416-417, 419, 421-422
étagère	73, 87-89, 91-92, 131, 233	organisateur „bar caddy“	452	pompe de dosage	518	service à fondue	305, 349, 391, 436
étiquettes	74, 342-345, 348	P		pont de buffet	72	service à parmesan	298
F		pailles	450	porcelaine	379, 384	service à punch	305, 349, 391, 435-436
flacon pulvérisateur	300, 454	panier à œufs	363	porte verres à bière	425	set apéritif	242, 293-300
forme à gateaux	509	panier pour le service sur table	271	porte-addition	333, 470	set cloche à fromage	120
fouet	503	panneau d'avertissement	521, 535	porte-bols	81	set de service	160-161, 209
fourchette à salade	484	papier alimentaire	132, 136, 282, 284	porte-bouteille à vin	425	set de table	314-318
fourchette à viande	480-481, 485	pare-haleine	96, 99, 102	porte-bouteilles	425	set rolltop	120-121, 130
fourchette de service	480-481, 485	paroi de séparation	356	porte-cartes	340-346	set thermo	31
frisette	141, 498, 506	passoire	503-504	porte-cartes de table	342-346	shaker	437-438
G		peleur	496	porte-clés avec cable à enroulement	453	snackbox	254, 269, 283-284, 537
gants de boulanger	510	pelle	495, 511	porte-épices	293-300	sonnette	466
GN bac	15, 24, 111, 396, 398-399, 402-403, 405-407	pelle à farine	510	porte-sachets de sucre	462	soucoupes ardoise naturelle	131, 290
GN bac acier inoxydable	111, 398-399	pelle à gâteau	483, 485	porte-serviettes	155-157	soucoupes liège	520
GN bac pour fours à convection	404	pelle à glaçons	448	pose-cuillère	256, 395	spatule	478, 482-484, 499-500
GN bol mélamine	163, 166, 168, 209	pelle à pizza	502, 510	pot	68-70	spatule coudée spéciale grill	501
GN Chafing Dish	378, 381-382, 385-386, 389-390	petits chevalets de buffet	341, 345, 347	pot à épices	291-292	spatule pâtissière	499
GN cloche	113, 191, 363, 524, 525, 526	pichet	59-60, 460-461, 507	pot à sauce acier inox	74	stand de désinfection	98
GN corbeille	16, 352, 354, 359-361, 363	pichet à café	461	pot à sauce mélamine	74-75	station de panure	513
GN corbeille métal	371-372	pichet à eau	59	pot à sauce porcelaine	75	station pain	94
GN corbeille polypropylène	352, 354, 359-361	pichet à jus de fruit	59-60	pot de moutarde	295	sucrier	301-303, 458-460, 463
GN couvercle	400-403, 406	pichet à lait	460-461	pot verseur universel	302, 458	superbox	22-25
GN égouttoir	401-402	pichet gradué	507-508	poubelle de pédale	475	support à bretzel ou à saucissons	86, 141
GN grille	404	pichet rafraîchisseur	58	poubelle de table	335-336, 338	support à cornets	515
GN planche de service	132	pied pour seau à champagne / vin	418	présentoir	123, 314	support cloche	103
GN plateau	15, 25, 71, 110-113, 127, 144-145, 234, 405	pied pour seau à vin	418	présentoir à assiettes	82, 85, 89-92, 326	support multiple acier inox	104-105
GN plateau acier inox	110-113, 234	pilon muddler	444	présentoir à gâteaux	120, 130, 146-148, 185, 213, 252, 329	support pour brochettes	305
GN plateau ardoise naturelle	24-25, 128-129	pince	449, 479, 486-488, 490-491	présentoir à sandwiches	101	T	
GN plateau buffet acier inox	28	pince à apéritif	488	présentoir buffet	29, 35, 66, 71-74, 76-77, 79-83, 85-92, 100, 102, 106-109, 113, 115, 121, 176, 205, 253, 326, 364, 374-375	tamis	443, 445, 503-504
GN plateau mélamine	25, 71, 163-164, 166, 170, 178, 180, 183-184, 186, 188, 191, 194-195, 197-198, 206, 211-212, 215, 220, 227, 231, 237-239, 243	pince à asperges	486	présentoir buffet acier inox	176	tamis cocktail	443, 445
GN plateau party	123	pince à dresser	449, 489	présentoir buffet bois	71-73, 76-77, 86-88, 109	tapis antidérapant	170
GN plateau porcelaine	127, 405	pince à gâteaux	486, 490-492	présentoir buffet en escalier	79-80, 83	tapis de bar	451
GN présentoir buffet	206, 364	pince à glaçons	449	présentoir buffet froid	14, 18, 27, 30-33, 35-38, 61, 447	tapis égouttoir	451
GN présentoir buffet en escalier	83, 84	pince à homard	502	présentoir buffet froid acier inox	28-29, 33-34	tasse à café	256
GN range couverts	151, 359, 404, 410	pince à salade	479, 486-487, 490	présentoir buffet métal	73, 79-83, 85, 89-90, 109, 115, 206	tasse à remuer	508
GN set buffet	113, 405, 407	pince à spaghetti	479, 486, 488	presse citron	445-446, 513	tasse mélamine	256
GN support buffet	17, 85	pince presse citron	463	R		théière ASIA	63, 461
gobelet	41-45, 268, 426-428	pince universelle	486	rack porte-verres	418, 433	tire-bouchons	457
gobelet à apéritif	271-276	pinceau pâtissier	513	rack pour planches à découper	515	tour de service	106
gourde	536	pique-bons	514	rafraîchisseur	21, 62, 453	truelle de service	269, 464
gravier thermique	395	planche à découper	15, 23, 94-95, 100, 142, 445	rafraîchisseur de bouteilles	21, 62, 416-417, 419-425, 429, 453	tube pour glaçons	40
H		planche à découper buffet	132, 140-141	rafraîchisseur de caviar	118, 305	V	
housse isotherme	425	planche de service	132-137, 139-141, 276, 279-281, 468	ramasse-miettes	332, 470	vase soliflor	313
J		plaque à induction	378-380, 387, 393	ramequin	223, 248, 250	verre mélangeur	454
jeu de cuillère à mesure	492	plaque à pâtisserie	404, 509	range couverts	21, 105-106, 150-154, 187, 334-337, 339, 364-365, 410-411	verres gourmet	322
L		plat à gâteau acier inox	329-330	range couverts mélamine	105	verseurs continus	455
louche	479-480, 482	plat à gâteau bois	135, 147-148, 328, 330	réchaud à beurre et sauce	305	vitrine de buffet	26-29, 36-37, 97
louche de service	483	plat à gâteau mélamine	146, 252, 329-330	réciptent à pâte	412, 521	vitrine de buffet acier inox	28-29
M		plat à sauter	268			vitrine de comptoir	97, 101
mandoline	506	plat ardoise naturelle	24-25, 128-131, 277-278, 290			W	
marmite	383, 389-390	plat de service	110			Weck-bouteilles	70, 82, 321-326
marmite petite de servir	118, 268, 272-273	plat pour la table	115, 270, 272				
marqueur à la craie liquide	348	plateau	15, 94, 112-119, 124-126, 143-145, 267, 280, 282, 355, 464-470				
		plateau acier inox	15, 112-119, 124, 126, 267, 282, 464-466				
		plateau bois	103, 121, 122, 145, 280, 468-469				
		plateau feuille de palme mélamine	244-245				





Buffet & Display

FRAMES



Die reduzierte, archetypische Formsprache von FRAMES nimmt sich elegant zurück und lässt damit viel Raum für die Inszenierung der Buffet-Speisen. Ein scheinbarer Widerspruch löst sich auf: das Design ist zeitgemäß und zeitlos zugleich.

Design in detail – The classic minimalist visual style of FRAMES is elegantly understated, leaving plenty of potential for creating appealing buffet arrangements. Its design transcends what at first seems to be an irreconcilable paradox, being at once both timeless and highly contemporary.



Kühltablets SET 1 „FRAMES“

cooling plates
bandejas refrigeradas
plateaux réfrigérés



GN 1/1 Basiselement, GN 1/1 Edelstahl Tablett 18/10, Kühlakku
GN 1/1 base element, GN 1/1 stainless steel platter 18/10, cooler
elemento básico GN 1/1, bandeja GN 1/1 de acero inoxidable 18/10, acumulador de frío
élément de base GN 1/1, plateau GN 1/1 inox 18/10, accumulateur de froid

	cm	↑ cm	GN	Farbe / Colour	
12940	53 x 32,5	8,5	1/1		stainless steel
14940	53 x 32,5	8,5	1/1		wenge wood
13940	53 x 32,5	8,5	1/1		maple wood



Kühltablets SET 2 „FRAMES“

cooling plates
bandejas refrigeradas
plateaux réfrigérés



GN 1/1 Basiselement, GN 1/1 Edelstahl Tablett 18/10, Rolltop-Haube, Kühlakku
GN 1/1 base element, GN 1/1 stainless steel platter, rolltop cover, cooler
elemento básico GN 1/1, bandeja GN 1/1 de acero inoxidable 18/10, campana rolltop, acumulador de frío
élément de base GN 1/1, plateau GN 1/1 inox 18/10, cloche rolltop, accumulateur de froid

	cm	↑ cm	GN	Farbe / Colour	
12941	53 x 32,5	27,5	1/1		stainless steel
14941	53 x 32,5	27,5	1/1		wenge wood
13941	53 x 32,5	27,5	1/1		maple wood



Schneidebrett „FRAMES“

chopping Board
tabla para cortar
planche à découper



Ahorn, massiv
maple wood, solid
madera de arce, masivo
bois d'érable, massif

	cm	↑ cm	GN	
13955	53 x 32,5	2,5	1/1	
13960	53 x 32,5	2,5	1/1	gerillt

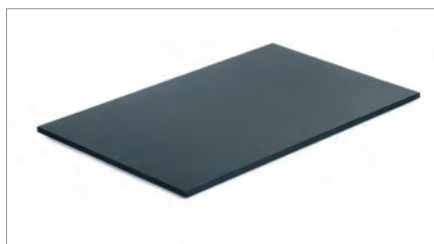

Schneidebrett „FRAMES“

chopping Board
tabla para cortar
planche à découper



	cm	↑ cm	GN
17910	53 x 32,5	2,5	1/1

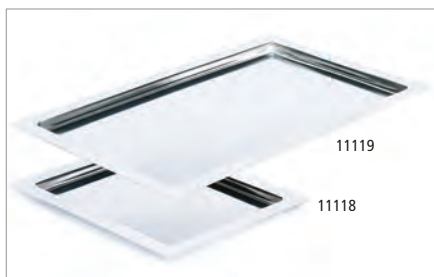

GN Edelstahl Tablett „FRAMES“

GN stainless steel platter
GN bandeja acero inoxidable
GN plateau acier inox



	cm	↑ cm	GN
11119	53,0 x 32,5	2	1/1
11118	32,5 x 26,5	2	1/2



GN Tablett „FRAMES“

GN tray
GN bandeja
GN plateau



	cm	↑ cm	GN
84046	53,0 x 32,5	2	1/1
84047	32,5 x 26,5	2	1/2
84048	32,5 x 17,6	2	1/3



GN Tablett „FRAMES“

GN tray
GN bandeja
GN plateau



	cm	↑ cm	GN
82355	53,0 x 32,5	2	1/1
82356	32,5 x 26,5	2	1/2
82357	32,5 x 17,6	2	1/3



GN Wanne „FRAMES“

GN tray
GN bandeja
GN plateau



	cm	↑ cm	GN
17922	53 x 32,5	8	1/1

FRAMES



Korb „FRAMES“

GN basket
GN cesta
GN corbeille



stabile Ausführung mit Edelstahldraht im Rand zur Stabilisierung
very solid with stainless steel wire frame to stabilize the basket
muy resistente con refuerzo de alambre inox
très résistante avec son fil de renfort inox

	cm	↑ cm	GN
40291	53,0 x 32,5	6,5	1/1
40290	32,5 x 26,5	6,5	1/2
40293	53,0 x 32,5	10,0	1/1
40292	32,5 x 26,5	10,0	1/2



Buffetkorb „FRAMES“

buffet basket
cesta de buffet
corbeille de buffet



Polyrattan, mit Haubenschiene (ohne Haube)
polyrattan, with frame to fix the (without cover)
polyrattan, con fijación para campana (sin campana)
polyrattan, avec fixation pour la cloche (sans cloche)

	∅ cm	↑ cm
40295	40	12,5



GN Basket „FRAMES“

GN basket
cesta GN
corbeille GN



Polyrattan, mit Haubenschiene (ohne Haube)
polyrattan, with frame to fix the (without cover)
polyrattan, con fijación para campana (sin campana)
polyrattan, avec fixation pour la cloche (sans cloche)

	cm	↑ cm
40294	56,5 x 36,0	10



Rolltop-Haube „FRAMES“

rolltop cover
campana abatible
cloche basculante



	∅ cm	↑ cm
18389	38	20



Eisbox „FRAMES“

ice box
bandeja para hielo para buffet
caisse à glaçons pour le buffet



3-teilig: 1 Basiselement Wenge + 1 Polystyrolwanne + 1 Tropfgitter
3 pcs. set: 1 box wenge + 1 plastic deep tray + 1 drainer plate
set de 3: 1 cajón color wengué, 1 cubeta plástico, 1 rejilla
set de 3: 1 caisson couleur wengé, 1 bac plastique, 1 plaque perforée

	cm	↑ cm	GN	Farbe / Colour
14970	53 x 32,5	12,5	1/1	■



GN 1/1 Rolltop-Haube „FRAMES“

GN 1/1 rolltop cover
GN 1/1 campana abatible
GN 1/1 cloche basculante



verchromter Zinkdruckguss-Griff

chrome plated metal handle
mango cromado de fundición a presión de zinc
poignée en zinc moulé sous pression chromé

	cm	↑ cm	GN
11018	53 x 32,5	17	1/1



Besteck- / Universal-Box, 2-teilig „FRAMES“

cutlery tray, 2 pcs.
cubertero o cajón multi-usos, 2pz.
caisson à couverts ou multi-usages



Buche massiv, Wenge, 4 Fächer, inklusive herausnehmbaren Einsatz

wood wenge, 4 compartments
madera de haya maciza, color wengué, 4 compartimentos, separadores removibles
hêtre massif, couleur wengé, 4 compartiments, séparateurs amovibles

	cm	↑ cm	GN	Farbe / Colour
14956	53 x 32,5	11	1/1	■

Einsatz für GN 1/1 „FRAMES“ / insert for GN1/1 „FRAMES“ / interior para GN1/1 „FRAMES“ / insert pour GN1/1 „FRAMES“

	cm	↑ cm	Farbe / Colour
14954	48,5 x 28	8	■



vielseitig einsetzbar für alle GN 1/1 Artikel

passendes Kühltablett Set

Gestell für GN 1/1 „FRAMES“

serving stand
cubertero o cajón multi-usos
caisson à couverts ou multi-usages



Buche massiv, Wenge

wood, wenge
madera de haya maciza, wengué
hêtre massif, wengé

	cm	↑ cm	Farbe / Colour
14953	57,5 x 27,5	22	■



passendes Kühltablett Set



passende Besteck / Universal-Box GN 1/1



Mit hohem Anspruch an Design und Funktionalität haben wir das Buffet-System „Bridge“ für Sie entwickelt. Die in den Holzoberflächen Ahorn und Wenge erhältlichen Artikel sind in ihren Höhen und ihren Volumina optimal aufeinander abgestimmt und gewährleisten einen einfachen und sicheren Umgang in Ihrem Gastronomiealltag.

The collection “Bridge” is bringing perfectly coordinated components for an uncomplicated and organized buffet system, finalizing in an unique buffet scenery. All pieces combine perfectly with one another in their variations of sizes and volumes. The wooden items are available in 2 colors, maple or wenge. A simple and safe handling is guaranteed.

Una colección universal para un buffet único: un Sistema funcional y fácil de componer, asociado a la elegancia de su exclusivo diseño. Los elementos se combinan a la perfección entre variaciones de Alturas y volúmenes, realizando sus propuestas y composiciones culinarias y modelando el paisaje del buffet. Las piezas están disponibles en 2 colores, wengué o arce. Manejo sencillo y seguro.

Une collection universelle pour une présentation unique de votre buffet: fonctionnel et facile à composer, ce système est à la fois pratique, simple et spectaculaire par son élégant design. Les différents éléments se marient à la perfection pour construire sans difficulté différentes compositions, variant les hauteurs et les volumes et mettant en valeur vos créations culinaires. Les pièces sont disponibles en deux couleurs, bois wengué ou érable.



Kühlbox „BRIDGE“
refrigerated buffet display
set de buffet refrigerado
présentoir buffet froid



Set bestehend aus: 1 Gestell aus Ahorn oder Wenge, 1 Behälter aus Kunststoff, 1 GN1/1 Tablett aus Melamin, 1 Kühlakku, 1 Rolltophaube (fix montiert)
set consists of: 1 base element maple or wenge, 1 plastic insert black, 1 GN1/1 tray melamine, 1 cooler, 1 cover (fixed)
set compuesto por: 1 soporte de madera arce o wengué, 1 cubeta de plástico, 1 bandeja de melamina GN 1/1, 1 acumulador de frío, 1 campana rolltop (fija)
set composé de: 1 support en bois érable ou wengué, 1 bac plastique, 1 plat en mélamine GN 1/1, 1 accumulateur de froid, 1 cloche rolltop (fixe)

	cm	↑ cm	Farbe / Colour	
13990	63,5 x 42,5	31		ahorn wood
14990	63,5 x 42,5	31		wenge wood



Kühlschale „BRIDGE“

cooling bowl
bol refrigerado
bol réfrigéré



4-teilig: 1 Gestell aus Ahorn oder Wenge, 1 Behälter aus Edelstahl,
1 Schale aus Melamin (Ø 14 cm o. 23 cm), 1 Kühlakku

4 pcs.: 1 base element maple or wenge, 1 bowl stainless steel,
1 bowl melamine (Ø 14 o. 23 cm), 1 cooler

set de 4: 1 soporte de madera arce o wengué, 1 cuenco

de acero inoxidable, 1 cuenco de melamina (ø 14 cm o 23 cm), 1 acumulador de frío

set de 4: 1 support en bois érable ou wengé, 1 bol en acier inox, 1 bol en mélamine
(ø 14 cm ou 23 cm), 1 accumulateur de froid

	cm	↑ cm	ltr.	Farbe / Colour
13980	18,5 x 18,5	10	0,5	
13981	27,5 x 27,5	14	2,5	

	cm	↑ cm	ltr.	Farbe / Colour
14980	18,5 x 18,5	10	0,5	
14981	27,5 x 27,5	14	2,5	



Edelstahlschale „BRIDGE“

stainless steel bowl
cuenco acero inoxidable
bol acier inoxydable



	Ø cm	↑ cm
30050	14	8,5
30052	23	13,5



Schale „CASUAL MAXI“

bowl
cuenco
bol



	Ø cm	↑ cm	ltr.	Farbe / Colour
83700	14	6,5	0,5	
83702	23	10,5	2,5	

	Ø cm	↑ cm	ltr.	Farbe / Colour
83701	14	6,5	0,5	
83703	23	10,5	2,5	



Frischhaltecover

airtight cover
tapa hermética
couvercle hermétique



	Ø cm
10890	14
10887	23

Kühlakku / cooler / acumulador de frío / accumulateur de froid

	Ø cm	↑ cm
10661	10,5	2,0
10777	15,0	2,5



Milchdispenser „BRIDGE“

milk dispenser
dispensador de leche
distributeur à lait



Edelstahl Dispenser mit 1 Kühlakku im Standfuß inkl. touchless adapter

stainless steel dispenser with 1 cooling element in stand incl. touchless adapter
dispensador de acero inoxidable con 1 acumulador de frío en la base y con adaptador sin contacto para grifo
distributeur en acier inox avec 1 accumulateur de froid dans le socle et avec adaptateur sans contact manuel

	cm	↑ cm	ltr.	Farbe / Colour	
10836	31 x 20	39	3		Ahorn / maple
10838	39 x 22	45	5		Ahorn / maple



Milchdispenser „BRIDGE“

milk dispenser
dispensador de leche
distributeur à lait



Edelstahl Dispenser mit 1 Kühlakku im Standfuß inkl. touchless adapter

stainless steel dispenser with 1 cooling element in stand incl. touchless adapter
dispensador de acero inoxidable con 1 acumulador de frío en la base y con adaptador sin contacto para grifo
distributeur en acier inox avec 1 accumulateur de froid dans le socle et avec adaptateur sans contact manuel

	cm	↑ cm	ltr.	Farbe / Colour	
10837	31 x 20	39	3		Buche / beech
10839	39 x 22	45	5		Buche / beech



Saftdispenser „BRIDGE“

juice dispenser
dispensador de zumo
distributeur à jus



Kühlung durch 2 Kühlakkus von oben und unten

cooling with 2 cooling elements from the top and base
2 acum. de frío 1 en la base y 1 en la tapa
2 plaques de froid 1 dans le couvercle, 1 dans le socle

	cm	↑ cm	ltr.	Farbe / Colour	
10870	31,0 x 20	42	4		Ahorn / maple
10871	35,5 x 22	50	6		Ahorn / maple

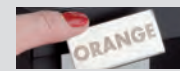

inkl. 3 Magnetschilder: ORANGE, APPLE, GRAPEFRUIT
including 3 magnetic signs: ORANGE, APPLE, GRAPEFRUIT



Saftdispenser „BRIDGE“

juice dispenser
dispensador de zumo
distributeur à jus



Kühlung durch 2 Kühlakkus von oben und unten

cooling with 2 cooling elements from the top and base
2 acum. de frío 1 en la base y 1 en la tapa
2 plaques de froid 1 dans le couvercle, 1 dans le socle

	cm	↑ cm	ltr.	Farbe / Colour	
10872	31,0 x 20	42	4		Wenge / wenge
10873	35,5 x 22	50	6		Wenge / wenge



inkl. 3 Magnetschilder: ORANGE, APPLE, GRAPEFRUIT
including 3 magnetic signs: ORANGE, APPLE, GRAPEFRUIT



4,5 ltr.

Cerealienspender „BRIDGE“

cereal dispenser
dispensador de cereales
distributeur de céréales



Behälter herausnehmbar, „Feierabend-Deckel“ für das aromadichte Lagern, portionieren durch einfaches Drehen

removable canister, special lid to keep the cereals fresh, easy to use, rotate the button to get the muesli

contenedor movible, tapa especial para mantener los cereales frescos, fácil de usar, se gira el pomo para servir los cereales

réceptif amovible, couvercle spécial pour conserver les céréales, usage facile en tournant le bouton

	cm	↑ cm	ltr.	Farbe / Colour	
13987	21 x 20	55,5	4,5		Ahorn / maple



4,5 ltr.

Cerealienspender „BRIDGE“

cereal dispenser
dispensador de cereales
distributeur de céréales



Behälter herausnehmbar, „Feierabend-Deckel“ für das aromadichte Lagern, portionieren durch einfaches Drehen

removable canister, special lid to keep the cereals fresh, easy to use, rotate the button to get the muesli

contenedor movible, tapa especial para mantener los cereales frescos, fácil de usar, se gira el pomo para servir los cereales

réceptif amovible, couvercle spécial pour conserver les céréales, usage facile en tournant le bouton

	cm	↑ cm	ltr.	Farbe / Colour	
14987	21 x 20	55,5	4,5		Wenge / wenge



14995



13995

Besteckbehälter „BRIDGE“

cutlery organizer
cajón para cubiertos
bac à couverts



2 teiliges Set: 1 Gestell, 1 Besteckbehälter (Nr. 11955), herausnehmbar

2 pcs.: 1 base element, 1 removable plastic container (item 11955)

set de 2: 1 soporte, 1 cajón para cubiertos (ref. 11955), extraíble

set de 2: 1 support, 1 bac à couverts (réf. 11955), amovible

	cm	↑ cm	Farbe / Colour	
14995	57,7 x 37	12		Wenge / wenge
13995	57,5 x 37	12		Ahorn / maple



14985



13985

Flaschenkühler „BRIDGE“

bottle cooler
enfriador
refraîchisseur



2-teiliges Set, bestehend aus: 1 Gestell, 1 Behälter aus Edelstahl (doppelwandig)

2 pcs.: 1 base element, 1 bowl stainless steel (double-wall)

set de 2: 1 soporte, 1 cuenco de acero inoxidable (doble pared)

set de 2: 1 support, 1 bol en acier inox (double paroid)

	cm	↑ cm	Farbe / Colour	
14985	35 x 35	19		Wenge / wenge
13985	35 x 35	19		Ahorn / maple

SUPERBOX

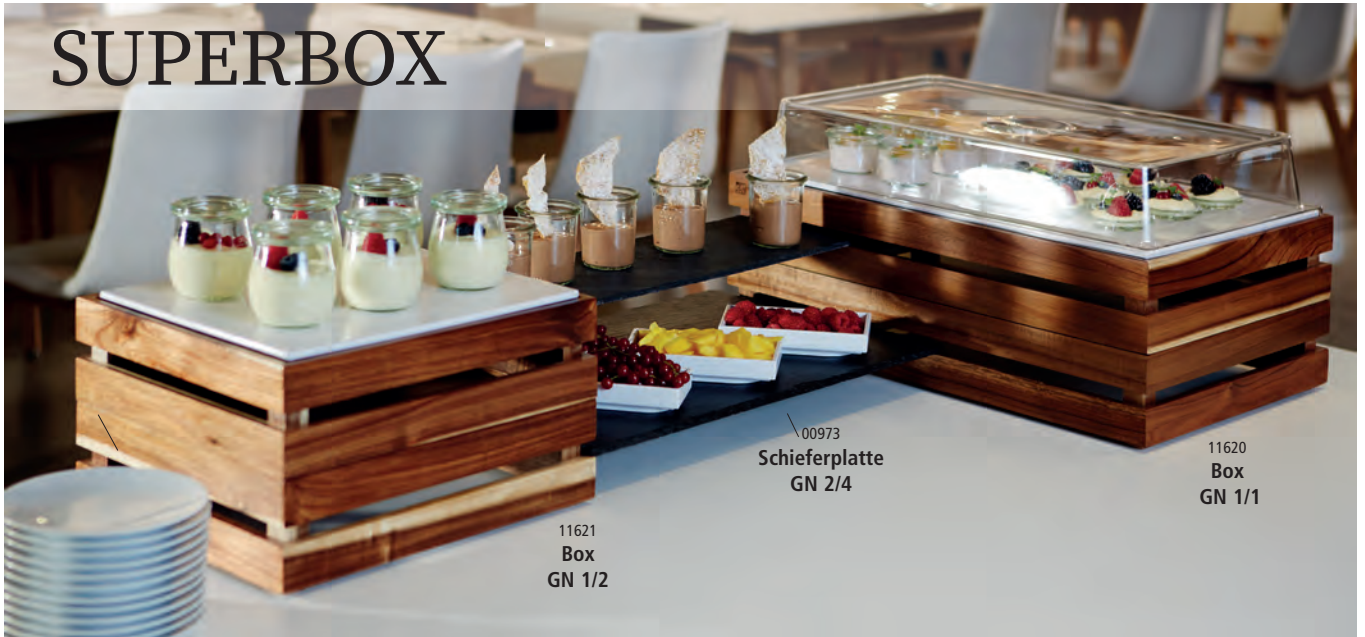

11621
Box
GN 1/2

00973
Schieferplatte
GN 2/4

11620
Box
GN 1/1

Die stapelbaren Wendeboxen lassen sich rutschfest stapeln und mit flachen GN Platten verbinden und einzeln nutzen. Individuell können Buffetlandschaften gebaut werden.

The stackable and non-slip reversible boxes can be connected to flat GN trays and can also be used individually. Different and individual buffet sceneries can be built up.

Las cajas girable y apilables son antideslizantes y se pueden conectar con bandejas planas GN o utilizar individualmente. Se pueden construir diferentes paisajes de buffet muy individuales.

Les boîtes de tournage empilables sont antiglissantes et peuvent être connectées avec des plateaux plats GN ou utilisées individuellement. Des paysages de buffet très personnalisés peuvent être construits.



11626

GN 1/1 „SUPERBOX“

Akazienholz / acacia wood / madera de acacia / bois d'acacia



	cm	↑ cm	Farbe / Colour
11620	55,5 x 35	10,5	
11626	55,5 x 35	10,5	



11623

11629

GN 2/4 „SUPERBOX“

Akazienholz / acacia wood / madera de acacia / bois d'acacia



	cm	↑ cm	Farbe / Colour
11623	55,5 x 18,5	10,5	
11629	55,5 x 18,5	10,5	



11627

GN 1/2 „SUPERBOX“

Akazienholz / acacia wood / madera de acacia / bois d'acacia



	cm	↑ cm	Farbe / Colour
11621	35 x 29	10,5	
11627	35 x 29	10,5	



11622

GN 1/4 „SUPERBOX“

Akazienholz / acacia wood / madera de acacia / bois d'acacia



	cm	↑ cm	Farbe / Colour
11622	29 x 18,5	10,5	
11628	29 x 18,5	10,5	



GN „SUPERBOX“

Akazienholz
acacia wood
madera de acacia
bois d'acacia



	cm	↑ cm	GN	Farbe / Colour
11721	55,5 x 35,0	20	1/1	
11723	55,5 x 35,0	20	1/1	
11620	55,5 x 35,0	10,5	1/1	
11626	55,5 x 35,0	10,5	1/1	
11722	35,0 x 29,0	20	1/2	
11724	35,0 x 29,0	20	1/2	
11621	35,0 x 29,0	10,5	1/2	
11627	35,0 x 29,0	10,5	1/2	

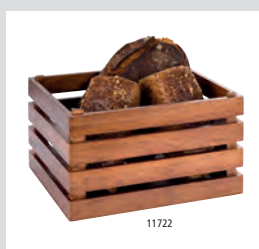

Präsentationsmöglichkeiten
presentation examples



mit herausnehmbarem Krümfach
with removable crump shelf

Brottschneidebrett

cutting board
tabla para cortar
planche à découper



Schneidebrett aus geöltem Walnussholz mit Antirutsch-Füßchen
with non-slip-feet oiled walnut wood cutting board
tabla de cortar de nogal engrasada con pies antideslizantes
planche à découper en bois de noyer huilé avec pieds antidérapants

	cm	↑ cm	GN
00911	35,4 x 32,5	3,5	2/3

SUPERBOX



GN „SUPERBOX VINTAGE“



Akazienholz
 acacia wood
 madera de acacia
 bois d'acacia

	cm	↑ cm	GN	Farbe / Colour
11715	55,5 x 35,0	10,5	1/1	■
11716	35,0 x 29,0	10,5	1/2	■
11717	29,0 x 18,5	10,5	1/4	■
11718	55,0 x 18,5	10,5	2/4	■



Präsentationsmöglichkeiten
 presentation examples



GN Naturschieferplatten

GN natural slate tray
 GN bandeja de pizarra natural
 GN plat ardoise naturelle



	cm	GN
00990	53,0 x 32,5	1/1
00991	32,5 x 26,5	1/2
00993	26,5 x 16,2	1/4
00973	53,0 x 16,2	2/4



GN Einsatz „SUPERBOX“

GN insert
 GN bandeja
 GN bac supérieur



	cm	↑ cm	GN	fits to
11616	53,0 x 32,5	8,5	1/1	11620, 11626, 11700, 11715
11617	32,5 x 26,5	8,5	1/2	11621, 11627, 11701, 11716





GN „SUPERBOX VINTAGE“



Leichtes Holz, Tannenholz
fir wood
madera de abeto
bois sapin

	cm	↑ cm	GN
11700	55,5 x 35,0	10,5	1/1
11701	35,0 x 29,0	10,5	1/2
11702	29,0 x 18,5	10,5	1/4
11703	55,0 x 18,5	10,5	2/4



GN Tablett „ZERO“



GN tray
GN bandeja
GN plateau

	cm	↑ cm	GN	Farbe / Colour
84185	53,0 x 32,5	1,5	1/1	White
84195	53,0 x 32,5	1,5	1/1	Black
84186	32,5 x 26,5	1,5	1/2	White
84196	32,5 x 26,5	1,5	1/2	Black
84188	26,5 x 16,2	1,5	1/4	White
84198	26,5 x 16,2	1,5	1/4	Black
84189	53,0 x 16,2	1,5	2/4	White
84199	53,0 x 16,2	1,5	2/4	Black



mit Antirutschfüßchen
with non-slip feet



GN Naturschieferplatten



GN natural slate tray
GN bandeja de pizarra natural
GN plat ardoise naturelle

	cm	GN
00990	53,0 x 32,5	1/1
00991	32,5 x 26,5	1/2
00993	26,5 x 16,2	1/4
00973	53,0 x 16,2	2/4

COOLING DISPLAY



Buffetvitrine „TOP FRESH GN 1/1“

refrigerated buffet display
expositor buffet frío
plateau buffet froid



4-teilig: 1 Holzbox mit Kunststoffwanne + 1 Tablett GN 1/1 + 2 Kühlakkus

4 pcs.: 1 woodbox with plastic insert + 1 stainless tray GN 1/1 + 2 coolers

set de 4: 1 base madera + 1 bandeja inox GN 1/1 + 2 acumuladores de frío

set de 4: 1 base bois + 1 plateau inox GN 1/1 + 2 accus de froid (cloche non incluse)

	cm	↑ cm
11540	60 x 41	5

GN Rolltophaube / GN rolltop cover / GN campana rolltop / GN cloche rolltop

	cm	↑ cm	GN
11008	53 x 32,5	19	1/1 Gold-Griff

GN Rolltophaube / GN rolltop cover / GN campana rolltop / GN cloche rolltop

	cm	↑ cm	GN
11010	53 x 32,5	19	1/1 Chrom-Griff

Kühlakku / cooler / acumulador de frío / accumulateur de froid

	cm	↑ cm
10791	25 x 19	2,5



Buffetvitrine „DOPPELDECKER“

cooling buffet display
expositor buffet frío
vitrine buffet



12-teilig: 2 Kästen Buchen-Holz versiegelt + 2 Tablett GN 1/1

+ 4 Kühlakkus + 4 Stangen, ohne Hauben

12 pcs.: 2 beech wood boxes waterproof + 2 trays GN 1/1

+ 4 coolers + 4 fittings, without covers

set de 12: 2 bases madera tratada + 2 bandejas inox GN 1/1

+ 4 enfriadores + 4 pies (campanas no incl.)

set de 12: 2 caissons bois traité (hêtre) + 2 plateaux inox GN 1/1

+ 4 accus + 4 pieds (cloches non incluses)

	cm	↑ cm	
11541	60 x 41	36	verchromte Stäbe / chrome plated fittings pies cromados / pieds chromés

GN Rolltophaube / GN rolltop cover / GN campana rolltop / GN cloche rolltop

	cm	↑ cm	GN
11008	53 x 32,5	19	1/1 Gold-Griff

GN Rolltophaube / GN rolltop cover / GN campana rolltop / GN cloche rolltop

	cm	↑ cm	GN
11010	53 x 32,5	19	1/1 Chrom-Griff

Kühlakku / cooler / acumulador de frío / accumulateur de froid

	cm	↑ cm
10791	25 x 19	2,5



11542

Buche, wasserfest lackiert
beech wood lacquered



18388

11542



10791

Kühl-Akkus halten Ihre Speisen bis zu 6 Stunden kühl
cooling system keeps the food cool for up to 6 hours

Kühltablett „TOP FRESH RUND“
refrigerated buffet display
expositor buffet frío redondo
présentoir buffet



3-teilig: 1 Holzbox mit Kunststoffwanne + 1 Edelstahl-Tablett Ø 38 cm + 1 Kühllakku
3 pcs.: 1 woodbox with plastic insert + 1 stainless tray Ø 38 cm + 1 cooler
set de 3: 1 caja madera + 1 bandeja inox Ø 38 cm + 1 acumulador de frío
set de 3: 1 base bois + 1 plateau inox Ø 38 cm + 1 accumulateur de froid

	Ø cm	↑ cm	
11542	48	6	

Rolltophaube / rolltop cover / campana abatible / cloche basculante

	Ø cm	↑ cm	
18388	38	20	mit verchromtem Kugelgriff

Rolltophaube / rolltop cover / campana abatible / cloche basculante

	Ø cm	↑ cm	
18387	38	20	mit vergoldetem Kugelgriff

Kühllakku / cooler / acumulador de frío / accumulateur de froid

	cm	↑ cm	
10791	25 x 19	2,5	



18388

18388

11543

Buche, wasserfest lackiert
beech wood lacquered



10791

Kühl-Akkus halten Ihre Speisen bis zu 6 Stunden kühl
cooling system keeps the food cool for up to 6 hours

Buffetvitrine „DOPPELDECKER“
double refrigerated buffet display
expositor de buffet redondo doble
présentoir buffet froid, double



11-teilig: 2 Rahmen Buchen-Holz versiegelt + 2 Edelstahl-Tablets Ø 38 cm + 2 Kühllakku + 2 Kunststoffschalen + 3 Stangen, ohne Hauben
11 pcs.: 2 beech wood boxes waterproof + 2 stainless trays Ø 38 cm + 2 cooler + 2 plastic deep trays + 3 fittings, without covers
set de 11: 2 bases madera + 2 bandejas inox aprox. 38cm + 2 acumuladores + 2 cubetas plástico + 3 varas (campanas no incl.)
set de 11: 2 caissons bois traité (hêtre) + 2 plateaux inox approx. 38 cm + 2 accus + 2 bacs plastique + 3 barres (cloches non incluses)

	Ø cm	↑ cm	
11543	48	38	verchromte Stäbe / chrome fittings pies cromados / pieds chromés

Rolltophaube / rolltop cover / campana abatible / cloche basculante

	Ø cm	↑ cm	
18388	38	20	mit verchromtem Kugelgriff

Rolltophaube / rolltop cover / campana abatible / cloche basculante

	Ø cm	↑ cm	
18387	38	20	mit vergoldetem Kugelgriff

Kühllakku / cooler / acumulador de frío / accumulateur de froid

	cm	↑ cm	
10791	25 x 19	2,5	

COOLING TRAY



Buffetvitrine „TOP FRESH GN 1/1“

cooling buffet display
expositor buffet frío
présentoir buffet



5-teilig: 1 Edelstahl-Tablett GN 1/1 + 2 Kühllakku + 1 Edelstahl-Schale
+ 1 Acrylrahmen, ohne Haube

5 pcs.: 1 stainless tray GN 1/1 + 2 cooler + 1 stainless deep tray
+ 1 frame acrylic, without cover

set de 5: 1 bandeja inox GN 1/1 + 2 acumuladores + 1 cubeta inox
+ 1 marco metacrilato (campana no incl.)

set de 5: 1 plateau inox GN 1/1 + 2 accus. de froid + 1 bac inox
+ 1 cadre plexi (cloche non-incl.)

	cm	↑ cm
11510	61 x 38	8

GN Rolltophaube / GN rolltop cover / GN campana rolltop / GN cloche rolltop

	cm	↑ cm	GN
11010	53 x 32,5	19	1/1

Kühllakku / cooler / acumulador de frío / accumulateur de froid

	cm	↑ cm
10791	25 x 19	2,5



Buffetvitrine „DOPPELDECKER GN1/1“

cooling buffet display
expositor buffet frío
présentoir buffet



14-teilig: 2 Edelstahl-Tablets GN 1/1 + 4 Kühllakku + 2 Edelstahl-Schale
+ 2 Acrylrahmen + 4 verchromte Stangen, ohne Hauben

14 pcs.: 2 stainless tray GN 1/1 + 4 cooler + 2 stainless deep trays
+ 2 frames acrylic + 4 chrome plated fittings, without covers

set de 14: 2 bandejas inox GN 1/1 + 4 acum. de frío 2 cubetas inox
+ 2 bases metacrilato + 4 varas cromadas (sin las campanas)

set de 14: 2 plateaux inox GN 1/1 + 4 accus 2 bacs inox + 2 cadres plexi
+ 4 barres chromées (sans les cloches)

	cm	↑ cm
11514	61 x 38	33

GN Rolltophaube / GN rolltop cover / GN campana rolltop / GN cloche rolltop

	cm	↑ cm	GN
11010	53 x 32,5	19	1/1

Kühllakku / cooler / acumulador de frío / accumulateur de froid

	cm	↑ cm
10791	25 x 19	2,5



Kühl-Akkus halten Ihre Speisen bis zu 6 Stunden kühl
cooling system keeps the food cool for up to 6 hours

Kühltablett „TOP FRESH RUND“

cooling plate
expositor buffet frío
présentoir buffet



4-teilig: 1 Edelstahl-Tablett Ø 38 cm + 2 Kühllakku + 1 Edelstahl-Schale + 1 Acrylrahmen, ohne Haube

4 pcs.: 1 stainless tray Ø 38 cm + 2 cooler + 1 stainless deep tray + 1 frame acrylic, without cover
set de 4: 1 bandeja inox 38cm + 2 acum. de frío + 1 cubeta inox + 1 base metacrilato (campana no incluida)
set de 4: 1 plateau inox 38cm + 2 accum. de froid + 1 bac inox + 1 base plexi (cloche non incl.)

	Ø cm	↑ cm
11512	43,5	5,5

Rolltophaube / rolltop cover / campana abatible / cloche basculante

	Ø cm	↑ cm	
18388	38	20	mit verchromtem Kugelgriff

Kühllakku / cooler / acumulador de frío / accumulateur de froid

	cm	↑ cm	pcs.
11101	16 x 7,5	2	4



Kühl-Akkus halten Ihre Speisen bis zu 6 Stunden kühl
cooling system keeps the food cool for up to 6 hours

Buffetvitrine „DOPPELDECKER“

cooling plate
expositor de buffet doble redondo
présentoir buffet



13-teilig: 2 Edelstahl-Tablets Ø 38 cm + 4 Kühllakku + 2 Edelstahl-Schalen + 2 Acrylrahmen + 3 verchromte Stangen, ohne Hauben

13 pcs.: 2 stainless trays Ø 38 cm + 4 cooler + 2 stainless deep tray + 2 frames acrylic + 3 chrome plated fittings, without covers
set de 13: 2 bandejas inox 38 cm + 4 acumuladores de frío + 3 varas cromadas + 2 bases + 2 bandejas, campana no incluida
set de 13: 2 plateaux inox 38cm + 4 accum. de froid + 2 bacs inox + 2 bases plexi + 3 barres chromées (cloche non incl.)

	Ø cm	↑ cm
11516	43,5	33

Rolltophaube / rolltop cover / campana abatible / cloche basculante

	Ø cm	↑ cm	
18388	38	20	mit verchromtem Kugelgriff

Kühllakku / cooler / acumulador de frío / accumulateur de froid

	cm	↑ cm	pcs.
11101	16 x 7,5	2	4

COOLING DISPLAY



Kühlbox „TOP FRESH GN 1/1“

cooling plate
bandeja de frío
présentoir buffet réfrigéré



4-teilig: 1 Kühlbox + 1 Tablett GN 1/1 + 2 Kühlakkus, ohne Haube

4 pcs.: 1 box + 1 tray GN 1/1 + 2 coolers, without cover

set de 4: 1 caja plástico blanco + 1 bandeja GN 1/1 + 2 acum. de frío, campana no incluida

set de 4: 1 caisson plastique blanc + 1 plateau GN 1/1 + 2 accum. de froid, cloche non incl.

	cm	↑ cm	Farbe / Colour
11503	56,5 x 35	6,5	White
11505	56,5 x 35	6,5	Black

GN Rolltophaube / GN rolltop cover / GN campana rolltop / GN cloche rolltop

	cm	↑ cm	GN
11008	53,0 x 32,5	19	1/1 mit vergoldetem Kreuzgriff

GN Rolltophaube / GN rolltop cover / GN campana rolltop / GN cloche rolltop

	cm	↑ cm	GN
11010	53 x 32,5	19	1/1 mit verchromtem Kreuzgriff

Kühlakku / cooler / acumulador de frío / accumulateur de froid

	cm	↑ cm
10791	25 x 19	2,5

GN Edelstahl-Tablett „PROFI LINE“ / GN tray / GN bandeja / GN plat empilable système catering

	cm	↑ cm	GN
11100	53 x 32,5	1,5	1/1



Kühlbox „TOP FRESH GN 1/1“

cooling box
expositor buffet frío
présentoir buffet



4-teilig: 1 Kühlbox + Tablett GN 1/1 + 2 Kühlakkus, ohne Haube

4 pcs.: 1 box + 1 tray GN 1/1 + 2 cooler, without rolltop cover

set de 4: 1 cajón + 1 bandeja GN 1/1 + 2 enfriadores, campana no incluida

set de 4: 1 caisson inférieur + 1 plateau GN 1/1 + 2 accus, cloche non incluse

	cm	↑ cm
11590	56,5 x 36	8,5

GN Rolltophaube / GN rolltop cover / GN campana rolltop / GN cloche rolltop

	cm	↑ cm	GN
11008	53 x 32,5	19	1/1

GN Rolltophaube / GN rolltop cover / GN campana rolltop / GN cloche rolltop

	cm	↑ cm	GN
11010	53 x 32,5	19	1/1

Kühlakku / cooler / acumulador de frío / accumulateur de froid

	cm	↑ cm
10791	25 x 19	2,5



18388

11538

10791

Kühl-Akkus halten Ihre Speisen bis zu 6 Stunden kühl
cooling system keeps the food cool for up to 6 hours

Kühlbox „TOP FRESH SET“

cooling plate
bandeja de frío
set réfrigère



3-teilig: 1 Box + 1 Tablett Ø 38 cm + 1 Kühllakku, ohne Haube
3 pcs.: 1 box + 1 tray Ø 38 cm + 1 cooler, without cover
set de 3: 1 caja + 1 bandeja Ø 38 cm + 1 enfriador, sin tapa
set de 3: 1 caisson + 1 plateau Ø 38 cm + 1 accum. (livré sans la cloche)

	Ø cm	↑ cm	Farbe / Colour
11538	42	6	white
11533	42	6	black

Rolltophaube / rolltop cover / campana abatible / cloche basculante

	Ø cm	↑ cm	
18388	38	20	mit verchromtem Kugelgriff

Kühllakku / cooler / acumulador de frío / accumulateur de froid

	cm	↑ cm	
10791	25 x 19	2,5	



18388

09082

11101

Kühl-Akkus halten Ihre Speisen bis zu 6 Stunden kühl
cooling system keeps the food cool for up to 6 hours

Thermo-Set

thermo set
bandeja isotérmica
set thermo



5-teilig: 1 Tablett tief + 1 Tablett flach + 2 Kühllakkus + 1 Rolltophaube
5 pcs.: 1 deep tray + 1 tray + 2 cooler + 1 rolltop cover
set de 5: 1 bandeja inferior + 1 bandeja + 2 acumuladores frío + campana
set de 5: 1 plateau creux + 1 plateau plat + 2 accum. + 1 cloche rolltop

	Ø cm	↑ cm	
09082	38	24	

Rolltophaube / rolltop cover / campana abatible / cloche basculante

	Ø cm	↑ cm	
18388	38	20	mit verchromtem Kugelgriff

Kühllakku / cooler / acumulador de frío / accumulateur de froid

	cm	↑ cm	pcs.
11101	16 x 7,5	2	4



09083

11101

Kühl-Akkus halten Ihre Speisen bis zu 6 Stunden kühl
cooling system keeps the food cool for up to 6 hours

Thermo-Set

thermo set
porta tartas refrigerado
porte-gâteau réfrigéré



4-teilig: 1 Tablett tief auf Fuß + 1 Tablett flach + 2 Kühllakkus
4 pcs.: 1 deep tray with feet + 1 tray + 2 cooler
set de 4: 1 bandeja honda con pie + 1 bandeja + 2 acumuladores de frío
set de 4: 1 plateau creux avec pied + 1 plateau plat + 2 accum.

	Ø cm	↑ cm	
09083	38	14,5	

Rolltophaube / rolltop cover / campana abatible / cloche basculante

	Ø cm	↑ cm	
18388	38	20	mit verchromtem Kugelgriff

Kühllakku / cooler / acumulador de frío / accumulateur de froid

	cm	↑ cm	pcs.
11101	16 x 7,5	2	4

COOLING DISPLAY



Kühlschale Mini Holz „TOP FRESH“

cool bowl mini holz
bol refrigerado mini madera
bol réfrigéré MINI bois



4-teilig: 1 Fuß Buchen-Holz versiegelt + 1 Schale + 1 Kühlakku
+ 1 klappbarer Deckel mit Beschriftungsschild

4 pcs.: 1 column with food base (beech) + 1 bowl
+ 1 cooler + 1 cover with card, hinged

set de 4: 1 bol polycarbonato + 1 base madera
+ 1 acum. de frío + 1 tapa con bisagra y porta etiqueta

set de 4 : 1 base en bois + 1 accum + 1 bol polycarbonate
+ 1 couvercle à charnière avec porte-étiquette

	Ø cm	↑ cm	ltr.
11812	14	9,0	0,6
11813	14	11,5	1,0

Ersatzschale / spare bowl / recambio bol / bol de rechange

	Ø cm	↑ cm
11811	14	6,5
11816	14	9,0

Schutzdeckel mit Löffelaussparung / cover / tapa / couvercle

	Ø cm
11868	14,5

Kühlakku / cooler / acumulador de frío / accumulateur de froid

	Ø cm	↑ cm
10661	10,5	2



Kühlschale Maxi Holz „TOP FRESH“

cool bowl maxi holz
bol refrigerado MAXI madera
bol réfrigéré MAXI bois



4-teilig: 1 Fuß Buchen-Holz versiegelt + 1 Schale + 1 Kühlakku
+ 1 klappbarer Deckel mit Beschriftungsschild

4 pcs.: 1 column with food base (beech) + 1 bowl
+ 1 cooler + 1 cover with card, hinged

set de 4: 1 bol + 1 base madera + 1 acumulador de frío
+ 1 tapa con bisagra y porta etiqueta

set de 4: 1 base en bois + 1 accum. + 1 bol
+ 1 couvercle à charnière avec porte-étiquette

	Ø cm	↑ cm	ltr.
11817	22	14	2,5
11818	22	18	4,0

Ersatzschale / spare bowl / recambio bol / bol de rechange

	Ø cm	↑ cm
11846	22	8
11848	22	12

Schutzdeckel mit Löffelaussparung / cover / tapa / couvercle

	Ø cm
11878	23,5

Kühlakku / cooler / acumulador de frío / accumulateur de froid

	Ø cm	↑ cm
10777	15	2,5



Kühlschale Mini „TOP FRESH“

cool bowl mini
bol refrigerado MINI
bol réfrigéré MINI



4-teilig: 1 Edelstahlgefäß matt + 1 Kühlakku + 1 Schale + 1 klappbarer Deckel mit Beschriftungsschild

4 pcs.: 1 column satin polished finish + 1 cooler + 1 bowl + 1 cover with card, hinged

set de 4: 1 base acabado efecto satinado + 1 acumulador de frío + 1 tapa con porta etiqueta + 1 bol

set de 4: 1 base inox mat satiné + 1 accum. de froid + 1 couvercle à charnière avec porte étiquette + 1 bol

	Ø cm	↑ cm	ltr.
11810	14	9,0	0,6
11815	14	11,5	1,0

Ersatzschale / spare bowl / recambio bol / bol de rechange

	Ø cm	↑ cm
11811	14	6,5
11816	14	9,0

Schutzdeckel mit Löffelaussparung / cover / tapa / couvercle

	Ø cm
11868	14,5

Kühlakku / cooler / acumulador de frío / accumulateur de froid

	Ø cm	↑ cm
10661	10,5	2



Kühlschale Maxi „TOP FRESH“

cool bowl maxi
bol refrigerado MAXI
bol réfrigéré MAXI



4-teilig: 1 Gefäß hochglanzpoliert + 1 Kühlakku + 1 Schale + 1 klappbarer Deckel mit Beschriftungsschild

4 pcs.: 1 column mirror polished finish + 1 cooler + 1 bowl + 1 cover with card, hinged

set de 4: 1 base pulido acabado efecto espejo + 1 acumulador de frío + 1 tapa con porta etiqueta + 1 bol

set de 4: 1 base inox poli brillant + 1 accum. + 1 récipient + 1 couvercle à charnière avec porte-étiquette

	Ø cm	↑ cm	ltr.
11847	22	14	2,5
11849	22	18	4,0

Ersatzschale / spare bowl / recambio bol / bol de rechange

	Ø cm	↑ cm
11846	22	8
11848	22	12

Schutzdeckel mit Löffelaussparung / cover / tapa / couvercle

	Ø cm
11878	23,5

Kühlakku / cooler / acumulador de frío / accumulateur de froid

	Ø cm	↑ cm
10777	15	2,5

COOLING DISPLAY

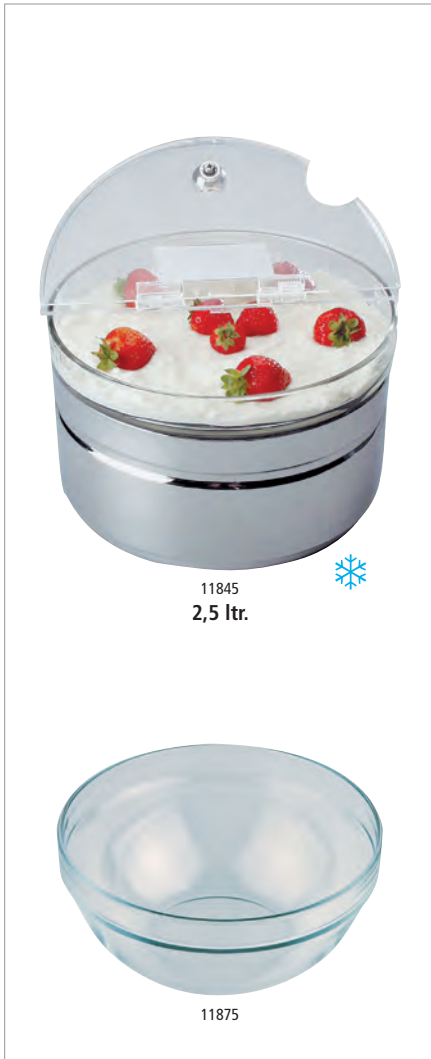

Kühlschale Maxi „TOP FRESH“

cool bowl maxi
cuenco refrigerado MAXI
bol réfrigéré MAXI



4-teilig: 1 Gefäß hochglanzpoliert + 1 Kühlakku + 1 Glasschale
+ 1 klappbarer Deckel mit Beschriftungsschild

4 pcs.: 1 column mirror polished finish + 1 cooler
+ 1 glass bowl + 1 cover with card, hinged

set de 4: 1 base pulido acabado efecto espejo
+ 1 acumulador de frío + 1 tapa con porta etiqueta + 1 bol vidrio

set de 4 : 1 base inox poli brillante + 1 accum.
+ 1 bol verre + 1 couvercle à charnière avec porte-étiquette

	Ø cm	↑ cm	ltr.
11845	23	14	2,5

Schale / bowl / cuenco / bol

	Ø cm	↑ cm	ltr.
11875	23	10,5	2,5

Schutzdeckel mit Löffelaussparung / cover / tapa / couvercle

	Ø cm
11878	23,5

Kühlakku / cooler / acumulador de frío / accumulateur de froid

	Ø cm	↑ cm
10777	15	2,5



Schale „CASUAL MAXI“

bowl
cuenco
bol



	Ø cm	↑ cm	ltr.	Farbe / Colour
83696	10	4,5	0,15	White
83698	12	5,5	0,25	White
83700	14	6,5	0,50	White
83704	20	9,2	1,80	White
83702	23	10,5	2,50	White

	Ø cm	↑ cm	ltr.	Farbe / Colour
83697	10	4,5	0,15	Black
83699	12	5,5	0,25	Black
83701	14	6,5	0,50	Black
83705	20	9,2	1,80	Black
83703	23	10,5	2,50	Black

Deckel „FLOAT“ mit Löffelaussparung / cover, with notched for spoons / tapa, con espacio para la cuchara / couvercle, avec encoche pour la louche

	Ø cm	↑ cm	fits to
83920	20,5	1,3	83704, 83705



Buffet-Set „FOCUS“

buffet set
set de buffet
présentoir pour le buffet

4-teilig: Box, Tablett, 2 Kühlakkus

4 pcs.: box, tray, 2 cooler
set de 4.: box, bandeja, 2 enfriadores
swt de 4: caisson, 2 plateau, bac



	cm	↑ cm	Farbe / Colour
09000	43,5 x 32,5	6	White
09001	43,5 x 32,5	6	Black

Edelstahltablett / tray / bandeja / plateau

	cm	↑ cm
09010	43,5 x 32,5	1,5

Holzschneidebrett / wooden board / tablero de madera / planche à découper

	cm	↑ cm
09016	43,5 x 32,5	2

Basisteil / base / base / base

	cm	↑ cm	Farbe / Colour
09011	42,5 x 31,5	6	White
09012	42,5 x 31,5	6	Black

Rolltophaube „FOCUS“ / rolltop cover / campana abatible / cloche basculante

	cm	↑ cm
09013	44 x 33,5	17

Kühlakku / cooler / acumulador de frío / accumulateur de froid

	cm	↑ cm
10791	25 x 19	2,5

Kühl-Akkus halten Ihre Speisen bis zu 6 Stunden kühl
cooling system keeps the food cool for up to 6 hours



Buffet-Set „FOCUS“

buffet set
set de buffet
présentoir pour le buffet

3-teilig: Box, Tablett, 1 Kühlakku

3 pcs.: box, tray, 1 cooler
set de 3.: box, bandeja, 1 enfriador
set de 3: caisson, 1 plateau, bac



	Ø cm	↑ cm	Farbe / Colour
09002	38	6	White
09003	38	6	Black

Edelstahltablett / tray / bandeja / plateau

	Ø cm	↑ cm
09020	38	1,5

Basisteil / base / base / base

	Ø cm	↑ cm	Farbe / Colour
09021	37	6	White
09022	37	6	Black

Rolltophaube / rolltop cover / campana abatible / cloche basculante

	Ø cm	↑ cm
09023	38	20

Kühl-Akkus halten Ihre Speisen bis zu 6 Stunden kühl
cooling system keeps the food cool for up to 6 hours

COOLING DISPLAY



09100

09102

90902

11101

Kühl-Akkus halten Ihre Speisen bis zu 6 Stunden kühl
cooling system keeps the food cool for up to 6 hours

Buffetvitrine

showcase
vitrina de buffet
vitrine de buffet



1 transparente Rolltopphaube beidseitig aufklappbar + 1 Schale (ABS)
+ 1 Edelstahl-Tablett 39 x 28 cm + 2 Kühl-Akkus

1 transparent rolltop cover + 1 tray (ABS) + 1 stainless tray 39 x 28 cm + 2 coolers, demountable
1 tapa abatible transparente + 1 bandeja (ABS) + 1 bandeja 39x28cm + 2 enfriadores, desmontable

1 cloche transparente ouverture 2 côtés + 1 caisson (ABS) + 1 plateau inox 39 x 28 cm +
2 accumulateurs de froid, démontable

	cm	↑ cm	Farbe / Colour
09100	44 x 32	20,5	White
09102	44 x 32	20,5	Blue
09104	44 x 32	20,5	Black

Kühlakku / cooler / acumulador de frío / accumulateur de froid

	cm	↑ cm	pcs.
11101	16 x 7,5	2	4

Edelstahl-Tablett / stainless steel tray / bandeja de acero inoxidable / plateau inox

	cm
90902	39 x 28



Servierbeispiel
presentation example



11101

90901

Kühl-Akkus halten Ihre Speisen bis zu 6 Stunden kühl
cooling system keeps the food cool for up to 6 hours

Thermo Tablett-Set

thermo tray
bandeja termo
caisson thermo



1 stabile Schale + 1 Edelstahl-Tablett + 2 Kühlakkus + 1 Frischhaltehaube

1 plastic tray + 1 stainless tray + 2 coolers + 1 cover

1 bandeja de plástico + 1 bandeja inox + 2 acumuladores + 1 campana

1 plateau plastique + 1 plateau inox + 2 accumulateurs de froid + 1 cloche

	cm	↑ cm
09090	43 x 29	14

Kühlakku / cooler / acumulador de frío / accumulateur de froid

	cm	↑ cm	pcs.
11101	16 x 7,5	2	4

Haube / cover / campana / cloche

	cm	↑ cm
90901	43 x 29	14

Edelstahl-Tablett / stainless steel tray / bandeja de acero inoxidable / plateau inox

	cm
90902	39 x 28



Buffetvitrine „DOPPELDECKER“

showcase
vitrina de buffet, 2 alturas
vitrine de buffet double



2 transparente Rolltophauben beidseitig aufklappbar + 2 Schalen (ABS) + 2 Edelstahl-Tablets 39 x 28 cm + 4 Kühl-Akkus, platzsparend lagerbar

2 transparent rolltop cover + 2 trays (ABS) + 2 tray 39 x 28 cm + 4 coolers, demountable, space saving

2 campanas abatibles por ambos lados + 2 bandejas (ABS) + 2 bandejas 39 x 28 cm + 4 acumuladores, desmontable, ahorra espacio

2 cloches transparentes abattantes 2 côtés + 2 caissons (ABS) + 2 plateaux 39 x 28 cm + 4 accumulateurs de froid, gain d'espace

	cm	↑ cm	Farbe / Colour
09200	44 x 32	44	White
09202	44 x 32	44	Blue
09204	44 x 32	44	Black

Kühlakku / cooler / acumulador de frío / accumulateur de froid

	cm	↑ cm	pcs.
11101	16 x 7,5	2	4

Edelstahl-Tablett / stainless steel tray / bandeja de acero inoxidable / plateau inox

	cm
90902	39 x 28



Thermo Tablett-Set

thermo tray
bandeja termo
caisson thermo



1 stabile Schale + 1 Edelstahl-Tablett + 2 Kühlakkus + 1 Frischhaltehaube

1 plastic tray + 1 stainless tray + 2 coolers + 1 cover

1 bandeja de plástico + 1 bandeja inox + 2 acumuladores + 1 campana

1 plateau plastique + 1 plateau inox + 2 accumulateurs de froid + 1 cloche

	Ø cm	↑ cm
09093	35	15

Kühlakku / cooler / acumulador de frío / accumulateur de froid

	cm	↑ cm	pcs.
11101	16 x 7,5	2	4

Kühl-Akkus halten Ihre Speisen bis zu 6 Stunden kühl
cooling system keeps the food cool for up to 6 hours

COOLING DISPLAY



Thermo Tablett-Set, 6-teilig

thermo tray, 6 pcs.
bandeja térmica, set de 6
plateau thermique, set de 6



6 teiliges Set:

- 1 Schale
- 1 Edelstahltablett
- 2 Kühllakkus
- 1 transparente Frischhaltehaube
- 1 Transport- und Tragegurt aus Silikon

6 pcs.:

- 1 plastic tray
- 1 stainless steel tray
- 2 coolers
- 1 transparent cover
- 1 silicone transport and carrying strap

set de 6:

- 1 bandeja de plástico
- 1 bandeja de acero inoxidable
- 2 acumuladores de frío
- 1 campana transparente
- 1 correa de silicona para cierre y transporte

set de 6:

- 1 plateau plastique
- 1 plateau en acier inox
- 2 accumulateurs de froid
- 1 cloche transparente
- 1 sangle en silicone pour fermeture et transport

NEU
inkl.
Transport- und
Tragegurt!

	cm	↑ cm	Farbe / Colour
09091	43 x 29	14	
09090	43 x 29	14	



inkl. 2x Kühl-Akkus
incl. 2x cooler keeps



Thermo Tablett-Set, 6-teilig

thermo tray, 6 pcs.
bandeja térmica, set de 6
plateau thermique, set de 6



6 teiliges Set:

- 1 Schale
- 1 Edelstahl-Tablett
- 2 Kühllakkus
- 1 Frischhaltehaube
- 1 Transport- und Tragegurt aus Silikon

6 pcs.:

- 1 plastic tray
- 1 stainless tray
- 2 coolers + 1 cover
- 1 silicone transport and carrying strap

set de 6:

- 1 bandeja de plástico
- 1 bandeja de acero inoxidable
- 2 acumuladores de frío
- 1 campana
- 1 correa de silicona para cierre y transporte

set de 6:

- 1 plateau plastique
- 1 plateau en acier inox
- 2 accumulateurs de froid
- 1 cloche transparente
- 1 sangle en silicone pour fermeture et transport

NEU
inkl.
Transport- und
Tragegurt!

	cm	↑ cm	Farbe / Colour
09094	35	15	
09093	35	15	



inkl. 2x Kühl-Akkus
incl. 2x cooler keeps

BEVERAGE DISPENSER



7 ltr.

Getränkespender „OLD FASHIONED“

beverage dispenser
dispensador de bebidas
distributeur de boissons



dicke, stabile Wände, weite Öffnung für große Zutaten, Gestell schwarz
thick, stable walls, a wide opening for large ingredients, black stand
tiene paredes gruesas y estables, amplia abertura para ingredientes grandes, soporte negro
des murs épais et stables, large ouverture pour de grands ingrédients, support noir

	Ø cm	↑ cm	ltr.	
10409	27	50,5	7	inkl. Gestell / incl. stand

Ersatz-Gestell zu Getränkenspender / stand for beverage dispenser / soporte de recambio para el dispensador de bebidas / support de remplacement pour le distributeur de boissons

	Ø cm	↑ cm	
10410	27	31,5	

Ersatz-Glas zu Getränkenspender ohne Zapfhahn / replacement glass for beverage dispenser without tap / cristal de recambio para el dispensador de bebidas sin grifo / vitre de rechange pour le distributeur de boissons sans robinet

	Ø cm	↑ cm	ltr.
10411	19	36,5	7

Ersatz-Zapfhahn zu Getränkenspender / replacement tap for beverage dispenser

10718



7 ltr.

Getränkespender „ASIA“

beverage dispenser
dispensador de bebidas
distributeur de boissons



dicke, stabile Wände, weite Öffnung für große Zutaten, Fuß und Deckel aus Holz
thick, stable walls, a wide opening for large ingredients, wooden stand and lid
tiene paredes gruesas y estables, amplia abertura para ingredientes grandes, soporte y tapa de madera
des murs épais et stables, large ouverture pour de grands ingrédients, support et couvercle en bois

	Ø cm	↑ cm	ltr.	
10403	24,5	45,5	7	inkl. Gestell / incl. stand

Ersatz-Fuß zu Getränkenspender mit Anti-Rutsch-Füßchen / base to beverage dispenser with non slip feet / soporte de recambio para el dispensador de bebidas con pies antideslizantes / support de remplacement pour le distributeur de boissons avec pieds antidérapants

	Ø cm	↑ cm	
10404	24,5	15	

Ersatz-Deckel zu Getränkenspender / replacement lid for beverage dispenser / tapa de recambio para el dispensador de bebidas / couvercle de rechange pour le distributeur de boissons

	Ø cm	↑ cm	
10405	14,0	5	

BEVERAGE DISPENSER



Getränkespender „ELEMENT“

beverage dispenser
dispensador de bebidas
distributeur de boissons



dicke, stabile Wände, weite Öffnung für große Zutaten, Fuß und Deckel aus Beton
thick, stable walls, a wide opening for large ingredients, stand and lid made of concrete
tiene paredes gruesas y estables, amplia abertura para ingredientes grandes, soporte y tapa de hormigón
des murs épais et stables, large ouverture pour de grands ingrédients, support et couvercle en béton

	Ø cm	↑ cm	ltr.	
10400	22	45	7	inkl. Gestell / incl. stand



Getränkespender

beverage dispenser
dispensador de bebidas
distributeur de boissons



dicke, stabile Wände, weite Öffnung für große Zutaten
thick, stable walls, a wide opening for large ingredients
tiene paredes gruesas y estables, amplia abertura para ingredientes grandes
des murs épais et stables, large ouverture pour de grands ingrédients

	Ø cm	↑ cm	ltr.
10855	20	30,5	7



Tropfenschale, 2-teilig

drip tray, 2 pcs.
aros anti-goteo, set de 2
anneaux coupe-gouttes, set de 2



	Ø cm	↑ cm	Farbe / Colour
10851	9,5	1,5	White
10853	9,5	1,5	Black



Eiswasserröhre

ice cube cooling tube
tubo enfriador para cubitos
tube pour glaçons



	Ø cm	↑ cm	passend für Getränkenspender / fits to drink dispenser
10849	11	24	10400, 10403, 10855



Präsentationsmöglichkeit
presentation example

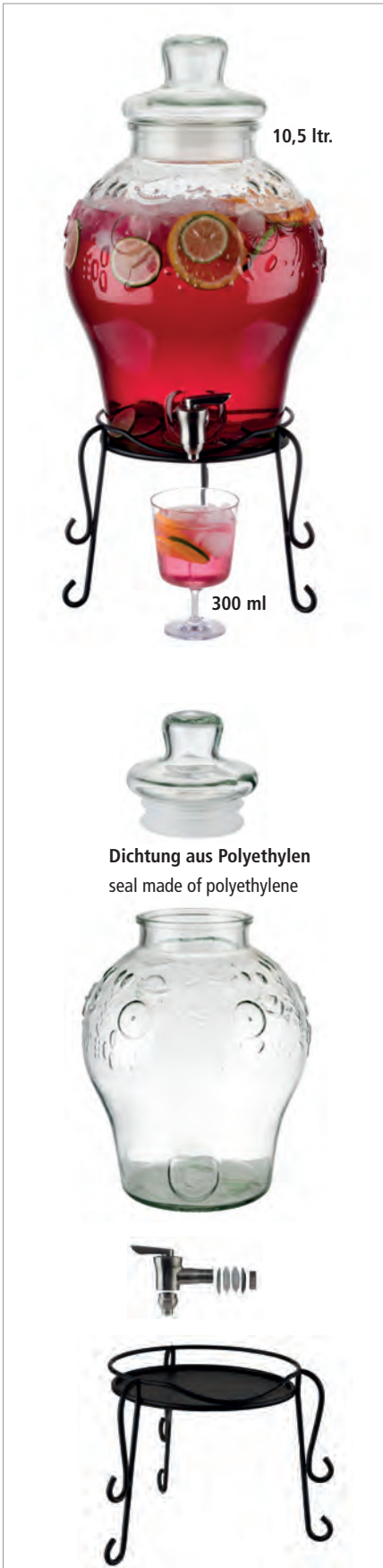

10,5 ltr.

300 ml

Dichtung aus Polyethylen
seal made of polyethylen

Getränkespender „FRUITS“

beverage dispenser
dispensador de bebidas
distributeur de boissons



dicke, stabile Wände, weite Öffnung für große Zutaten, Gestell schwarz
thick, stable walls, a wide opening for large ingredients, black stand
tiene paredes gruesas y estables, amplia abertura para ingredientes grandes, soporte negro
des murs épais et stables, large ouverture pour de grands ingrédients, support noir

	Ø cm	↑ cm	ltr.	
10415	25	58	10,5	inkl. Gestell / incl. stand

Trinkglas „BEACH“

drinking glass / vaso / verre



	Ø cm	↑ cm	ltr.	VE
10505	8,5	13,5	0,3	48

Ersatzteile Getränkspender „FRUITS“

spare parts beverage dispenser
recambios dispensador de bebidas
pièces distributeur de boissons

Ersatz-Deckel zu Getränkspender „FRUITS“
replacement glass for beverage dispenser / cristal de recambio
para el dispensador de bebidas / vitre de rechange pour le
distributeur de boissons



	Ø cm	↑ cm
10418	14	12

Ersatz-Glas zu Getränkspender „FRUITS“ inkl. Deckel, ohne Zapfhahn

replacement glass for beverage dispenser without tap
cristal de recambio para el dispensador de bebidas sin grifo
vitre de rechange pour le distributeur de boissons sans robinet

	Ø cm	↑ cm	ltr.
10417	25	42	10,5

Ersatz-Zapfhahn zu Getränkspender
replacement tap for beverage dispenser
grifo de recambio para el dispensador de bebidas
robinet de rechange pour le distributeur de boissons



10718

Ersatz-Gestell zu Getränkspender
stand for beverage dispenser
soporte de recambio para el dispensador de bebidas
support de remplacement pour le distributeur de boissons



	Ø cm	↑ cm
10416	26	19

Trinkglas „OLD FASHIONED“

drinking cup
vaso
gobelet



	Ø cm	↑ cm	ltr.	VE
10520	8	12,5	0,3	6

BEVERAGE DISPENSER



4,5 ltr.

300 ml

Glas inkl.
Zapfhahn

Getränkespender „FRESH WHITE“

beverage dispenser
dispensador de bebidas
distributeur de boissons

Behälter mit Edelstahlzapfhahn und Holzdeckel, stabiles Glas,
inkl. weißem Holzstandfuß und Kork-Untersetzer

container with stainless steel tap and wooden cover, solid glass,
incl. white wooden base and cork coaster

recipiente con grifo de acero inoxidable y tapa de madera, cristal sólido,
incl. pie de madera blanca y posavasos de corcho

réceptif avec robinet en acier inox et couvercle en bois, verre robuste,
incl. pied en bois blanc et soucoupes de liège

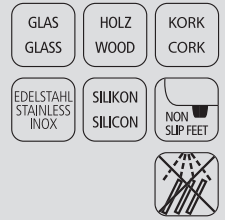

	cm	↑ cm	ltr.	
10420	23 x 23	56,5	4,5	inkl. Gestell / incl. stand

Trinkbecher „CRYSTAL“
drinking cup / vaso / gobelet



	Ø cm	↑ cm	ltr.	VE
10501	8	12,5	0,3	48

Ersatzteile Getränkspender „FRESH WHITE“

spare parts beverage dispenser
recambios dispensador de bebidas
pièces distributeur de boissons

Ersatz-Deckel zu Getränkspender „FRESH WHITE“

replacement lid for beverage dispenser
tapa de recambio para el dispensador de bebidas
couvercle de rechange pour le distributeur de boissons



	Ø cm	↑ cm	Farbe / Colour
10423	11,5	1,5	_____

Ersatz-Glas zu Getränkspender „FRESH WHITE“, inkl. Zapfhahn

replacement glass for beverage dispenser with tap
cristal de recambio para el dispensador de bebidas con grifo
vitre de rechange pour le distributeur de boissons avec robinet



	Ø cm	↑ cm	ltr.
10422	15,5	42,0	4,5

Ersatz-Untersetzer aus Kork zu Getränkspender „FRESH WHITE“

replacement cork coaster for beverage dispenser
posavasos de corcho de recambio para el dispensador de bebidas
soucoupes de liège de rechange pour le distributeur de boissons



	Ø cm	↑ cm
10424	16,5	1,5

Ersatz-Gestell zu Getränkspender „FRESH WHITE“

stand for beverage dispenser
soporte de recambio para el dispensador de bebidas
support de remplacement pour le distributeur de boissons



	cm	↑ cm	Farbe / Colour
10421	23 x 23	14	_____



4,5 ltr.

300 ml



4,5 ltr.

Glas inkl. Zapfhahn



Getränkespender „FRESH WOOD“

beverage dispenser
dispensador de bebidas
distributeur de boissons

Behälter mit Edelstahlzapfhahn und Korkdeckel, stabiles Glas,
inkl. Holzstandfuß und Kork-Untersetzer

container with stainless steel tap and cork cover, solid glas,
incl. wooden base and cork coaster

recipiente con grifo de acero inoxidable y tapa de corcho, cristal sólido,
incl. pie de madera y posavasos de corcho

réceptif avec robinet en acier inox et couvercle de liège, verre robuste,
incl. pied en bois et soucoupes de liège

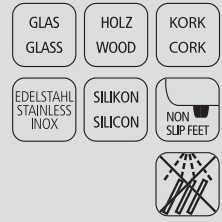

	cm	↑ cm	ltr.	
10430	23 x 23	56,5	4,5	inkl. Gestell / incl. stand

Trinkbecher „CRYSTAL“
drinking cup / vaso / gobelet



	Ø cm	↑ cm	ltr.	VE
10501	8	12,5	0,3	48

Tropfenschale
drip tray
aro anti-goteo
anneau coupe-gouttes



	Ø cm	↑ cm	Farbe / Colour
10851	9,5	1,5	

Ersatzteile Getränkspender „FRESH WOOD“

spare parts beverage dispenser
recambios dispensador de bebidas
pièces distributeur de boissons

Ersatz-Deckel zu Getränkspender „FRESH WOOD“
replacement lid for beverage dispenser
tapa de recambio para el dispensador de bebidas
couvercle de rechange pour le distributeur de boissons



	Ø cm	↑ cm	Farbe / Colour
10428	11,5	1,5	

Ersatz-Glas zu Getränkspender „FRESH WOOD“, inkl. Zapfhahn
replacement glass for beverage dispenser with tap
cristal de recambio para el dispensador de bebidas con grifo
vitre de rechange pour le distributeur de boissons avec robinet



	Ø cm	↑ cm	ltr.
10422	15,5	42,0	4,5

Ersatz-Untersetzer aus Kork zu Getränkspender „FRESH WOOD“
replacement cork coaster for beverage dispenser
posavasos de corcho de recambio para el dispensador de bebidas
soucoupes de liège de rechange pour le distributeur de boissons



	Ø cm	↑ cm
10424	16,5	1,5

Ersatz-Gestell zu Getränkspender „FRESH WOOD“
stand for beverage dispenser
soporte de recambio para el dispensador de bebidas
support de remplacement pour le distributeur de boissons



	cm	↑ cm	Farbe / Colour
10426	23 x 23	14	

BEVERAGE DISPENSER



Getränkespender „NORDIC WHITE“

beverage dispenser
dispensador de bebidas
distributeur de boissons

Behälter mit Edelstahlzapfhahn und Holzdeckel, stabiles Glas,
inkl. weißem Holzstandfuß und Kork-Untersetzer

container with stainless steel tap and wooden cover, solid glass,
incl. white wooden base and cork coaster

recipiente con grifo de acero inoxidable y tapa de madera, cristal sólido,
incl. pie de madera blanca y posavasos de corcho

réceptif avec robinet en acier inox et couvercle en bois, verre robuste,
incl. pied en bois blanc et soucoupes de liège

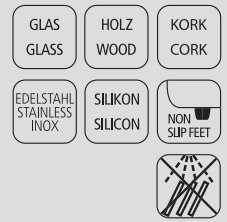

	cm	↑ cm	ltr.	
10425	23 x 23	60,5	7,5	inkl. Gestell / incl. stand

Trinkbecher „CRYSTAL“ drinking cup / vaso / gobelet



	Ø cm	↑ cm	ltr.	VE
10501	8	12,5	0,3	48

Tropfenschale drip tray aro anti-goteo anneau coupe-gouttes



	Ø cm	↑ cm	Farbe / Colour
10851	9,5	1,5	

Ersatzteile Getränkspender „NORDIC WHITE“

spare parts beverage dispenser
recambios dispensador de bebidas
pièces distributeur de boissons

Ersatz-Deckel zu Getränkspender „NORDIC WHITE“

replacement lid for beverage dispenser
tapa de recambio para el dispensador de bebidas
couvercle de rechange pour le distributeur de boissons avec robinet



	Ø cm	↑ cm	Farbe / Colour
10423	11,5	1,5	

Ersatz-Glas zu Getränkspender „NORDIC WHITE“, inkl. Zapfhahn

replacement glass for beverage dispenser with tap
cristal de recambio para el dispensador de bebidas con grifo
vitre de rechange pour le distributeur de boissons avec robinet



	Ø cm	↑ cm	ltr.
10427	17	46	7,5

Ersatz-Untersetzer aus Kork zu Getränkspender „NORDIC WHITE“

replacement cork coaster for beverage dispenser
posavasos de corcho de recambio para el dispensador de bebidas
soucoupes de liège de rechange pour le distributeur de boissons



	Ø cm	↑ cm
10424	16,5	1,5

Ersatz-Gestell zu Getränkspender „NORDIC WHITE“

stand for beverage dispenser
soporte de recambio para el dispensador de bebidas
support de remplacement pour le distributeur de boissons



	cm	↑ cm	Farbe / Colour
10421	23 x 23	14	



7,5 ltr.

300 ml



Glas inkl. Zapfhahn



Getränkespender „NORDIC WOOD“

beverage dispenser
dispensador de bebidas
distributeur de boissons

Behälter mit Edelstahlzapfhahn und Korkdeckel, stabiles Glas,
inkl. Holzstandfuß und Kork-Untersetzer

container with stainless steel tap and cork cover, solid glas,
incl. wooden base and cork coaster

recipiente con grifo de acero inoxidable y tapa de corcho, cristal sólido,
incl. pie de madera y posavasos de corcho

réceptif avec robinet en acier inox et couvercle de liège, verre robuste,
incl. pied en bois et soucoupes de liège

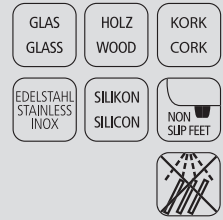

	cm	↑ cm	ltr.	
10435	23 x 23	60,5	7,5	inkl. Gestell / incl. stand

Trinkbecher „CRYSTAL“
drinking cup / vaso / gobelet



	Ø cm	↑ cm	ltr.	VE
10501	8	12,5	0,3	48

Ersatzteile Getränkespender „NORDIC WOOD“

parts beverage dispenser
recambios dispensador de bebidas
pièces distributeur de boissons

Ersatz-Deckel zu Getränkespender
replacement lid for beverage dispenser
tapa de recambio para el dispensador de bebidas
couvercle de rechange pour le distributeur de boissons



	Ø cm	↑ cm
10428	11,5	1,5

Ersatz-Glas zu Getränkespender „NORDIC WOOD“, inkl. Zapfhahn
replacement glass for beverage dispenser with tap
cristal de recambio para el dispensador de bebidas con grifo
vitre de rechange pour le distributeur de boissons avec robinet



	Ø cm	↑ cm	ltr.
10427	17	46	7,5

Ersatz-Untersetzer aus Kork zu Getränkespender „NORDIC WOOD“
replacement cork coaster for beverage dispenser
posavasos de corcho de recambio para el dispensador de bebidas
soucoupes de liège de rechange pour le distributeur de boissons



	Ø cm	↑ cm
10424	16,5	1,5

Ersatz-Gestell zu Getränkespender „NORDIC WOOD“
stand for beverage dispenser
soporte de recambio para el dispensador de bebidas
support de remplacement pour le distributeur de boissons



	cm	↑ cm	Farbe / Colour
10426	23 x 23	14	

BEVERAGE DISPENSER



Saftdispenser „TOP FRESH“

juice dispenser
dispensador de zumo
distributeur à jus de fruit



hochglanzpoliert, Kühlung durch 2 Kühllakkus von oben und unten
mirror polished finish, cooling with 2 cooling elements from the top and base

base inox brillante, con 2 acum. de frio, 1 arriba y 1 en la base

base inox poli brillant, 2 plaques de froid (1 dans le couvercle, 1 dans le socle)

	cm	↑ cm	ltr.
10800	21 x 32	43	4
10700	23 x 35	52	6



Saftdispenser DUO „TOP FRESH“

juice dispenser
dispensador de zumo
distributeur à jus de fruit



hochglanzpoliert, Kühlung durch 2 Kühllakkus von oben und unten

mirror polished finish, cooling with 2 cooling elements from the top and base

base inox brillante, con 2 acum. de frio, 1 arriba y 1 en la base

base inox poli brillant, 2 plaques de froid (1 dans le couvercle, 1 dans le socle)

	cm	↑ cm	ltr.
10720	42 x 32	52	2 x 6



Saft- und Milchdispenser MIX „TOP FRESH“

juice and milk dispenser
dispensador mixto zumo y leche
distributeur mixte à lait et à jus de fruit



6 Liter Saftbehälter, 5 Liter Milchkanne, Kühlung durch Kühllakkus von oben und unten

6 liters juice container, 5 liters milkcan, cooling with cooling elements from the top and base

recipiente de zumo 6 litros, recipiente de leche 5 litros, 2 enfriadores
réipient à jus 6 l, réipient à lait 5 l, plaques de froid

	cm	↑ cm	ltr.
10760	42 x 35	52	6 + 5



Iso-Dispenser

insulated dispenser
dispensador isotérmico
distributeur de boisson isothermique



für heiße und kalte Getränke

for hot and cold drinks

para bebidas frías y calientes

pour boissons chaudes ou froides

	∅ cm	↑ cm	ltr.
10788	24	42	9,5

Hahn / tap / grifo / robinet

10789



1) Deckel / cover / tapa / couvercle
für ltr. / for ltr. / para ltr. / pour ltr.

10701 6
10801 4

2) Kühlakku / cooler / acumulador de frío / accumulateur de froid
für ltr. / for ltr. / para ltr. / pour ltr.

10777 4 / 6

3) Behälter inkl. Zapfhahn / container incl. tap
recipiente con grifo / récipient avec robinet
für ltr. / for ltr. / para ltr. / pour ltr.

10703 6
10803 4

3) Behälter ohne Zapfhahn / container without tap
recipiente sin grifo / récipient sans robinet
für ltr. / for ltr. / para ltr. / pour ltr.

10704 6
10804 4

4) Non-Drip Hahn / non-drip tap / grifo anti-goteo / robinet anti-goutte
für ltr. / for ltr. / para ltr. / pour ltr.

10707 6
10807 4

5) Dichtungsring / sealing ring / arandela / rondelle
für ltr. / for ltr. / para ltr. / pour ltr.

10608 4 / 6

6) Einsatz / insert / aro inox / cercle inox
für ltr. / for ltr. / para ltr. / pour ltr.

10708 6
10808 4

7) Standfuß 18/10 Edelstahl / column 18/10 stainless steel
base inox 18/10 / socle inox 18/10
für ltr. / for ltr. / para ltr. / pour ltr.

10709 6
10809 4

8) Tropfgitter 18/10 Edelstahl / drip lattice 18/10 stainless steel
rejilla recoge gotas 18/10 / grille ramasse-gouttes 18/10
für ltr. / for ltr. / para ltr. / pour ltr.

10712 6
10713 DUO
10812 4

9) Bodenplatte 18/10 Edelstahl / footing 18/10 stainless steel
base de 18/10 acero / socle inox 18/10
für ltr. / for ltr. / para ltr. / pour ltr.

10710 6
10711 DUO / 6 + 6
10814 4

1x Dichtung, 2x Dichtungsring (transparent), 1x Dichtungsring (s / w)
1x seal, 2x sealing ring (transparent), 1x sealing ring (b / w)
Zubehör / Reinigungsset - für die regelmäßige Reinigung

10714 für Zapfhahn 10707
10715 für Zapfhahn 10807
10716 für Zapfhahn 10907
10717 für Zapfhahn 10867



BEVERAGE DISPENSER



Der Adapter passt auf alle Dispenser der Serien TOP FRESH, BRIDGE und SUNDAY und kann ganz einfach installiert werden

The adapter fits all dispensers of the series TOP FRESH, BRIDGE and SUNDAY and can be installed very easily.

El adaptador se adapta a todos los dispensadores de las series TOP FRESH, BRIDGE y SUNDAY y puede ser instalado fácilmente.

L'adaptateur s'adapte à tous les distributeurs des séries TOP FRESH, BRIDGE et SUNDAY et peut être installé très facilement.



Adapter „TOP FRESH“

adapter
adaptador
adaptateur



handkontaktloser Adapter, einfach zu installieren

adapter touchless for tap, easy to install

adaptador sin contacto para grifo

adaptateur sans contact manuel, facile à installer

	cm	↑ cm
10802	12 x 4,5	5,5



Einfach den Adapter an der dafür vorgesehenen Öffnung auf den Hebel des Zapfhahns stecken.

Simply plug the adapter onto the lever of the tap at the opening provided.

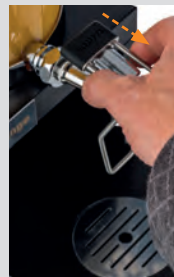

Anschließend den Adapter nach unten festziehen. Durch das Nach-Vorne-Drücken des unteren Edelstahlbügels mit Hilfe des Glases, wird der Hebel des Zapfhahns betätigt und das Getränk fließt völlig handkontaktlos in das Glas.

Then tighten the adapter downwards. By pushing the lower stainless steel bracket forward with the help of the glass, the lever of the tap is activated and the drink flows into the glass completely without hand contact.

passend für / suitable for:



Saftdispenser „TOP FRESH“
Katalog Seite 46
juice dispenser,
catalog page 46



Milchkanne „TOP FRESH“
Katalog Seite 51
milk dispenser,
catalog page 51



Saftdispenser „BRIDGE“
Katalog Seite 20
juice dispenser,
catalog page 20



Saftdispenser „SUNDAY“

juice dispenser
dispensador de zumo
distributeur à jus de fruit



matt poliert, Kühlung durch 2 Kühllakkus von oben und unten
satin polished finish, cooling with 2 cooling elements from the top and base
acabado pulido brillante, 2 acum. de frío (1 en la base y 1 en la tapa)
inox mat, 2 accus. de froid (1 socle et 1 couvercle)

	cm	↑ cm	ltr.
10860	21 x 35	48	6



Saft- / Milchdispenser „SUNDAY“

juice and milk dispenser
dispensador mixto zumo y leche
distributeur mixte à lait et à jus de fruit



matt poliert, Behälter gefrostet, Kühlung durch 2 Kühllakkus von oben und unten
satin polished finish, canister frosted look, cooling with 2 cooling elements from the top and base
inox acabado pulido mate, 1 recipiente policarbonato aspecto glaseado, 2 enfriadores en la base y en la tapa
inox mat, récipient polycarbonate opaque, 2 accus. de froid dans le socle et dans le couvercle

	cm	↑ cm	ltr.
10865	21 x 35	48	6



Saftdispenser DUO „SUNDAY“

juice dispenser
dispensador de zumo doble
distributeur à jus de fruit double



matt poliert, Kühlung durch 4 Kühllakkus von oben und unten
satin polished finish, cooling with 4 cooling elements from the top and base
inox acabado pulido mate, 4 enfriadores en la base y en la tapa
inox mat, 4 accus. de froid (socle et couvercle)

	cm	↑ cm	ltr.
10862	35 x 45	48	2 x 6



Saft- / Milchdispenser DUO „SUNDAY“

juice and milk dispenser
dispensador mixto zumo y leche
distributeur mixte à lait et à jus de fruit



matt poliert, 1 Behälter gefrostet, 1 Behälter transparent, 4 Kühllakkus von oben und unten
satin polished finish, 1 canister frosted look, 1 canister transparent, cooling with 4 cooling elements from the top and base
inox mate, 1 recipiente opaco, 1 recipiente transparente, 4 enfriadores (base y tapa)
inox mat, 1 récipient opaque, 1 récipient transparent, 4 accus. de froid (socle et couvercle)

	cm	↑ cm	ltr.
10864	35 x 45	48	2 x 6

Saftbehälter transparent, ohne Zapfhahn / juice canister transparent, without tap / contenedor transparente sin grifo / récipient cylindrique sans le robinet

	Ø cm	↑ cm	ltr.
10806	22	26	6

Milchbehälter, gefrostet, ohne Zapfhahn / milk canister, frosted look, without tap / contenedor de leche, efecto glaseado, sin grifo / récipient cylindrique mat (idéal pour le lait) sans le robinet

	Ø cm	↑ cm	ltr.
10805	22	26	6

Hahn / tap / grifo / robinet

10867			
-------	--	--	--

BEVERAGE DISPENSER



NEW

inkl. Crushediceröhre
incl. crushed ice tube

5 ltr.

Saftdispenser „TOWER“

juice dispenser
dispensador de zumo
distributeur à jus de fruit

aus Edelstahl, inklusive Crushediceröhre
made of stainless steel, inclusive crushed ice tube
de acero inoxidable con tubo para hielo picado
en acier inox avec tube de glace pilée



	cm	↑ cm	ltr.
10440	35 x 23	75	5



Edelstahl Zapfhahn
stainless steel tap



NEW



Massives Buchenholz gebeizt
solid beech wood, stained

Milchdispenser „BRIDGE“

milk dispenser
dispensador de leche
distributeur à lait

Edelstahl Dispenser mit 1 Kühllakku im Standfuß inkl. touchless adapter
stainless steel dispenser with 1 cooling element in stand incl. touchless adapter
dispensador de acero inoxidable con 1 acumulador de frío en la base y con adaptador sin contacto para grifo
distributeur en acier inox avec 1 accumulateur de froid sand le socle et avec adaptateur sans contact manuel



	cm	↑ cm	ltr.	Farbe / Colour
10837	31 x 20	39	3	■
10839	39 x 22	45	5	■



NEW



Massives Ahornholz
solid maple wood

Milchdispenser „BRIDGE“

milk dispenser
dispensador de leche
distributeur à lait

Edelstahl Dispenser mit 1 Kühllakku im Standfuß inkl. touchless adapter
stainless steel dispenser with 1 cooling element in stand incl. touchless adapter
dispensador de acero inoxidable con 1 acumulador de frío en la base y con adaptador sin contacto para grifo
distributeur en acier inox avec 1 accumulateur de froid sand le socle et avec adaptateur sans contact manuel



	cm	↑ cm	ltr.	Farbe / Colour
10836	31 x 20	39	3	■
10838	39 x 22	45	5	■



Saftdispenser „BRIDGE“

juice dispenser
dispensador de zumo
distributeur à jus



Kühlung durch 2 Kühllakus von oben und unten
cooling with 2 cooling elements from the top and base
2 acum. de frío 1 en la base y 1 en la tapa
2 plaques de froid 1 dans le couvercle, 1 dans le socle

	cm	↑ cm	ltr.	Farbe / Colour
10872	31,0 x 20	42	4	■
10873	35,5 x 22	50	6	■



inkl. 3 Magnetschilder: ORANGE, APPLE, GRAPEFRUIT
including 3 magnetic signs: ORANGE, APPLE, GRAPEFRUIT



Saftdispenser „BRIDGE“

juice dispenser
dispensador de zumo
distributeur à jus



Kühlung durch 2 Kühllakus von oben und unten
cooling with 2 cooling elements from the top and base
2 acum. de frío 1 en la base y 1 en la tapa
2 plaques de froid 1 dans le couvercle, 1 dans le socle

	cm	↑ cm	ltr.	Farbe / Colour
10870	31,0 x 20	42	4	■
10871	35,5 x 22	50	6	■

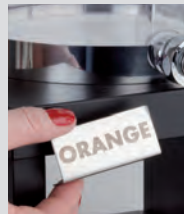

inkl. 3 Magnetschilder: ORANGE, APPLE, GRAPEFRUIT
including 3 magnetic signs: ORANGE, APPLE, GRAPEFRUIT



Milchkanne „TOP FRESH“

milk dispenser
dispensador de leche
distributeur à lait



hochglanzpoliert, 1 Kühllaku im Standfuß, „original Milchkanne mit Henkel“
mirror polished finish, 1 cooler in base, original milkcan
inox brillante, 1 acumulador de frío en la base, recipiente „lechera“
inox poli brillant, 1 accum. de froid dans le socle, design „pot à lait“

	cm	↑ cm	ltr.
10830	21 x 32	39	3
10750	23 x 35	45	5

Milchkanne ohne Zapfhahn / milkcan without tapjarra de leche sin grifo / récipient à lait sans robinet

	Ø cm	↑ cm	ltr.
10833	16	22	3
10663	22	26	5

BEVERAGE DISPENSER



Milchkanne „TOP FRESH“

milk dispenser
dispensador de leche
distributeur à lait



inkl. Porzellanschild zum Beschriften, 1 Kühllakku im Fuß
incl. porcelain sign, 1 cooler in base
incluye cartelito en porcelana, 1 enfriador en la base
indicateur en porcelaine inclus, plaque de froid dans le socle

	cm	↑ cm	ltr.
10850	31 x 21	42	4



Milchkanne „TOP FRESH“

milk dispenser
dispensador de leche
distributeur à lait



Buchen-Holz versiegelt, inkl. Porzellanschild zum Beschriften, 1 Kühllakku im Fuß
beech wood, waterproof, incl. porcelain sign, 1 cooler in base
madera de haya, resistente al agua, incluye placa de porcelana, 1 enfriador en la base
socle bois hêtre traité, indicateur en porcelaine inclus, plaque de froid dans le socle

	cm	↑ cm	ltr.
10840	23 x 32,0	42	4
10757	27 x 38,5	45	8

Milchkanne Porzellan, ohne Zapfhahn / milkcan porcelain, without tap / jarra de leche sin grifo / récipient en porcelaine sans robinet

	Ø cm	↑ cm	ltr.
10825	18	25	4
10758	22	26	8

Deckel für 10840, 10850 / cover for 10840, 10850 / tapa para 10840, 10850 / couvercle pour 10840, 10850

10859

Deckel für 10757 / cover for 10757 / tapa para 10757 / couvercle pour 10757

10759

Schild und Kette / shield and chain / placa y cadena / indicateur porcelaine avec chaînette

10756

Zapfhahn / tap / grifo / robinet

10907



Saftdispenser „INOX STAR“

juice dispenser
dispensador de zumo
distributeur à jus de fruit



Edelstahl-Crushed Ice Röhre herausnehmbar

stainless steel crash ice tube
con tubo inox refrigerante extraíble para hielo picado
avec tube inox réfrigérant amovible pour glace pilée

	cm	↑ cm	ltr.
10795	36 x 26	55	8



Saftdispenser DUO „INOX STAR“

juice dispenser
dispensador de zumo
distributeur à jus de fruit



Edelstahl-Crushed Ice Röhre herausnehmbar

stainless steel crash ice tube
con tubo inox refrigerante extraíble para hielo picado
avec tubes inox réfrigérants amovibles pour glace pilée

	cm	↑ cm	ltr.
10810	36 x 52	55	2 x 8

Behälter / container / recipiente / récipient

	Ø cm	ltr.
10796	22	8



Kaffeedispenser „HAPPY HOUR“

coffee dispenser
dispensador de café
distributeur de café



hochglanzpoliert, für warme Getränke, stabil und standfest, inkl. 1 Brennpastenbehälter
mirror polished finish, for warm drinks, solid and stable, incl. 1 burner holder
acabado pulido brillante para bebidas calientes, sólido y estable, incluye un calentador
brillant, pour boissons chaudes, avec 1 brûleur, robuste et stable

	cm	↑ cm	ltr.
11672	31 x 33,5	54,5	10,5

Hahn / tap / grifo / robinet

11671			
-------	--	--	--

Elektro-Heizelement / heating unit / resistencia / résistance

	cm	↑ cm
12287	21 x 20	6



Pump-Isolierkanne „BUDGET“

air pot
jarra termo
bouteille isotherme



doppelwandig, Tragegriff, Dreh-Pumpknopf zur leichten Bedienung (close/open), Pumpmechanismus ist leicht zu entnehmen und zu reinigen, aufgeklappt passt die Kanne unter die gängigen Kaffeeautomaten, für heiße und kalte Getränke

double-walled, carrying handle, rotatable Push-Button for easy use (close/open), pump mechanism is easily removable for cleaning, with flipped-back lid, the air pot fits under a wide range of coffee makers, for hot and cold beverages

doble pared, con asa al lateral, tapa girable y a presión para uso fácil (close/open), el mecanismo a presión es fácil de retirar para limpiar, con la tapa abierta la jarra se puede usar con casi todas las cafeteras corrientes, para bebidas frías y calientes

double paroi, avec poignée, couvercle à visser et a pression pour facile usage (close/open), le mécanisme a pression est facile à retirer pour le nettoyage, avec la couvercle ouverte la bouteille se peut user avec toutes les machines à café courantes, pour boissons chaudes ou froides

	Ø cm	↑ cm	ltr.	Anzahl der Tassen
10915	13,5	32,5	2,2	17



Pump-Isolierkanne „PREMIUM“

air pot
jarra termo
bouteille isotherme



doppelwandig, Tragegriff, drehbarer Fuß, Pumpmechanismus und Füllstandsanzeige sind leicht zu reinigen mit 4 unterschiedlichen Inhaltsbeschriftungen für den Pumphebel (coffee, tea, hot water, decaf), aufgeklappt passt die Kanne unter die gängigen Kaffeeautomaten, für heiße und kalte Getränke

double-walled, carrying handle, pivotable feet, pump mechanism and fill level indicator is easily removable for cleaning, includes 4 different beverage signs (coffee, tea, hot water, decaf), with flipped-back lid, the air pot fits under a wide range of coffee makers, for hot and cold beverages

doble pared, con asa al lateral, pié girable, el mecanismo a presión y el indicador óptico del nivel son fácil de limpiar, con 4 etiquetas diferentes para la palanca (coffee, tea, hot water, decaf), con la tapa abierta la jarra se puede usar con casi todas las cafeteras corrientes, para bebidas frías y calientes

double paroi, avec poignée, pied pivotant, le mécanisme a pression et l'indicateur de niveau sont facile à retirer pour le nettoyage, avec 4 étiquettes différents pour la pompe (coffee, tea, hot water, decaf), avec la couvercle ouverte la bouteille se peut user avec toutes les machines à café courantes, pour boissons chaudes ou froides

	Ø cm	↑ cm	ltr.	Anzahl der Tassen
10916	15	37	3	24

Tropfenfänger für Pump-Isolierkanne / drip tray for air pot / recoge gotas para jarra termo / ramasse-gouttes pour bouteilles isotherme

	cm	↑ cm
10917	24 x 18,5	4



Isolierkanne „ECONOMY“

vacuum jug
jarra termo
bouteille isotherme



robuste Umhüllung mit Polypropylen-Kunststoff, Stabilglaseinsatz, Drehverschluss mit Drucktasten-Bedienung für heiße und kalte Getränke, 8 Tassen

double-walled with glass liner, screw cap with easy push-button pouring system, for hot and cold beverages, 8 cups

exterior de plástico polipropileno, interior aislante de vidrio, con tapa a rosca con cierre dosificador para bebidas frías y calientes, 8 tazas

extérieur en plastique polypropylène, intérieur avec plaque de verre, couvercle à visser, pour boissons chaudes ou froides, 8 tasses

	Ø cm	↑ cm	ltr.	Farbe / Colour
10913	16	20	1	White
10914	16	20	1	Black

**Isolierkanne „CLASSIC“**

vacuum jug
jarra termo
bouteille isotherme



doppelwandig, Einhandautomatik, Drehverschluss, für heiße und kalte Getränke
double-walled, easy push-button pouring system, screw cap, for hot and cold drinks
doble pared, se maneja con 1 mano, con tapa a rosca, para bebidas frías y calientes
double paroi, usage à 1 main, couvercle à visser, pour boissons chaudes ou froides

	Ø cm	↑ cm	ltr.	Anzahl der Tassen
10910	14	19	1,0	8
10911	14	22	1,5	12
10912	14	25	2,0	16

**Isolierkanne „ADVANCED“**

vacuum jug
jarra termo
bouteille isotherme

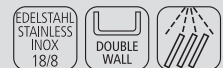

doppelwandig, spülmaschinenfest, Einhandautomatik, aufgeklappt passt die Kanne unter die gängigen Kaffeeautomaten, für heiße und kalte Getränke
double-walled, dishwasher-safe, easy pouring system, with flipped-back lid, the air pot fits under a wide range of coffee makers, for hot and cold beverages
doble pared, resistente al lavavajillas, se maneja con 1 mano, con la tapa abierta la jarra se puede usar con casi todas las cafeteras corrientes, para bebidas frías y calientes
double paroi, résistante au lave-vaisselle, usage à 1 main, avec la couvercle ouverte a bouteille se peut user avec toutes les machines à café courantes, pour boissons chaudes ou froides

	Ø cm	↑ cm	ltr.	Anzahl der Tassen
10921	10,5	13,0	0,3	2,5
10922	10,5	18,0	0,6	5,0
10923	13,0	19,5	1,0	8,0
10924	13,0	23,5	1,5	12,0

CARAFE



Glaskaraffe „OLD FASHIONED“, 2 teilig
 glass carafe, 2 pcs.: 1 bottle, 1 glass
 jarra de vidrio, set de 2: 1 botella, 1 vaso
 carafe en verre, set de 2: 1 bouteille, 1 verre



	Ø cm	↑ cm	ltr.
10690	9,5	31	1,0



1 Flasche 1,0 ltr. / 1 bottle 1,0 ltr.
 1 Glas 0,3 ltr. / 1 glass 0,3 ltr.



Glaskaraffe „OLD FASHIONED“
 glass carafe
 jarra de vidrio
 carafe en verre



Deckel mit Auffangsieb für Kerne oder Eis
 lid with integrated strainer for cores or ice
 tapa con filtro integrado para los huesos o el hielo
 couvercle avec filtre intégré pour les pépins ou la glace

	Ø cm	↑ cm	ltr.
10691	12	26	1,8



Glaskaraffe
 glass carafe
 jarra de vidrio
 carafe en verre



Deckel aus Edelstahl matt poliert
 lid made of matt polished stainless steel
 tapa de acero inoxidable pulido mate
 couvercle en acier inox poli mat

	Ø cm	↑ cm	ltr.
10721	8	25	1,0
10722	8	32	1,2



Ausgießer für tropffreies Ausgießen
 spout for drip-free pouring



Glaskaraffe
 glass carafe
 jarra de vidrio
 carafe en verre



Deckel aus Edelstahl matt poliert, mit integriertem Auffangsieb für Kerne oder Eis
 lid made of matt polished stainless steel, with integrated strainer for cores or ice
 tapa de acero inoxidable pulido mate, con filtro integrado para los huesos o el hielo
 couvercle en acier inox poli mat, avec filtre intégré pour les pépins ou la glace

	Ø cm	↑ cm	ltr.
10792	10	26	1,5



Deckel mit Doppelfunktion
 Lid with double function



Glaskaraffe „LINES“

glass carafe
jarra de vidrio
carafe en verre



	Ø cm	↑ cm	ltr.
10738	8	27	0,9



inkl. Korkdeckel
incl. cork cover



Glaskaraffe „DOTS“

glass carafe
jarra de vidrio
carafe en verre



	Ø cm	↑ cm	ltr.
10739	8	27	0,9



inkl. Korkdeckel
incl. cork cover



Glaskaraffe „WABE“

glass carafe
jarra de vidrio
carafe en verre



	Ø cm	↑ cm	ltr.
10741	8	28	0,8



inkl. Holzkorken mit Silikondichtung
incl. wooden cork with silicone gasket



Glaskaraffe „DIAMOND“

glass carafe
jarra de vidrio
carafe en verre



	Ø cm	↑ cm	ltr.
10742	8	28	0,8



inkl. Holzkorken mit Silikondichtung
incl. wooden cork with silicone gasket

CARAFE



Flasche „STRIPES“
bottle
botella
bouteille



	Ø cm	↑ cm	ltr.
10748	9	28,5	1



Flasche „STRIPES“
bottle
botella
bouteille



	Ø cm	↑ cm	ltr.
10749	9	28,5	1



Kühlkaraffe, 3-teilig „COOL“

cooling carafe, 3 pcs.
jarra fría, set de 3
pichet rafraîchisseur, set 3



1 Glaskaraffe mit Edelstahl Ausgießer, öffnet und schließt selbstständig
+ 1 verchromter Fuß + 1 Kühlakku, werden bis zu 4 Stunden gekühlt

1 glass carafe with stainless steel pourer, open / closing autonomous
+ 1 chrome plated base + 1 cooling pack, up to 4 hours cooled beverages

1 botella de vidrio con vertedor inox y silicona, con autocierre
+ 1 base cromada + 1 placa de frío que mantiene las bebidas frescas hasta unas 4 horas

pichet en verre avec insert verseur inox et silicone, fermeture automatique
+ socle chromé + accumulateur de froid pour maintenir les boissons froides jusqu'à 4 heures

	Ø cm	↑ cm	ltr.
10762	16	27	1,4

Glasflasche / glass carafe / jarra de vidrio / pichet verre

	Ø cm	↑ cm
10761	16	26

Kühlakku rund, schwarz / cooler round, black / cooler / accumulateur de froid, noir

	Ø cm	↑ cm
10752	10,5	2



Edelstahl-Ausgießer
stainless steel pourer



Glaskaraffe

glass carafe
jarra
pichet en verre



der Deckel öffnet sich beim Ausgießen automatisch
cover opens automatically while pouring
la tapa se abre automáticamente durante el vertido
le couvercle s'ouvre seul pendant le service, résistant à la chaleur

	Ø cm	↑ cm	ltr.
10766	9,5	29	1



Glaskaraffe

glass carafe
jarra
pichet verre



Deckel aus Edelstahl matt poliert
stainless steel cover
tapa de acero inoxidable
couvercle inox



Ausgießer für tropffreies ausgießen
spout for drip-free pouring

	Ø cm	↑ cm	ltr.
10764	9,5	27	1,5



Saft- / Wasserkanne

juice / water pitcher
jarra de zumo / agua
pichet à eau ou jus de fruit



mit Eiswasser-Röhre
with water ice tube
con tubo para hielo
avec tube à glaçons plongeant pour réfrigérer

	cm	↑ cm	ltr.
10769	19 x 13	27	2,8



Saftkanne

juice pitcher
jarra de zumo
pichet à jus de fruit



mit Eiswasser-Röhre
with water ice tube
con tubo para hielo
avec tube à glaçons plongeant pour réfrigérer

	Ø cm	↑ cm	ltr.
10770	18	29	3

CARAFE



Saftkanne
juice pitcher
jarra de zumo
pichet à jus de fruit



	Ø cm	↑ cm	ltr.
10775	12	26	2



Saftkanne
juice pitcher
jarra de zumo
pichet à jus de fruit



	Ø cm	↑ cm	ltr.
10776	14	29	2,5



Pitcher
pitcher
jarra
pichet



	Ø cm	↑ cm	ltr.
93105	13	21	1,5



Karaffe / Kanne
bottle
botella
bouteille



Schraubdeckel mit aromadichtem Verschluss
screwed lid, aroma-tight
tapón de rosca, impide la fuga de aromas
bouchon à visser, ne laisse pas passer les arômes

	Ø cm	↑ cm	ltr.	Farbe / Colour
10771	11	30	1,6	
10772	11	30	1,6	
10773	11	30	1,6	
10774	11	30	1,6	



Kühlbox „FROSTY“

bottle cooler
enfriador de botellas
rafraichisseur de bouteilles

mit herausnehmbarem Einsatz für 4 Flaschen

with removable insert for 4 bottles
con inserto extraíble para 4 botellas
avec insert amovible pour 4 bouteilles



Abb. ohne Einsatz
illustration without insert

	cm	↑ cm	ltr.	hole ø cm
93230	27 x 27	15	7,5	11

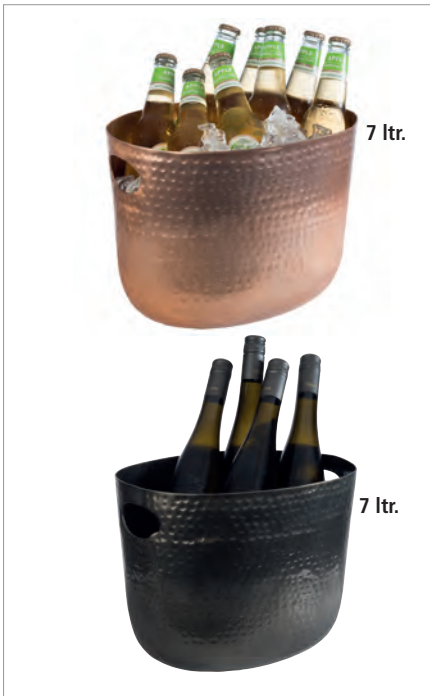

Wein- / Sektkühler

wine / champagne bowl
cubitera para vino y cava
seau à vin ou champagne

gehämmerte Oberfläche mit 2 seitlichen Eingriffen

hammered surface with 2 handles on the side
superficie martillada con 2 asas
surface martelée avec 2 poignées



	cm	↑ cm	ltr.	Farbe / Colour
36111	30 x 23,5	23	7	 copper-look
36112	30 x 23,5	23	7	 gunmetal-look







Getränkewanne „TIN“

beverage tub
barreño botellines
bassine à glace

Metall verzinkt, mit Kunststoffeinsatz

galvanised metal, with plastic insert
metal galvanizado, con inserto de plástico
métal galvanisé, avec insert en plastique



	cm	↑ cm	ltr.	Farbe / Colour
36100	40 x 28	22	11	 copper-look
36101	40 x 28	22	11	 black-metal-look
36095	40 x 28	22	11	 metal-look
36096	50 x 23	23	18	 metal-look



mit Kunststoffeinsatz
with plastic insert
con inserto de plástico
avec insert en plastique



Kreidestift zum
Beschriften
chalk marker for writing
S. 348

CONFERENCE

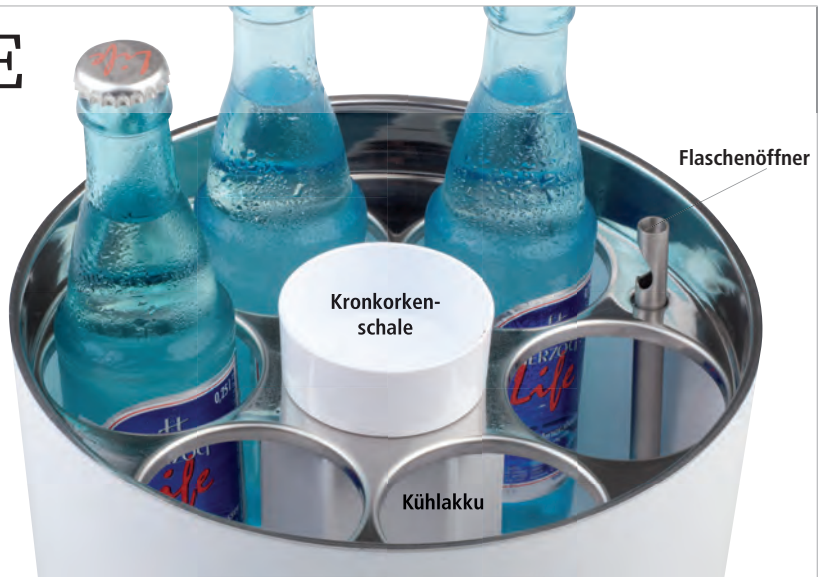

Flaschenkühler „CONFERENCE“

conference bottle cooler
enfriador múltiple
rafraîchisseur



inkl. Kühlakku, Flaschenöffner, Kronkorkenschale,
mit 6 Öffnungen Ø 6,7 cm für 0,25 - 0,5 Liter-Flaschen

incl. bottle cooler, bottle opener, small cap bowl,
with 6 holes Ø 6,7 cm for 0,25 to 0,5 liter bottles

con acumulador de frío, abridor, recuperador de chapas,
6 plazas Ø 6,7 cm, para botellas de 25 a 50 cl

avec accumulateur de froid, décapsuleur, bol récupérateur
de capsules, 6 places Ø 6,7 cm, pour bouteilles de 25 à 50 cl

	Ø cm	↑ cm	Farbe / Colour
00620	23	15	White
00621	23	15	Black



Kühlakku

cooler
acumulador de frío
accumulateur de froid

	Ø cm	→ cm	Farbe / Colour
00616	7,5	11,5	White
00615	7,5	11,5	Black



Flaschenöffner

bottle opener
abridor
décapsuleur



	Ø cm	→ cm
00617	1	13,5



Kronkorkenschale

cap bowl
cuenco para chapas
bol récupérateur de capsules



	Ø cm	↑ cm	Farbe / Colour
00618	6,5	3	White
00619	6,5	3	Black



Teekanne „ASIA“

teapot
tetera
théière



aus Gusseisen, innen emailliert, mit abnehmbarem Deckel, inkl. Teesieb aus Edelstahl, ideal für 2-3 Tassen. Geeignet für alle Herdarten.
made of cast iron, enamelled inside, with removable lid, incl. tea strainer made of stainless steel, ideal for 2-3 cups. Suitable for all types of stoves.
hierro fundido, interior esmaltado, con tapa extraible, incl. colador de té de acero inoxidable, ideal para 2-3 tazas. Apta para todas las placas de cocina.
en fonte, émaillé à l'intérieur, avec couvercle amovible, y compris une passoire à thé en acier inox, idéale pour 2-3 tasses. Convient à tous les types de feux (gaz, vitro ou induction).

	cm	↑ cm	ltr.	Farbe / Colour
10991	19,5 x 18	15	0,8	■
10992	19,5 x 18	15	0,8	■

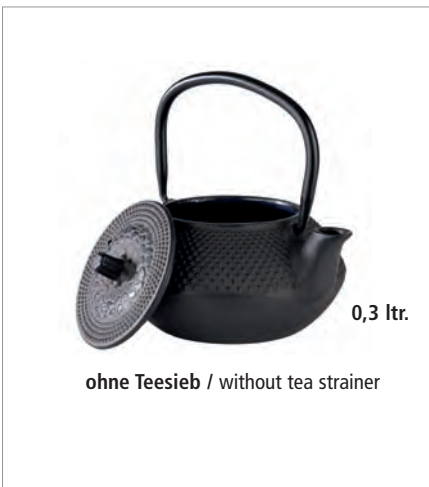

Teekanne „ASIA“

teapot
tetera
théière



aus Gusseisen, innen emailliert, mit abnehmbarem Deckel, ohne Teesieb aus Edelstahl
made of cast iron, enamelled inside, with removable lid, without tea strainer made of stainless steel
hierro fundido, interior esmaltado, con tapa extraible, sin colador de té de acero inoxidable
en fonte, émaillé à l'intérieur, avec couvercle amovible, sans une passoire à thé en acier inox

	cm	↑ cm	ltr.	Farbe / Colour
10990	12,5 x 11	12,5	0,3	■



Stövchen „ASIA“

teapot warmer
calentador de tetera
chauffe-théière



	Ø cm	↑ cm	Farbe / Colour
10994	13	7,5	■

1-flammiges Stövchen aus Gusseisen mit abnehmbarem Deckel (Lieferung ohne Teelicht).
1-flame cast iron warmer with removable lid (delivery without tealight).
calentador de tetera de hierro fundido con 1 quemador con tapa amovible (se entrega sin vela).
chauffe-théière en fonte à 1 brûleur avec couvercle amovible (livraison sans bougie).

Untersetzer aus Gusseisen mit Antirutsch-Füßchen / cast iron coaster with non-slip feet

	Ø cm	↑ cm	Farbe / Colour
10993	13,5	1,5	■



NEW FRESH & EASY



4,5 ltr.

Cerealienspender „FRESH & EASY“

cereal dispenser
dispensador de cereales
distributeur de céréales



Behälter herausnehmbar, „Feierabend-Deckel“ für das aromadichte Lagern, portionieren durch einfaches Drehen

removable canister, special lid to keep the cereals fresh, easy to use, rotate the button to get the muesli

contenedor movable, tapa especial para mantener los cereales frescos, fácil de usar, se gira el pomo para servir los cereales

réipient amovible, couvercle spécial pour conserver les céréales, usage facile en tournant le bouton

	cm	↑ cm	ltr.	Farbe / Colour
11840	22 x 17,5	52	4,5	■

Kunststoffbehälter / canister / contenedor / réipient

	Ø cm	ltr.
11808	24	4,5



2 x 4,5 ltr.

Cerealienspender Duo „FRESH & EASY“

cereal dispenser
dispensador de cereales
distributeur de céréales

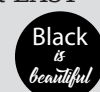

Behälter herausnehmbar, „Feierabend-Deckel“ für das aromadichte Lagern, portionieren durch einfaches Drehen

removable canister, special lid to keep the cereals fresh, easy to use, rotate the button to get the muesli

contenedor movable, tapa especial para mantener los cereales frescos, fácil de usar, se gira el pomo para servir los cereales

réipient amovible, couvercle spécial pour conserver les céréales, usage facile en tournant le bouton

	cm	↑ cm	ltr.	Farbe / Colour
11841	22 x 35	52	2 x 4,5	■

Kunststoffbehälter / canister / contenedor / réipient

	Ø cm	ltr.
11808	24	4,5



4,5 ltr.

Cerealienspender „FRESH & EASY“

cereal dispenser
dispensador de cereales
distributeur de céréales



Behälter herausnehmbar, „Feierabend-Deckel“ für das aromadichte Lagern, portionieren durch einfaches Drehen

removable canister, special lid to keep the cereals fresh, easy to use, rotate the button to get the muesli
contenedor movable, tapa especial para mantener los cereales frescos, fácil de usar, se gira el pomo para servir los cereales
réceptif amovible, couvercle spécial pour conserver les céréales, usage facile en tournant le bouton

	cm	↑ cm	ltr.
11805	22 x 17,5	52	4,5



2 x 4,5 ltr.

Cerealienspender Duo „FRESH & EASY“

cereal dispenser
dispensador de cereales
distributeur de céréales



Behälter herausnehmbar, „Feierabend-Deckel“ für das aromadichte Lagern, portionieren durch einfaches Drehen

removable canister, special lid to keep the cereals fresh, easy to use, rotate the button to get the muesli
contenedor movable, tapa especial para mantener los cereales frescos, fácil de usar, se gira el pomo para servir los cereales
réceptif amovible, couvercle spécial pour conserver les céréales, usage facile en tournant le bouton

	cm	↑ cm	ltr.
11807	22 x 35	52	2 x 4,5

Kunststoffbehälter / canister / contenedor / réceptif

	Ø cm	ltr.
11808	24	4,5



Cerealienspender „ROTATION“

cereal dispenser
dispensador de cereales
distributeur de céréales



matt poliert, drehbarer massiver Ständer, Behälter herausnehmbar, inkl. Frischhaltedeckel
satin polished finish, rotating food, canister removable, incl. airtight covers
pulido acabado satinado, giratorio, incluye tapas herméticas
mat satiné, rotatif, inclut couvercles hermétiques

	Ø cm	↑ cm	ltr.
11970	38	54	3 x 4,5

Kunststoffbehälter / canister / contenedor / réceptif

	Ø cm	ltr.
11808	24	4,5



Cerealienspender „ROTATION“

cereal dispenser
dispensador de cereales
distributeur de céréales



Buchen-Holz versiegelt, drehbarer massiver Ständer, Behälter herausnehmbar, inkl. Frischhaltedeckel

wood beech covered waterproof, rotating food, canister removable, incl. airtight cover
tapa en madera de haya resistente al agua, pie giratorio, recipiente removable, incluye tapa hermética
couvercle en hêtre traitée contre l'humidité, pied rotatif, récipients démontables, inclut couvercles hermétiques

	Ø cm	↑ cm	ltr.
11975	38	54	3 x 4,5

CEREAL DISPENSER



Cerealienspender „CLASSIC“

cereal dispenser
dispensador de cereales
distributeur de céréales



Portionieren durch einfaches Drehen, Behälter herausnehmbar

canister removable
contenedor movable
réceptif amovible

	cm	↑ cm	ltr.
11833	35 x 26,5	68	8



Cerealienspender „CLASSIC DUO“

cereal dispenser
dispensador de cereales
distributeur de céréales



Portionieren durch einfaches Drehen, Behälter herausnehmbar

canister removable
contenedor movable
réceptif amovible

	cm	↑ cm	ltr.
11834	35 x 50	68	2 x 8



Cerealienspender „BRIDGE“

cereal dispenser
dispensador de cereales
distributeur de céréales



Behälter herausnehmbar, „Feierabend-Deckel“ für das aromadichte Lagern, portionieren durch einfaches Drehen

removable canister, special lid to keep the cereals fresh, easy to use, rotate the button to get the muesli

contenedor movable, tapa especial para mantener los cereales frescos, fácil de usar, se gira el pomo para servir los cereales

réceptif amovible, couvercle spécial pour conserver les céréales, usage facile en tournant le bouton

	cm	↑ cm	ltr.	Farbe / Colour
13987	21 x 20	55,5	4,5	Ahorn
14987	21 x 20	55,5	4,5	Wenge



Buffetständer „GOOD MORNING“

buffet stand
expositor de buffet
présentoir de buffet



4-teiliges Set: Holzständer inkl. 3 Gläser mit luftdichtem Klappdeckel

4 pcs.: wood stand included 3 glass with airtight cover

set de 4: soporte, 3 boles de cristal, cierre hermético

set de 4: présentoir, 3 bols en verre, fermeture hermétique

	cm	Farbe / Colour
13965	43 x 17	Ahorn
14965	43 x 17	Wenge

Glas mit luftdichtem Klappdeckel / glass with airtight cover / cristal, cierre hermético / verre, fermeture hermétique

	cm	↑ cm	ltr.
82328	12 x 12	22	2

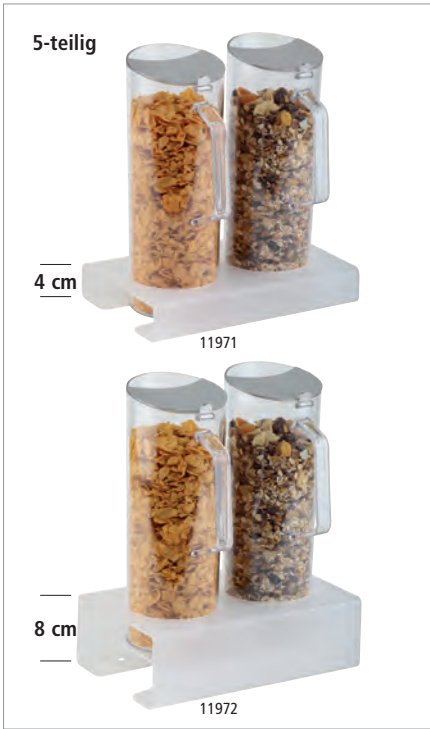

Cerealien-Bar

cereal-bar
barra para dispensador de cereales
bar à céréales



5-teiliges Set: mit Ständerhöhe 4 oder 8 cm: 1 Ständer aus Acryl gefrostet und rutschfest + 2 Karaffen mit schwenkbarem Edelstahl-Deckel + 2 luftdichte Frischhaltedeckel

5 pcs.: with stand heights 4 or 8 cm: 1 stand acryl frosted and anti-slip + 2 pitchers with stainless steel flap lid + 2 airtight covers

set de 5: stands a diferentes alturas, 4 u 8 cm: 1 stand acryl + 2 jarras con tapa de solapa de acero inoxidable + 2 tapas herméticas adicionales

set de 5: supports à différentes hauteurs: 4 ou 8 cm - 1 support acrylique satiné antiglisse + 2 pichets à céréales avec couvercle à charnière inox + 2 couvercles hermétiques

	cm	↑ cm	ltr.
11971	26 x 17	28,5	2 x 1,5
11972	26 x 17	32,5	2 x 1,5



ideal für Stufenpräsentation
best for staged presentations

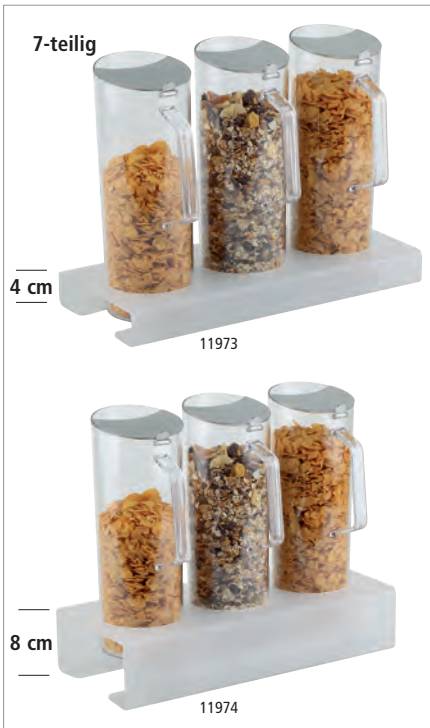

Cerealien-Bar

cereal-bar
barra para dispensador de cereales
bar à céréales



7-teiliges Set: mit Ständerhöhe 4 oder 8 cm: 1 Ständer aus Acryl gefrostet und rutschfest + 3 Karaffen mit schwenkbarem Edelstahl-Deckel + 3 luftdichte Frischhaltedeckel

7 pcs.: with stand heights 4 or 8 cm: 1 stand acryl frosted and anti-slip + 3 pitchers with stainless steel flap lid + 3 airtight covers

set de 7: con stands a diferentes alturas, 4 u 8 cm: 1 stand acryl + 3 jarras con tapa de solapa de acero inoxidable + 3 tapas herméticas adicionales

set de 7: supports à différentes hauteurs: 4 ou 8 cm - 1 support acrylique satiné antiglisse + 3 pichets à céréales avec couvercle à charnière inox + 3 couvercles hermétiques

	cm	↑ cm	ltr.
11973	38 x 17	28,5	3 x 1,5
11974	38 x 17	32,5	3 x 1,5



ideal für Stufenpräsentation
best for staged presentations



Cerealienkaraffe

cereal pitcher
jarra de cereales
pichet à céréales



schwenkbarer Edelstahl-Deckel, inkl. luftdichtem Frischhaltedeckel

stainless steel flap lid, incl. 1 airtight cover

tapa de solapa de acero inoxidable, incluye otra tapa hermética

couvercle à charnière inox + couvercle hermétique

	Ø cm	↑ cm	ltr.
10778	10	28	1,5

Frishhaltedeckel / conservation lid / tapa de conservación / couvercle

10668

NEW CANISTER



Glasdeckel mit Dichtung
glass lid with seal



1 ltr.

82265



1,2 ltr.

82266



1,5 ltr.

82267

Vorratsglas
canister with lid
bote con tapa
pot en verre avec couvercle



inkl. Glasdeckel mit Dichtung und Beschriftungsfeld, somit bleibt Ihre Ware frisch
incl. glass lid with seal and labeling field, thus, your goods remain fresh
incl. tapa de vidrio con junta y el campo de etiquetado, por lo tanto, sus productos permanecen frescos
y compris couvercle en verre avec joint et le domaine de l'étiquetage, ainsi, vos marchandises restent fraîches

	Ø cm	↑ cm	ltr.
82265	11,0	18,0	1,0
82266	11,5	19,5	1,2
82267	12,0	21,0	1,5



1,0 ltr.

82255



2,0 ltr.

82256



2,5 ltr.

82257

Vorratsglas „WOODY“
canister with lid
bote con tapa
pot en verre avec couvercle



Glasbehälter mit Holzdeckel, aromadichter Verschluss
glass container, aroma-tight screw cap
recipiente de cristal, tapa con cierre hermético para conservar el aroma
récipient en verre, couvercle avec fermeture hermétique pour conserver l'arôme

	cm	↑ cm	ltr.
82255	14 x 14	11,0	1,0
82256	14 x 14	17,0	2,0
82257	14 x 14	21,5	2,5



Holzdeckel mit Silikondichtung
wooden lid with silicone gasket



Vorratsglas „CLASSIC“

canister with lid
bote con tapa
pot en verre avec couvercle



inkl. Glasdeckel mit Dichtung, somit bleibt Ihre Ware frisch
incl. glass lid with seal, thus, your goods remain fresh
incl. tapa de vidrio con junta, por lo tanto, sus productos permanecen frescos
y compris couvercle en verre avec joint, ainsi, vos marchandises restent fraîches

	Ø cm	↑ cm	ltr.
82250	11,5	16,0	0,9
82251	14,0	21,5	2,0
82252	18,0	26,0	4,0
82253	20,0	30,0	6,0



Vorratsglas mit luftdichtem Klappdeckel

glass with airtight cover
bote con cierre hermético
pot en verre avec fermeture hermétique



	cm	↑ cm	ltr.
82328	12 x 12	22	2



Vorratsglas

canister with lid
bote con tapa
pot en verre avec couvercle



Glaskugel mit Löffel, Schraubdeckel mit aromadichtem Verschluss,
Edelstahl-Löffel mit magnetischem Silikongriff
tight cover, stainless steel spoon with magnetic silicone handle
tapa a rosca con cierre hermético, cuchara de acero inoxidable con mango de silicona magnético
couvercle à vis avec fermeture hermétique, cuillère en acier inox avec manche de silicone aimanté

	cm	↑ cm	ltr.
00636	17 x 12,5	18	1 - 2,2

CANISTER



seitlich gestellt 1 ltr.
hochkant gestellt 2,2 ltr.

Vorratsglas

canister with lid
bote con tapa
pot en verre avec couvercle



Glaskugel mit Schraubdeckel, aromadichtem Verschluss, 1 Stck.

glass ball, aroma-tight screw cap, 1 pc.

bote de cristal, tapa a rosca para conservar el aroma, 1 pza

pot en verre, couvercle à vis pour conserver l'arôme, 1 pc.

	cm	↑ cm	ltr.
00637	17 x 12,5	18	1 - 2,2



Universalbox

box / sweetbox
caja dispensadora
boîte distributrice



ideal als Verkaufsbox, mit Frontdeckel

best to present sweets etc., all-purpose, with front lid

la perfecta solución para presentar golosinas, universal, con tapa frontal

la solution idéale pour les friandises et autres, universel, avec couvercle frontal

	cm	↑ cm	Farbe / Colour
11884	23 x 14,5	15	White
11885	23 x 14,5	15	Red



Weck-Gläser mit Deckel, 2er Set

Weck-glasses with lid, 2 pcs.
Weck tarros de vidrio con tapa, set de 2
Weck verrines avec couvercle, set de 2



2 Gläser + 2 Edelstahl Deckel

2 glasses + 2 stainless steel lids

2 tarros + 2 tapas de acero inoxidable

2 verrines + 2 couvercles en acier inox

	Ø cm	↑ cm	ltr.	pcs
82239	11	7,5	0,37	2
82240	11	11	0,58	2



Weck-Gläser mit Deckel, 2er Set

Weck-glasses with lid, 2 pcs.
Weck tarros de vidrio con tapa, set de 2
Weck verrines avec couvercle, set de 2

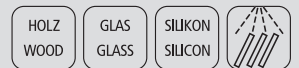

2 Gläser + 2 Holz Deckel

2 glasses + 2 wooden lids

2 tarros + 2 tapas de madera

2 verrines + 2 couvercles en bois

	Ø cm	↑ cm	ltr.	pcs
82243	11	7,5	0,37	2
82244	11	11	0,58	2

BUFFET STAND

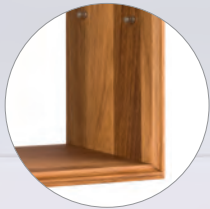

Eichenholz geölt
oak wood oiled

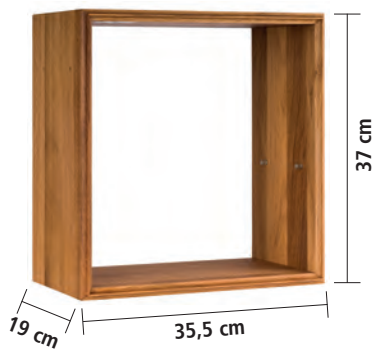

83832
Tablett / tray
GN 1/3



83832
GN 1/3



84187
GN 1/3

Buffetständer „WINDOW“

buffet stand
soporte para buffet
présentoir buffet

HOLZ
WOOD

Eichenholz geölt
oak wood oiled
madera de roble aceitada
bois de chêne huilé

	cm	↑ cm	
11740	35,5 x 19	37	inkl. 20 Haltestiften für Einlegeböden / incl. 20 fixing pins for shelves



inkl. 20 Haltestifte
incl. 20 fixing pins



Präsentationsmöglichkeiten
presentation examples



geeignet für GN 1/3 Tablett / for GN 1/3 trays / para bandejas GN 1/3 / pour plateaux GN 1/3

	cm	↑ cm	Farbe / Colour
83832	32,5 x 17,6	2,5	White
84187	32,5 x 17,6	1,5	White
84197	32,5 x 17,6	1,5	Black
83481	32,5 x 17,6	3,0	White
83491	32,5 x 17,6	3,0	Black



83481
GN 1/3

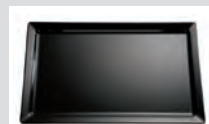

83491
GN 1/3

BUFFET BRIDGE



Präsentationsmöglichkeit / presentation opportunity



Buffetbrücke

buffet bridge
puente de buffet
pont de buffet



Buffetbrücke aus Akazienholz

buffet bridge from acacia wood
puente de buffet de madera de acacia
pont de buffet en bois d'acacia

	cm	↑ cm
33285	45 x 17	22
33286	70 x 17	22



Lieferung erfolgt demontiert
delivery disassembled



Buffetgestell

buffet stand
soporte para buffet
présentoir buffet



3-stufig, geeignet für runde und rechteckige Körbe, platzsparend zusammenklappbar

3-tier, usable for round and rectangular baskets, can be pushed together for place saving
3 alturas, apto para cestas redondas y rectangulares, se puede plegar para ahorrar espacio
3 hauteurs, pour corbeilles rondes ou rectang, la structure s'ouvre ou se ferme pour réduire l'encombrement

	cm	↑ cm
33232	59 x 30,5	59

Tisch- und Buffetkorb, rund „ECONOMIC“ / buffet basket, round / cesta de bufé redonda / corbeille de buffet ronde

	Ø cm	↑ cm	Farbe / Colour
40144	39	10	



2-stufige Etagère „IRON“

2-tier tray
bandeja con dos alturas
étagère carré 2 hauteurs



- 1 Gestell aus schwarzem Metall
- 2 Akazienholzplatten: Ø 23 cm, H: 1,5 cm / Ø 30 cm, H: 2,5 cm
- 2 Beschriftungsschilder 15 x 10,5 cm
- 1 black metal frame
- 2 acacia wood panels: Ø 23 cm, H: 1,5 cm / Ø 30 cm, H: 2,5 cm
- 2 inscription labels 15 x 10.5 cm
- 1 soporte metálico negro
- 2 tableros de madera de acacia: Ø 23 cm, H: 1,5 cm / Ø 30 cm, H: 2,5 cm
- 2 etiqueta de inscripciones 15 x 10,5 cm
- 1 support métallique noir
- 2 panneaux en bois d'acacia: Ø 23 cm, H: 1,5 cm / Ø 30 cm, H: 2,5 cm
- 2 étiquette d'inscriptions 15 x 10,5 cm

	cm	↑ cm
30334	47 x 30	44



Buffetgestell „TRIANGLE“

buffet stand
expositor de buffet
présentoir buffet



	cm	↑ cm	Farbe / Colour	
13966	53 x 21	50		Ahorn / maple
14966	53 x 21	50		Wenge / wenge



Buffetgestell „BIRDCAGE“

buffet stand
soporte para buffet
présentoir buffet



Gestell aus schwarzem Metall, inkl. 2 Akazienholzplatten / black metal frame, incl. 2 acacia wood panels / soporte metálico negro, incl. 2 tableros de madera de acacia / support métallique noir, avec 2 panneaux en bois d'acacia

	Ø cm	↑ cm
33206	26	54

Ersatz-Holzplatte / spare wooden panel / tablero de madera de recambio / panneau en bois de rechange

	Ø cm	↑ cm
33207	25	1

BUFFET DISPLAY



Dressingtopf-Display / -Station

wooden station for 3 dressing pots
expositor de madera para 3 salseras
présentoir en bois pour 3 pots à sauce



inkl. 3 Beschriftungsschilder aus Metall
incl. 3 metal labels
incl. 3 etiquetas de metal
incl. 3 étiquettes métalliques

	cm	↑ cm
84863	40 x 16	9



passend für 83311, 83867, 30060
suitable for 83311, 83867, 30060



Dressingtopf „PASTELL“

dressing pot
salsera
pot à sauce



	cm	↑ cm	ltr.	Farbe / Colour
84862	13	19,5	1,5	■
84860	13	19,5	1,5	■
84861	13	19,5	1,5	■

Beschriftungsetiketten, 72 Stück / labeling labels, 72 pcs.
etiquetas, 72 pzs / étiquettes, 72 pcs.

	cm	Farbe / Colour
00069	8 x 4,6	■



mit Antirutschfüßchen
with non-slip feet
con pies antideslizantes
avec pieds antidérapants



stapelbar
stackable
apilable
empilable



Dressingtopf, doppelwandig „PROFI“

dressing pot, double wall
salsera alta, doble pared
pot à sauce, double paroi



beste Isoliereigenschaften
best insulating properties
muy aislante
très isolant

	Ø cm	↑ cm	ltr.
30060	13	19	1,4

Beschriftungsetiketten, 72 Stück / labeling labels, 72 pcs.
etiquetas, 72 pzs / étiquettes, 72 pcs.

	cm	Farbe / Colour
00069	8 x 4,6	■



passend für 84863
suitable for 84863



Dressingtopf „CASUAL“
dressing pot
salsera
pot à sauce



	cm	↑ cm	ltr.	Farbe / Colour
83867	12	21,5	1	■



passend für 84863
suitable for 84863



Dressingtopf „CASUAL“
dressing pot
salsera
pot à sauce



	cm	↑ cm	ltr.	Farbe / Colour
83868	12	21,5	1	■



passend für 84863
suitable for 84863

Dressingtopf
dressing pot
salsera
pot à sauce



Deckel mit Löffelaussparung
cover notched for spoon
tapa agujereada para el cucharón
couvercle avec espace pour la louche

	Ø cm	↑ cm	ltr.
83309	18,5	17	2,3
83310	17,0	15	2,0
83311	13,0	13	0,8

BUFFET DISPLAY



Schale „ELEMENT“

bowl
cuenco
bol



	Ø cm	↑ cm	ltr.
30000	22	6,0 / 10,5	1,1
30001	26	7,5 / 13,0	1,7
30002	29,5	8,5 / 14,5	2,5



möbelschonende Unterseite
furniture-friendly underside



Präsentationsmöglichkeiten
presentation example



Schale „COCONUT“

bowl
cuenco
bol



	Ø cm	↑ cm	ltr.
30020	18	9,5	1
30021	23	12,5	2,2



möbelschonende Unterseite
furniture-friendly underside



Buffetständer

buffet stand
expositor de buffet
présentoir buffet



Akazienholz
acacia wood
madera de acacia
bois d'acacia

	Ø cm	↑ cm
33255	15	10
33256	25	15

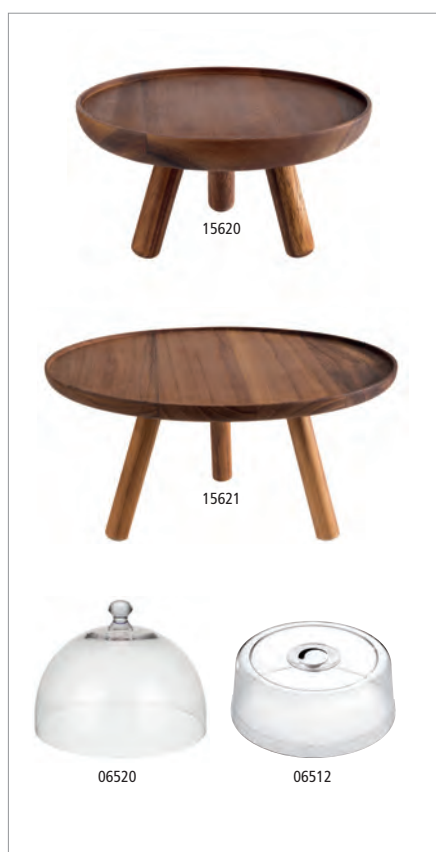

Buffetständer „ACACIA“

buffet stand
soporte para buffet
présentoir buffet



Akazienholz geölt / acacia wood oiled / madera de acacia aceitada / bois d'acacia huilé

	Ø cm	↑ cm
15620	20,0	10,5
15621	30,5	15,0
15622	30,5	20,0

Frischhalte- Haube / cover / campana / cloche



	Ø cm	↑ cm	fits to
06520	30	22	15621, 15622

Frischhalte- Haube / cover / campana / cloche



	Ø cm	↑ cm	fits to
06512	30	11,5	15621, 15622



Buffetständer „ACACIA“

buffet stand
soporte para buffet
présentoir buffet



Akazienholz geölt / acacia wood oiled / madera de acacia aceitada / bois d'acacia huilé

	cm	↑ cm	GN
15623	53 x 16,2	20	2/4



GN Abdeckhaube / GN cover / GN cubierta/ GN cloche

	cm	↑ cm	GN
11044	53 x 16,2	10,5	2/4

BUFFET DISPLAY



Die Induktionsstation mit Regler präsentiert sich in einem Set aus Walnussholz, einem schwarzen Metallständer und einer Induktionsheizung.

The induction station with controller is presented in a set of walnut wood, a black metal stand and an induction heater.

La estación de inducción con regulador se presenta en un set formado por una caja de madera de nogal, un soporte de metal negro y un calentador de inducción.

La station à induction avec température réglable se compose d'un caisson en bois noyer, d'un support métallique noir et d'une plaque à induction.



Induktionsstation, 4-teiliges Set

induction station, 4 pcs.
estación de inducción, set de 4
station d'induction, set de 4



4 teiliges Set:

- 1 Induktionskochplatte mit Regler (Ø 24 cm, 900 Watt)
- 1 Metallständer schwarz
- 1 Rahmen aus Walnussholz geölt
- 1 Edelstahlrahmen

4 pcs. set:

- 1 induction hotplate with controller (Ø 24 cm, 900 Watt)
- 1 metal stand black
- 1 frame in oiled walnut wood
- 1 stainless steel frame

set de 4:

- 1 placa de inducción con regulador (Ø 24 cm, 900 vatios)
- 1 soporte de metal negro
- 1 caja de madera de nogal aceitada
- 1 marco de acero inoxidable

set de 4:

- 1 plaque d'induction avec température réglable (Ø 24 cm, 900 watts)
- 1 support métallique noir
- 1 caisson en bois noyer huilé
- 1 cadre en acier inox

	cm	↑ cm
12270	35,4 x 32,5	19



passendes Chafing Dish Set 12330
suitable chafing dish set 12330

Ersatzteile / replacement parts / piezas de repuesto / pièces de rechange

	cm	↑ cm	
12271	35,4 x 32,5	8,5	Holzrahmen / wooden frame
12272	29,5 x 26,5	1	Edelstahlrahmen / stainless steel frame
12295	Ø 24	-	900 Watt Induktionskochplatte / induction plate
15506	35,4 x 32,5	17,6	Buffetständer schwarz / buffet stand black



Buffetleiter „BIG“

buffet ladder
dispensador en escalera
présentoir buffet en escalier



12-teiliges Set: 4 Glasschalen Ø 23 cm 2,5 Liter, 4 klappbare Schutzdeckel mit Beschriftungsfenster, 1 Leiter, 1 Doppelring, 2 Einzelringe, einfach und individuell zusammensetzbar

12 pcs. set: 4 glass bowls Ø 23 cm 2.5 litres, 4 hinged covers with card for inscription, 1 ladder, 1 double ring, 2 single rings, easy to fix and individual to use

set de 12: 4 boles vidrio Ø 23 cm 2,5 l, 4 tapas abatibles con ventana para etiqueta, 1 soporte escalera, 1 aro doble, 2 aros sencillos, fácil de montar, posible usar individualmente

set de 12: 4 bols verre Ø 23 cm 2,5 l, 4 couvercles à charnière et fenêtre p/ étiquette, 1 support escalier, 1 cercle double, 2 cercles simples, montage facile, utilisable individuellement

	cm	↑ cm
11598	39 x 31	66



Buffetleiter „BIG“

buffet ladder
dispensador en escalera
Présentoir buffet en escalier



11-teiliges Set: 6 Glasschalen Ø 23 cm 2,5 Liter, 1 Leiter, 2 Doppelringe, 2 Einzelringe, einfach und individuell zusammensetzbar

11 pcs. set: 6 glass bowls Ø 23 cm 2.5 litres, 1 ladder, 2 double rings, 2 single rings, easy and individual to use

set de 11: 6 boles vidrio Ø 23 cm 2,5 l, 1 soporte escalera, 2 aros dobles, 2 aros sencillos, fácil montar, se puede usar individualmente

set de 11: 6 bols verre Ø 23 cm 2,5 l, 1 support escalier, 2 cercles double, 2 cercles simples, montage facile, utilisable individuellement

	cm	↑ cm
11599	39 x 31	66

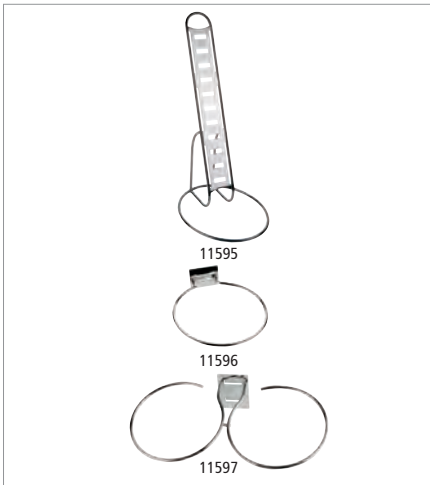

Einzelteile / spare parts / piezas sueltas / pièces détachées

Leitergestell / frame / marco solo en escalera / échelle support

	cm	↑ cm
11595	39 x 31	66

Einzelring / single ring / aro sencillo / cercle simple

	Ø cm
11596	23,5

Doppelring / double ring / aro doble / cercle double

	cm
11597	48 x 23,5



Schale

bowl
cuenco
bol



	Ø cm	↑ cm	ltr.
11875	23	10,5	2,5



Schutzdeckel mit Löffelaussparung

cover
tapa
couvercle



	Ø cm
11878	23,5

BUFFET DISPLAY



jede Schale /
each bowl
ca. 0,5 ltr.

Buffetleiter „LITTLE“

buffet ladder
dispensador en escalera
présentoir buffet en escalier



12-teiliges Set: 4 Glasschalen Ø 14 cm 0,5 Liter, 4 klappbare Schutzdeckel mit Beschriftungsfenster, 1 Leiter, 1 Doppelring, 2 Einzelringe, einfach und individuell zusammensetzbar

12 pcs. set: 4 glass bowls Ø 14 cm 0.5 litres, 4 hinged covers with card for inscription, 1 ladder, 1 double ring, 2 single rings, easy and individual to use

set de 12: 4 boles vidrio Ø 14 cm 0,5 l, 4 tapas abatibles con ventana para etiqueta, 1 soporte escalera, 1 aro doble, 2 aros sencillos, fácil montaje, se puede usar individualmente

set de 12: 4 bols verre Ø 14 cm 0,5 l, 4 couvercles à charnière et fenêtre p/ étiquette, 1 support escalier, 1 cercle double, 2 cercles simples, montage facile, utilisable individuellement

	cm	↑ cm
11498	30 x 30	48



jede Schale /
each bowl
ca. 0,5 ltr.

Buffetleiter „LITTLE“

buffet ladder
dispensador en escalera
Présentoir buffet en escalier



11-teiliges Set: 6 Glasschalen Ø 14 cm 0,5 Liter, 1 Leiter, 2 Doppelringe, 2 Einzelringe, einfach und individuell zusammensetzbar

11 pcs. set: 6 glass bowls Ø 14 cm 0.5 litres, 1 ladder, 2 double rings, 2 single rings, easy and individual to use

set de 11: 6 boles vidrio Ø 14 cm 0,5 l, 1 soporte escalera, 2 aros dobles, 2 aros sencillos, fácil montaje, se puede usar individualmente

set de 11: 6 bols verre Ø 14 cm 0,5 l, 1 support escalier, 1 cercle double, 2 cercles simples, montage facile, utilisable individuellement

	cm	↑ cm
11499	30 x 30	48

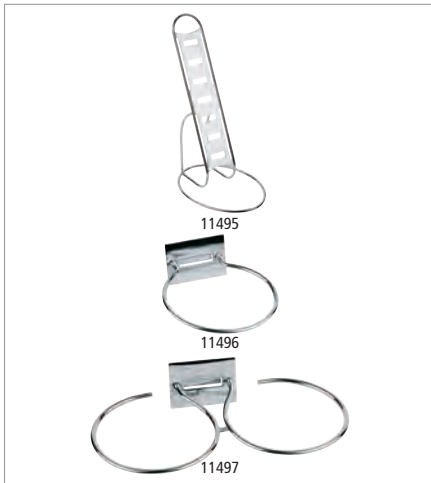

Einzelteile / spare parts / piezas sueltas / pièces détachées

Leitergestell / frame / marco solo en escalera / échelle support

	Ø cm	↑ cm
11495	30	48

Einzelring / single ring / aro sencillo / cercle simple

	Ø cm
11496	14

Doppelring / double ring / aro sencillo / cercle double

	cm	cm
11497	29,5 x 14,5	48



0,5 ltr.

Schale

bowl
cuenco
bol



	Ø cm	↑ cm	ltr.	pcs.
11865	14	6,5	0,5	6



Schutzdeckel mit Löffelaussparung

cover
tapa
couvercle



	Ø cm
11868	14,5



Buffetgestell „SUNDAY“

buffet stand
expositor bufé
présentoir buffet



7-teiliges Set: 3 Glasschalen Ø 23 cm (2,5 Liter), 3 klappbare Schutzdeckel, 1 Gestell

7 pcs. set: 3 glass bowls Ø 23 cm (2,5 litres), 3 hinged covers, 1 stand

set de 7: 3 boles vidrio Ø 23 cm (2,5 l), 3 tapas con bisagra, 1 soporte

set de 7: 3 bols verre Ø 23 cm (2,5 l), 3 couvercles à charnière, 1 support

	cm	↑ cm
11795	61 x 24	35



Buffetständer „BIG“

buffet stand
expositor de buffet
présentoir buffet



7-teiliges Set: 3 Glasschalen Ø 23 cm 2,5 Liter, 3 klappbare Schutzdeckel, 1 Ständer

7 pcs. set: 3 glass bowls Ø 23 cm 2.5 litres, 3 hinged covers, 1 stand

set de 7: 3 boles vidrio Ø 23 cm, 2,5 l, 3 tapas con bisagra, 1 soporte

set de 7: 3 bols verre Ø 23 cm 2,5 l, 3 couvercles à charnière, 1 support

	cm	↑ cm
11892	50 x 50	18



Buffetständer „LITTLE“

buffet stand
expositor de buffet
présentoir buffet



7-teiliges Set: 3 Glasschalen Ø 14 cm 0,5 Liter, 3 klappbare Schutzdeckel, 1 Ständer

7 pcs. set: 3 glass bowls Ø 14 cm 0,5 l, 3 hinged covers, 1 stand

set de 7: 3 boles vidrio Ø 14 cm, 0,5 l, 3 tapas con bisagra, 1 soporte

set de 7: 3 bols verre Ø 14 cm 0,5 l, 3 couvercles à charnière, 1 support

	cm	↑ cm
11893	30 x 30	14

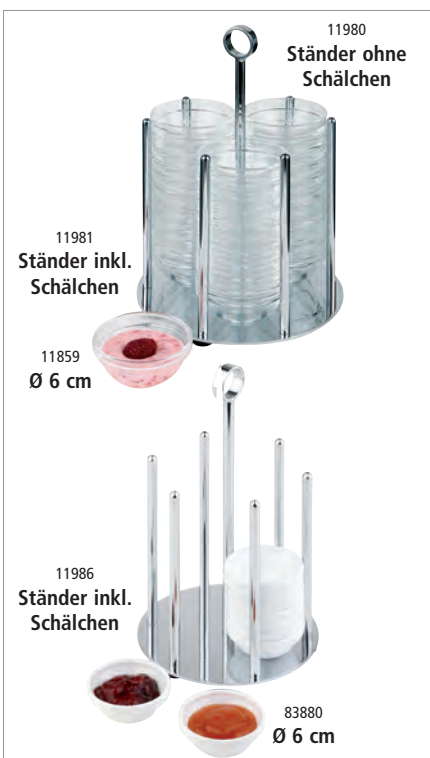

Schälchenspender „MINI“

bowl holder
rack dispensador para bols
porte-bols



geeignet für Schalen Ø 6 cm, bestückbar mit bis zu 36 Schalen

for bowls Ø 6 cm, suitable for 36 bowls

para bols de Ø 6 cm, apto para 36 bols

pour bols de Ø 6 cm, maxi 36 bols

	Ø cm	↑ cm	
11981	14	25,5	Ständer inkl. 36 Glasschalen, Ø 6 cm frame with 36 bowls, Ø 6 cm
11986	14	25,5	Ständer inkl. 36 Melaminschalen, Ø 6 cm frame with 36 melamine bowls, Ø 6 cm

Schälchenspender „MINI“ / bowl holder / rack dispensador para bols / porte-bols

	Ø cm	↑ cm	
11980	14	25,5	Ständer ohne Schalen / frame without bowls soporte sin bols / support sans bols

BUFFET DISPLAY



passende Gläser / matching glasses
82310, 82312, 82314

Serviergestell „WECK“

serving stand
expositor
présentoir

ohne Gläser
without glasses
sin vasos
sans verrines



	Ø cm	↑ cm	
33247	22	33	6 x Ø 6 cm



passende Gläser / matching glasses
82310, 82312, 82314

Serviergestell „WECK“

serving stand
expositor
présentoir

ohne Gläser
without glasses
sin vasos
sans verrines



	Ø cm	↑ cm	
33246	22	59	12 x Ø 6 cm



Weck-Gläser mit Deckel, 12er Set

Weck-glasses with lid, 12 pcs.
Weck tarros de vidrio con tapa, set de 12
Weck verrines avec couvercle, set de 12



12 Gläser + 12 Deckel
12 glasses + 12 covers
12 vasos + 12 tapas
12 verrines + 12 couvercles

	Ø cm	↑ cm	ltr.	pcs
82310	6	5,5	0,08	12
82312	6	7,0	0,14	12
82314	6	8,0	0,16	12

BUFFET LADDER GN



Buffetleiter „LITTLE GN 1/3“

buffet ladder
dispensador en escalera
présentoir buffet en escalier



4-teilig: 1 Leiter-Gestell, 3 GN 1/3 Rahmen
4 pcs.: 1 ladder, 3 single rings GN 1/3
4 pz: 1 soporte escalera, 3 aros sencillos GN 1/3
4 pc: 1 support escalier, 3 cercles simples GN 1/3

	cm	↑ cm	fits to
11526	31,5 x 32	48	baskets / pans GN 1/3



Buffetleiter „LITTLE GN 1/2“

buffet ladder
dispensador en escalera
présentoir buffet en escalier



4-teilig: 1 Leiter-Gestell, 3 GN 1/2 Rahmen
4 pcs.: 1 ladder, 3 single rings GN 1/2
4 pz: 1 soporte escalera, 3 aros sencillos GN 1/2
4 pc: 1 support escalier, 3 cercles simples GN 1/2

	cm	↑ cm	fits to
11527	31,5 x 41,5	48	baskets / pans GN 1/2

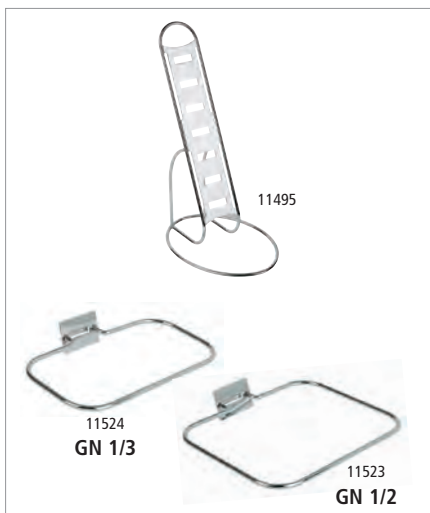

Einzelteile / spare parts / piezas sueltas / pièces détachées

Leitergestell / frame / marco solo en escalera / échelle support

11495

Einzelring GN 1/3 / single ring GN 1/3 / aro sencillo GN 1/3 / cercle simple GN 1/3

11524

Einzelring GN 1/2 / single ring GN 1/2 / aro sencillo GN 1/2 / cercle simple GN 1/2

11523

BUFFET DISPLAY



Buffetleiter „BIG GN 1/2“
buffet ladder
dispensador en escalera
présentoir buffet en escalier



5-teilig: 1 Leiter-Gestell, 4 GN 1/2 Rahmen
5 pcs.: 1 ladder, 4 single rings GN 1/2
5 pz: 1 soporte escalera, 4 aros sencillos GN 1/2
5 pc: 1 support escalier, 4 cercles simples GN 1/2

	cm	↑ cm	fits to
11528	31,5 x 56	66	baskets / pans GN 1/2



Buffetleiter „BIG GN 1/1“
buffet ladder
dispensador en escalera
présentoir buffet en escalier



4-teilig: 1 Leiter-Gestell, 3 GN 1/1 Rahmen
4 pcs.: 1 ladder, 3 single rings GN 1/1
4 pz: 1 soporte escalera, 3 aros sencillos GN 1/1
4 pc: 1 support escalier, 3 cercles simples GN 1/1

	cm	↑ cm	fits to
11529	52 x 59	66	baskets / pans GN 1/1

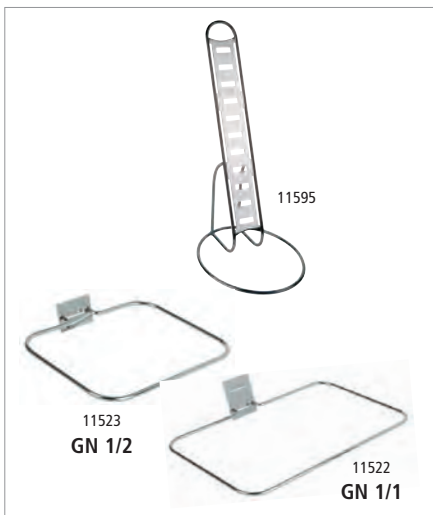

Einzelteile / spare parts / piezas sueltas / pièces détachées

Leitergestell / frame / marco solo en escalera / échelle support

11595

Einzelring GN 1/2 / single ring GN 1/2 / aro sencillo GN 1/2 / cercle simple GN 1/2

11523

Einzelring GN 1/1 / single ring GN 1/1 / aro sencillo GN 1/1 / cercle simple GN 1/1

11522



Serviergestell „S-PURE“

serving stand
soporte buffet
support buffet



für 3 Tablett quadratisch 83407 oder 83418

for 3 trays square 83407 or 83418

para 3 bandejas cuadradas 83407 o 83418

pour 3 plats carrés 83407 ou 83418

	cm	↑ cm
33226	29 x 17	41



Serviergestell „M-PURE“

serving stand
soporte buffet
support buffet



für 3 Tablett quadratisch 83406 oder 83407

for 3 trays square 83406 or 83407

para 3 bandejas cuadradas 83406 o 83407

pour 3 plats carrés 83406 o 83407

	cm	↑ cm
33227	33 x 21	44



Serviergestell „L-PURE“

serving stand
soporte buffet
support buffet



für 3 Tablett rechteckig 83417

for 3 trays rectangular 83417

para 3 bandejas rectangulares 83417

pour 3 plats rectangulaires 83417

	cm	↑ cm
33228	37 x 21	44



GN Serviergestell „XL-PURE“

GN serving stand
GN soporte buffet
GN support buffet



passend für Tablett GN 1/1, GN 1/2, GN 1/3, GN 2/4

suitable for tray GN 1/1, GN 1/2, GN 1/3, GN 2/4

aptas para bandejas GN 1/1, GN 1/2, GN 1/3, GN 2/4

convient pour les plats GN 1/1, GN 1/2, GN 1/3, GN 2/4

	cm	↑ cm
33222	63 x 27	44,5

BUFFET DISPLAY



Buffetgestell „FLOAT SMALL“

buffet stand
soporte buffet
support buffet



Metall verchromt, für 3 Schalen Nr. 83916, 83917
metal chrome plated, for 3 bowls no. 83916, 83917
metal cromado, para 3 cuencos N° 83916, 83917
métal chromé, pour 3 coupelles 83916, 83917

	cm	↑ cm
33241	55,5 x 19	15,5

Schale „FLOAT“ / bowl / cuenco / bol

	cm	↑ cm	Farbe / Colour
83916	19 x 19	9,5	White
83917	19 x 19	9,5	Black



High Tea Rack

High Tea Rack
rack de te alto
étagère à thé avec anse supérieure



Holz dunkelbraun, Edelstahlgriff, 4 große Fächer 15 x 10 x 10 cm,
3 kleine Fächer 9,5 x 9,5 x 10 cm

rubber wood in dark brown, stainless handle, 4 big compartments 15 x 10 x 10 cm, 3 small compartments 9,5 x 9,5 x 10 cm

madera marrón oscura, mango de acero inoxidable, 4 compartimentos grandes 15 x 10 x 10 cm, 3 compartimentos pequeños 9,5 x 9,5 x 10 cm

bois marron foncé, poignée inox, 4 compartiment grand 15 x 10 x 10 cm, 3 compartiment petit 9,5 x 9,5 x 10 cm

	cm	↑ cm
33210	34 x 10	38



Serviergestell, 2-stufig

serving stand, 2-tier
soporte platos, 2 alturas
présentoir, 2 hauteurs



3 tlg. Set: 1 Gestell aus Akazienholz, 2 Schieferplatten, zusammenklappbar

3 pcs.: 1 stand acacia wood, 2 slate tray, foldable

set de 3: 1 soporte madera de acacia, 2 bandeja de pizarra, fácil de plegar

set de 3: 1 présentoir au pour tous les seaux à FRAMES



zusammenklappbar
foldable

	cm	↑ cm
00958	36,5	34 x 26,5



Brezel- oder Wurstständer

pretzel-/ sausage stand
soporte para embutidos
support à bretzel ou à saucissons



Verkaufsständer Buchen-Holz versiegelt, bestens geeignet für die Präsentation von Brezeln, Würstchen, etc., Fuß Ø 22 cm

beech wood, ideal to present pretzels, sausages, etc.

	Ø cm	↑ cm
79553	28	50

Hygieneschutz für Brezelständer / hygienic cover / cubierta higiénica antialiento / pare-haleine

	cm	↑ cm
11557	20 x 20 x 20	50
11558	15 x 20 x 15	50



2-stufige Etagère

2-tier tray
soporte 2 alturas
étagère 2 niveaux



1 Gestell aus Metall schwarz, mit Antirutschfüßchen,
2 herausnehmbare Bretter aus geöltem Akazienholz (34,5 x 20,5 x 1,5 cm) / (34,5 x 13 x 1,5 cm)
8 Beschriftungsschilder (8 x 4 cm)

1 frame made of black metal with non-slip feet,
2 removable trays made of accacia wood (34,5 x 20,5 x 1,5 cm) / (34,5 x 13 x 1,5 cm)
8 labelling plates (8 x 4 cm)

1 soporte metálico, negro con pies antideslizantes,
2 extraíble bandejas extraíbles devmadera de acacia (34,5 x 20,5 x 1,5 cm) / (34,5 x 13 x 1,5 cm)
8 etiquetas (8 x 4 cm)

1 support métallique noir avec pieds antidérapants,
2 amovible planches amovibles en bois d' acacia (34,5 x 20,5 x 1,5 cm) / (34,5 x 13 x 1,5 cm)
8 étiquettes (8 x 4 cm)

	cm	↑ cm
30339	35,5 x 21	40

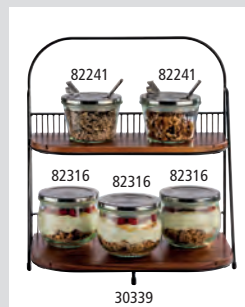

Präsentationsmöglichkeiten mit Antirutsch-Füßchen
presentation examples with non-slip feet

geöltes Akazienholz
oiled acacia wood



2-stufige Etagère „IRON“

2-tier tray
bandeja con dos alturas
étagère carré 2 hauteurs



1 Gestell aus schwarzem Metall
2 Akazienholzplatten: Ø 23 cm, H: 1,5 cm / Ø 30 cm, H: 2,5 cm
2 Beschriftungsschilder 15 x 10,5 cm

1 black metal frame
2 acacia wood panels: Ø 23 cm, H: 1,5 cm / Ø 30 cm, H: 2,5 cm
2 inscription labels 15 x 10.5 cm

1 soporte metálico negro
2 tableros de madera de acacia: Ø 23 cm, H: 1,5 cm / Ø 30 cm, H: 2,5 cm
2 etiqueta de inscripciones 15 x 10,5 cm

1 support métallique noir
2 panneaux en bois d'acacia: Ø 23 cm, H: 1,5 cm / Ø 30 cm, H: 2,5 cm
2 étiquette d'inscriptions 15 x 10,5 cm

	cm	↑ cm
30334	47 x 30	44

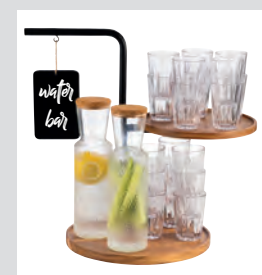
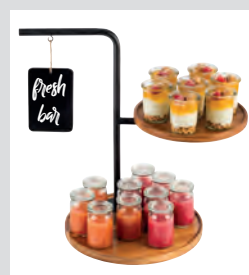

Präsentationsmöglichkeiten
presentation examples



1 x Gestell / 1 x frame



2 x Korb / 2 x basket

5 tlg.
5 pcs.



2 x Tablett / 2 x tray



Korb / basket 30337



Tablett / tray 30338

2-stufige Etagère „ALL-ROUNDER“, 5er Set

2-tier tray, 5 pcs.

soporte 2 alturas, set de 5

étagère 2 niveaux, set de 5



5 teiliges Set:

- 1 Gestell aus Metall schwarz, mit Antirutschfüßchen,
- 2 Körbe aus Metall schwarz je 29 x 16 cm, H: 7 cm,
- 2 herausnehmbare Bretter aus geöltem Akazienholz je 28,5 x 15,5 cm, H: 1,5 cm

5 pcs.:

- 1 frame made of black metal with non-slip feet,
- 2 removable baskets of black metal each 29 x 16 cm, H: 7 cm,
- 2 boards of oiled acacia wood each 28,5 x 15,5 cm, H: 1,5 cm

set de 5:

- 1 support métallique, negro con pies antideslizantes,
- 2 cestas metálicas negras, cada una de 29 x 16 cm, H: 7 cm,
- 2 tablas de madera de acacia aceiteada 28,5 x 15,5 cm, H: 1,5 cm

set de 5:

- 1 support métallique noir avec pieds antidérapants,
- 2 paniers métalliques noirs, chacune 29 x 16 cm, H: 7 cm,
- 2 planches d'acacia huilé, chacune 28,5 x 15,5 cm, H: 1,5 cm

	cm	↑ cm
30336	31 x 17	37,5

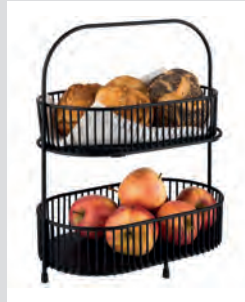

multifunktional,
ideal als

- Frühstück-Etagère
- Vorspeisen-Etagère
- Kuchen-Etagère
- Brot-Etagère
- Gebäck-Etagère
- Früchte-Etagère

Präsentationsmöglichkeiten
presentation examples



geöltes Akazienholz
oiled acacia wood

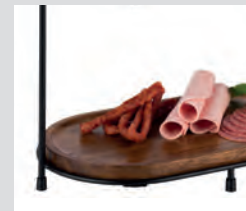

mit Antirutsch-Füßchen
with non-slip feet

Korb / basket / cesta / corbeille

	cm	↑ cm	Farbe / Colour
30337	29 x 16	7	■

Servierbrett / serving board / tabla de servir / planche de service

	cm	↑ cm	Farbe / Colour
30338	28,5 x 15,5	3,5	■



Serviergestell
29 x 19,5 cm | H 43 cm
no. 33220 35,00 €



Serviergestell „INDUSTRIAL“

servicing stand
soporte platos
présentoir à assiettes



für Teller max. Ø 27 cm, innerer Ring Ø 18 cm, Lieferung ohne Teller
for plates max. Ø 27 cm, circle inside Ø 18 cm, delivery without dishes
para platos máx. Ø 27 cm, aro interior Ø 18 cm, se entrega sin platos
pour assiettes Ø 27 cm maxi., anneau intérieur Ø 18 cm, livré sans assiettes

	cm	↑ cm		passend für Tellerabdeckhauben / suitable for plate cover
33208	29 x 19,5	30	2 Teller Ø 27 cm innerer Ring Ø 18 cm	11051, 11052
33209	29 x 19,5	43	3 Teller Ø 27 cm innerer Ring Ø 18 cm	11051, 11052



2-stufige Etagère

2-tier étagère
cesta doble 2 alturas
étagère 2 paniers



Griff aus Holz, Körbe aus Metall schwarz,
oberer Korb (Ø 22 cm, H: 6 cm), unterer Korb (Ø 26 cm, H: 8 cm)
wooden handle, baskets made of metal black,
upper basket (Ø 22 cm, H: 6 cm), lower basket (Ø 26 cm, H: 8 cm)
mango de madera, soporte metálico negro,
cesta superior (Ø 22 cm, H: 6 cm), cesta inferior (Ø 26 cm, H: 8 cm)
manche en bois, paniers en métal noir,
panier supérieur (Ø 22 cm, H: 6 cm), panier inférieur (Ø 26 cm, H: 8 cm)

	Ø cm	↑ cm
30335	26	48



Präsentationsmöglichkeiten
presentation examples

ETAGERE

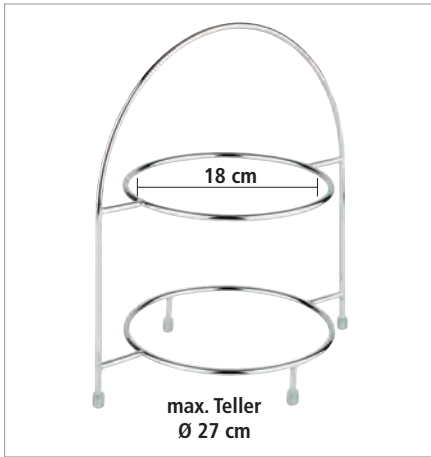

Serviergestell

serving stand
soporte platos
présentoir à assiettes



für 2 Teller max. Ø 27 cm, innerer Ring Ø 18 cm
for 2 plates max. Ø 27 cm, circle inside Ø 18 cm
para 2 platos Ø 27 cm, interior aro Ø 18 cm
pour 2 assiettes maxi Ø 27 cm, cercle Ø int. 18 cm

	cm	↑ cm	Farbe / Colour
33219	29 x 19,5	30	



Serviergestell

serving stand
soporte platos
présentoir à assiettes



für 3 Teller max. Ø 17 cm, innerer Ring Ø 10,5 cm
for 3 plates max. Ø 17 cm, circle inside Ø 10,5 cm
para 3 platos Ø 17 cm, interior aro Ø 10,5 cm
pour 3 assiettes maxi Ø 17 cm, cercle Ø int. 10,5 cm

	cm	↑ cm	Farbe / Colour
33215	18,5 x 15,5	26	chrome
33211	18,5 x 15,5	26	copper



Serviergestell

serving stand
soporte platos
présentoir à assiettes



für 3 Teller max. Ø 27 cm, innerer Ring Ø 18 cm
for 3 plates max. Ø 27 cm, circle inside Ø 18 cm
para 3 platos Ø 27 cm, interior aro Ø 18 cm
pour 3 assiettes maxi Ø 27 cm, cercle Ø int. 18 cm

	cm	↑ cm	Farbe / Colour
33220	29 x 19,5	43	chrome
33212	29 x 19,5	43	copper

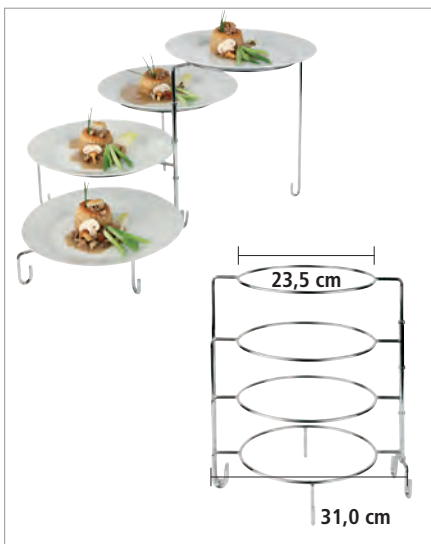

Serviergestell

serving stand
soporte platos
présentoir à assiettes



für 4 Teller (max. Ø 31 cm), platzsparend zusammendrehbar, Lieferung ohne Teller
for 4 plates (max. Ø 31 cm), can be pushed together for place saving, without dishes
para 4 platos (max. Ø 31 cm) se puede plegar para ahorrar espacio, se sirve sin platos
pour 4 assiettes (maxi Ø 31 cm), peut se refermer pour réduire l'encombrement, livré sans assiettes

	Ø cm	↑ cm
33225	34	37

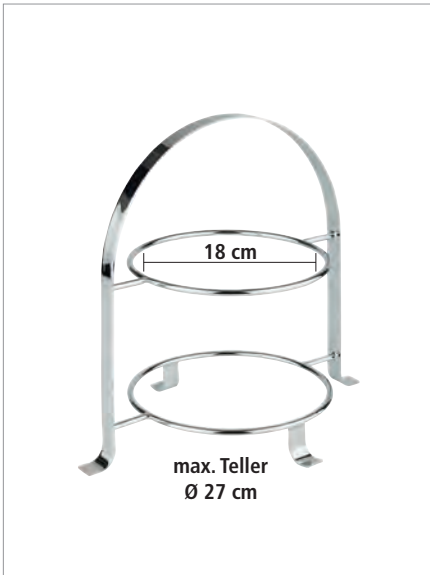

Serviergestell

servicing stand
soporte platos
présentoir à assiettes



für 2 Teller max. Ø 27 cm, innerer Ring Ø 18 cm, Lieferung ohne Teller
for 2 plates max. Ø 27 cm, circle inside Ø 18 cm, without dishes
para 2 platos Ø 27 cm, interior aro Ø 18 cm, se entrega sin platos
pour 2 assiettes maxi Ø 27 cm, cercle Ø int. 18 cm, livré sans assiettes

	cm	↑ cm
33214	33 x 23,5	30

für 3 Teller max. Ø 27 cm, innerer Ring Ø 18 cm
for 3 plates max. Ø 27 cm, circle inside Ø 18 cm
para 3 platos Ø 27 cm, interior aro Ø 18 cm
pour 3 assiettes maxi Ø 27 cm, cercle Ø int. 18 cm

	cm	↑ cm
33217	33 x 24	43



Serviergestell

servicing stand
soporte platos
présentoir à assiettes



für 3 Teller max. Ø 17 cm, innerer Ring Ø 10,5 cm
for 3 plates max. Ø 17 cm, circle inside Ø 10,5 cm
para 3 platos Ø 17 cm, interior aro Ø 10,5 cm
pour 3 assiettes maxi Ø 17 cm, cercle Ø int. 10,5 cm

	cm	↑ cm
33216	22,5 x 16,5	25,5



2-stufige Etagère

2-tier tray
bandeja dos alturas
étagère carré 2 hauteurs



Naturschiefer
natural slate tray
bandeja de pizarra natural
plateau ardoise naturelle

	Ø cm	↑ cm	✦ mm
00989	25 / 20	24	6 - 9



3-stufige Etagère

3-tier tray
bandeja con tres alturas
étagère carré 3 hauteurs



Naturschieferplatte, Akazienholz
natural slate tray, wood akazie
bandeja de pizarra natural, madera de acacia
plateau ardoise naturelle, bois d'acacia

	Ø cm	↑ cm	✦ mm
00960	30 / 25 / 20	34	6 - 9

ETAGERE



Etagère etagère frutero corbeille à fruits



ergonomischer Griff, stehend auf schwarzen Antirutsch-Füßen
ergonomic handle, anti-slip-feet
asa ergonómica, pies antideslizantes color negro
anse ergonomique, pieds antidérapants noirs

	cm	↑ cm
30325	30 x 30	35,5



Etagère „FINESSE“ etagère frutero étagère



vergoldeter Messing-Kugelgriff, einfache Montage
gold plated knob, easy to assemble
botón dorado, fácil de montar
bouton doré, montage facile

	Ø cm	↑ cm	
33248	48 / 38 / 32	50	3-stufig / 3-tier 3 alturas / 3 niveaux
33238	38 / 32	30	2-stufig / 2-tier 2 alturas / 2 niveaux



Etagère „CASUAL“ etagère expositor de bombones o bocaditos présentoir à mignardises



inklusive Edelstahl-Schild, beschriftbar
including sign
placa incluida, sin inscripción
étiquette incluse, sans inscription

	Ø cm	↑ cm	
34248	31 - 41 - 51	55	3-stufig / 3-tier 3 niveles / 3 étages



Serviergestell serving stand expositor présentoir



3-stufig für quadratische Teller / Platten in 3 verschiedenen Größen:
z.B. 83407 + 83406 + 83405, Lieferung ohne Teller/Platten

3-tier for square dishes / plates in 3 different sizes: e.g. 83407 + 83406 + 83405,
delivery without dishes / plates

3 alturas para platos cuadrados fuentes en 3 diferentes medidas p.e. 83407 + 83406 + 83405,
se entrega sin platos/ fuentes

3 niveaux pour assiettes ou plats carrés de différentes dimensions, ex. 83407 + 83406 + 83405,
livré sans assiettes

	cm	↑ cm
33231	37,5 x 37,5	50

**Teebox**

tea-box
caja para té
boîte à thé et infusions



Holzbox mit Sichtfenster, mit Aufschrift „Tee“, 4 Kammern können mit je 30 kuvertierten Teebeuteln bestückt werden

wooden box with clear transparent window, with inscription „Tee“, 4 chambers for approx. 30 tea bags each

caja de madera clara con ventana transparente, con inscripción „Tee“, 4 compartimentos, para aproximadamente 30 bolsas de té

en bois clair avec fenêtre, marquée „TEE“, 4 compartiments, pour environ 30 sachets

	cm	↑ cm	Farbe / Colour	
11575	33,5 x 20	9		
11574	33,5 x 20	9		
	cm	↑ cm	Farbe / Colour	
11576	33,5 x 20	9		ohne Aufschrift / without inscription sin inscpción / sans inscription

**Teebox**

tea-box
caja para té
boîte à thé et infusions



Holzbox mit Sichtfenster, mit Aufschrift „Tee“, 12 Kammern können mit je 12 kuvertierten Teebeuteln bestückt werden

wooden box with clear transparent window, with inscription „Tee“, 12 chambers for approx. 144 tea bags each

caja de madera clara con ventana transparente, con inscripción „Tee“, 12 compartimentos, para aproximadamente 144 bolsas de té

en bois clair avec fenêtre, marquée „TEE“, 12 compartiments, pour environ 144 sachets

	cm	↑ cm	Farbe / Colour	
11775	31 x 28	9		
11776	31 x 28	9		

**Teebox / Multibox**

tea caddy
caja para té
boîte à thé et infusions



3 Fächer für kuvertierte Teebeutel, 1 Fach für Zucker, Kekse, etc., Deckel aufklappbar

4 chambers

4 compartimentos

4 compartiments

	cm	↑ cm	
11563	22 x 17	9	

**Sortierbox „MULTI“**

shape sorter
caja surtida
boîte de tri



inklusive 3 herausnehmbare Trennwände, 4 Kammern

including 3 removable divider, 4 chambers

con 3 divisores extraíbles, 4 compartimentos

avec 3 parois de séparation amovibles, 4 compartiments

	cm	↑ cm	ltr.	Farbe / Colour
84531	31,5 x 17,5	7	2,1	
84532	31,5 x 17,5	7	2,1	

BUFFET DISPLAY

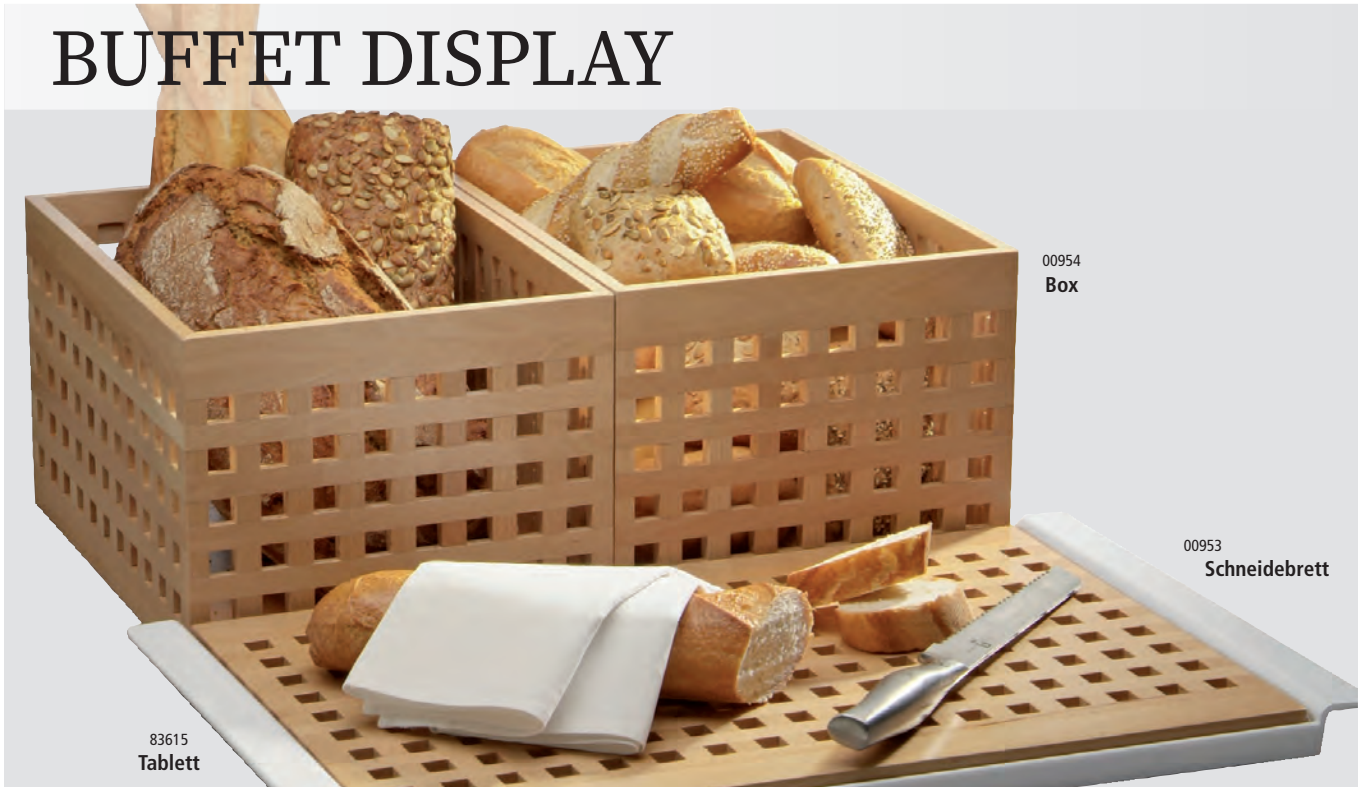

83615
Tablett

00954
Box

00953
Schneidebrett



Tablett „BROTSTATION“

tray
bandeja
plateau

Antirutsch-Füßchen
non-slip feet
pies antidesslizantes
pieds antiglisse



	cm	↑ cm
83615	59,5 x 35,5	3,5



00953
Schneidebrett

83615
Tablett

Brotschneidebrett „BROTSTATION“

cutting board
tabla de corte
planche à découper

Buchen-Holz
beech
haya
hêtre



	cm	↑ cm
00953	52 x 34	2

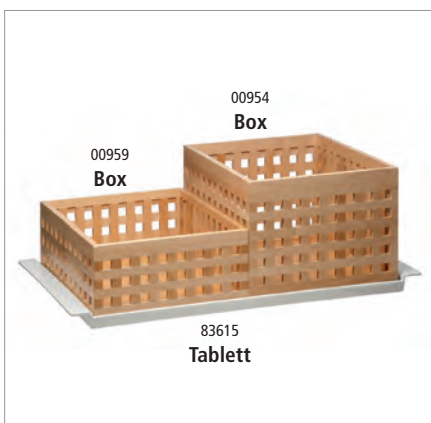

00954
Box

00959
Box

83615
Tablett

Box „BROTSTATION“

box
caja de pan para el buffet
boîte à pain pour le buffet

Buchen-Holz
beech
haya
hêtre



	cm	↑ cm
00959	34 x 26	12,5
00954	34 x 26	20,0



Brotschneidebrett „PROFI“

cutting board
tabla para cortar
planche à découper



	cm	↑ cm
00806	58 x 37,5	4



Brotschneidebrett „LETTER“

cutting board
tabla para cortar
planche à découper



	cm	↑ cm
00886	48 x 34	3,5



Brotschneidebrett „AKAZIA“

cutting board
tabla para cortar
planche à découper



	cm	↑ cm	GN
00883	47,5 x 32,0	2	
00884	53,0 x 32,5	2	1/1
00885	60,0 x 40,0	2	



praktisches Krümfach
practical crump shelf



Brotschneidebrett „RUBBERWOOD“

cutting board
tabla para cortar
planche à découper



	cm	↑ cm	GN
00955	47,5 x 32,0	2	
00956	53,0 x 32,5	2	1/1
00957	60,0 x 40,0	2	



Brotschneidebrett, 2-teilig

cutting board, 2 pcs.
tabla para cortar, set de 2
planche à découper, set de 2



2-tlg. Set: GN 1/1 Behälter, 20 mm tief, dient als Krümfach
2 pcs.: GN 1/1 pan 20 mm, bread crump shelf
set de 2: tabla de corte + bandeja inox GN 1/1 alt 20 mm (sirve para recoger las migas)
set de 2: planche à découper bois + plateau inox GN 1/1 Ht 20 mm (sert de ramassemiesettes)

	cm	GN
00951	53 x 32,5	1/1

einzelnes Brett / separate board / tabla por separado / planche seule

	cm	GN
00952	53 x 32,5	1/1

BUFFET GUARD

3 Höhen einstellbar
3 heights adjustable



schwenkbar
swivelling

Servierbeispiel
presentation example



Hygieneschutz „BUFFET GUARD“

sneeze guard
protector anti aliento
pare-haleine



- transparente, höhenverstellbare Acrylplatte 80 x 53 cm
- Neigungswinkel stufenlos einstellbar
- transparent, height-adjustable acrylic plate 80 x 53 cm
- tilt angle continuously adjustable
- placa acrílica transparente y de altura ajustable 80 x 53 cm
- el ángulo de inclinación es infinitamente variable
- plaque en acrylique transparente 80 x 53 cm et réglable en hauteur
- angle d'inclinaison variable à l'infini

	cm	↑ cm	✱ mm	Fuß / base
98120	93 x 53	50,5	5	Metall schwarz / metal black



Antirutsch-Füßchen
non-slip feet



Der Neigungswinkel der Acrylplatte ist flexibel einstellbar
the angle of inclination of the acrylic plate is flexibly adjustable



Höheneinstellung der Acrylplatte in
3 Höhen (20 cm - 30 cm - 40 cm)
height adjustment of the acrylic plate
in 3 steps. (20 cm - 30 cm - 40 cm)



Schalen / bowls 25 x 25 cm
6 x 83918
Anwendungsbeispiel
application example



Lieferung erfolgt demontiert
delivery takes place disassembled



mit Seitenschutz
.....▶

Foto: Bäckerei Vielhaber Stockum



Thekendisplay
showcase
vitrina de mostrador
vitrine de comptoir



mit Antirutsch-Füßchen, Seitenwände herausnehmbar
with non-slip feet, removable side panels
con pies antideslizantes, paneles laterales desmontables
avec pieds antidérapants, panneaux latéraux amovibles

	cm	↑ cm	fits to
98129	56,0 x 20	21,0	
98130	56,0 x 33	21,0	1 x GN 1/1, 2 x GN 1/2
98131	82,5 x 33	22,5	
98132	102,5 x 33	25,5	3 x GN 1/2



Servierbeispiele
presentation example



SPRAY



Berührungslose Handdesinfektion!
touchless hand disinfection!

Disinfect your hands

STOP

**Informations-
tafel als
Wendeschild**
Information board
as a turning sign

98250

Wandversion
wall version

Tischversion
table version

98255 **98260**

**Nicht im Lieferumfang:
Batterien und Desinfektionsmittel**
Not included: batteries and disinfectant

Desinfektionsständer „SPRAY“

disinfection stand
estación de desinfección
stand de désinfection



Desinfektionsständer für das kontaktlose Desinfizieren der Hände inkl. Informationstafel / Fuß aus schwarzem Metall - standsicher (10 kg)

disinfection stand for contactless disinfection of hands incl. information board / heavy stand are made of black metal – very stable (10 kg)

estación de desinfección para la desinfección de las manos sin contacto con letrero de información / pie de metal negro - estable (10 kg)

stand de désinfection pour la désinfection des mains sans contact y compris panneau d'information / socle en métal noir - stable (10 kg)

	Ø cm	↑ cm	ltr.
98250	32	163	1,0



Desinfektionsspender „Tischständer“

2 tlg. Set:

- 1 Stk. Desinfektionsspender (no. 98255)
- 1 Stk. Tischständer aus Edelstahl mattiert

Desinfektionsspender „SPRAY“

disinfectant dispenser
dispensador de desinfectante
distributeur de désinfectant



Desinfektionsspender für das kontaktlose Desinfizieren der Hände für die Wandmontage, Inhalt ca. 1 Liter, für 6 Stk. Batterien Typ AA (LR6 / 1,5v)

disinfectant dispenser for contactless disinfection of hands for wall mounting content approx. 1 liter, for 6 batteries type AA (LR6 / 1,5v)

dispensador de desinfectante para la desinfección sin contacto de las manos, para el montaje en la pared, capacidad aproximada de 1 litro, para 6 pilas tipo AA (LR6 / 1,5v)

distributeur de désinfectant pour la désinfection sans contact des mains, pour montage mural, capacité d'environ 1 litre, pour 6 piles de type AA (LR6 / 1,5v)

	cm	↑ cm	ltr.
98255	13,5 x 12,5	26	1,0
98260	13,5 x 16,0	47	1,0



Hygieneschutzwand

sneeze guard
protector higiénico
pare-haleine



Hygieneschutzwand mit Öffnung

sneeze guard with opening
protector higiénico con apertura
pare-haleine avec ouverture

	cm	↑ cm	Öffnung cm / opening cm	✂ mm
98002	75 x 18	48	25 x 12	3



Hygieneschutzwand

sneeze guard
protector higiénico
pare-haleine



Hygieneschutzwand ohne Öffnung

sneeze guard without opening
protector higiénico sin apertura
pare-haleine sans ouverture

	cm	↑ cm	✂ mm
98003	75 x 18	48	3



98040

Hygieneschutzwand

sneeze guard
protector higiénico
pare-haleine



Hygieneschutzwand mit Öffnung

sneeze guard with opening
protector higiénico con apertura
pare-haleine avec ouverture

	cm	↑ cm	Öffnung cm / opening cm	✂ mm	Fuß / base
98040	75 x 16,5	57	26 x 13	5	silber matt/ silver matt
98041	75 x 16,5	57	26 x 13	5	schwarz matt/ black matt



98041

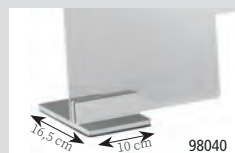

Fuß silber matt
base silver matt



möbelschonende Unterseite
non-scratching undersurface



mit jeweils zwei Schrauben
leicht montierbar
easy mountable with two screws

DRAWER SET



00910
3-teiliges Set
3 pcs. set

50807
2 x Korb, schwarz



15503
GN Buffetständer,
Metall verchromt

15453
GN 2/3 Tablett

00914
Schublade mit
Griff verchromt



00910
3-teiliges Set
3 pcs. set



00911
mit Antirutsch Füßchen
with non-slip feet



00912

Schubladen Set, 3-teilig

drawer set, 3 pcs.
cajonera, set de 3
set tiroir, set de 3



3-teiliges Set:

- 1 Ständer aus Metall schwarz
- 1 Schublade mit Griff schwarz
- 1 Schneidebrett aus geöltem Walnussholz

3 pcs. set:

- 1 stand made of metal black
- 1 drawer with handle black
- 1 oiled walnut wood cutting board

set de 3:

- 1 soporte de metal negra
- 1 cajón con asa negra
- 1 tabla de cortar de madera de nogal engrasada

set de 3:

- 1 support métallique noire
- 1 tiroir avec poignée noire
- 1 planche à découper en bois de noyer huilé

	cm	↑ cm
00910	35,4 x 32,5	20



15506

00912



00911

Anwendungsbeispiele application examples

Einzelteile / parts / piezas / pièces

	cm	↑ cm	
00911	35,4 x 32,5	3,5	Schneidebrett / cutting board
00912	34,0 x 32,0	17,5	Schublade, Griff schwarz / drawer, handle black
00914	34,0 x 32,0	17,5	Schublade, Griff chrom / drawer, handle chrome
15503	35,4 x 32,5	17,6	GN Buffetständer chrom / GN buffet stand chrome
15506	35,4 x 32,5	17,6	GN Buffetständer schwarz / GN buffet stand black



Vitrine / Thekenaufsatz

showcase
vitrina de mostrador
vitrine de comptoir

rutschfest, aus einem Teil gefertigt
antislip, monoblock produced
plástico transparente, fabricado en 1 pieza
transparente, plastique monoblock (injecté)



	cm	↑ cm
11888	63,5 x 25	25



Snackpresenter

snackpresenter
dispensador de bocadillos
présentoir à sandwiches

mit Safrille und Griffmulde, passend für Vitrine 11888
with recessed grip, suitable for showcase 11888
asa moldeada, apto para la vitrina 11888
anse moulée, apte pour vitrine 11888



	cm	↑ cm	
11887	29 x 19	6,5	3 Mulden / 3 compartments 3 compartimentos / 3 compartments
11889	60 x 19	7,5	6 Mulden / 6 compartments 6 compartimentos / 6 compartments

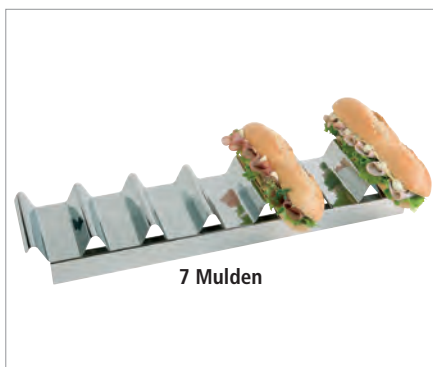

Snackpresenter

snackpresenter
dispensador de bocadillos
présentoir à sandwiches

hochglanzpoliert, mit Griffmulde, für 7 Baguettes
mirror polished finish, with recessed grip, for 7 baguettes
inox pulido brillante, ideal para hasta 7 bocadillos
inox poli brillant, parfait jusque maxi 7 sandwiches



	cm	↑ cm
11891	47,5 x 10,5	6

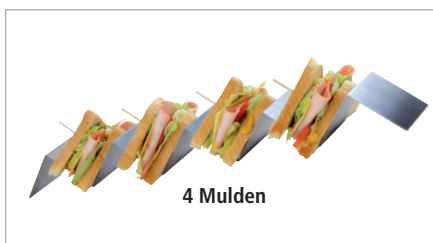

Snackpresenter

snackpresenter
dispensador de bocadillos
présentoir à sandwiches



	cm	↑ cm
11969	56 x 8	5,5

BUFFET GUARD · SHOWCASE



Hygieneschutz
hygienic cover
cubierta higiénica antialiento
pare-haleine



	cm	↑ cm
11556	82 x 42	45



Brötchenspender
roll dispenser
dispensador de panecillos
distributeur de petits pains



hygienisch und einfach zu reinigen, mit Krümelschale
hygienic and easy to clean, with crumb tray
higiénico y fácil de limpiar, con bandeja para migas
hygiénique et facile à laver, avec plat ramasse-miettes

	cm	↑ cm	
11572	32,5 x 27,5	42	für ca. 45 - 50 Brötchen / for approx. 45 - 50 rolls para 45-50 panecillos / pour 45-50 petits pains
11573	32,5 x 27,5	56	für ca. 65 - 70 Brötchen / for approx. 65 - 70 rolls para 65-70 panecillos / pour 65-70 petits pains



Buffetgestell
buffet stand
soporte para buffet
présentoir buffet



3-stufig, geeignet für runde und rechteckige Körbe, platzsparend zusammenklappbar
3-tier, usable for round and rectangular baskets, can be pushed together for place saving
3 alturas, apto para cestas redondas y rectangulares, se puede plegar para ahorrar espacio
3 hauteurs, pour corbeilles rondes ou rectang, la structure s'ouvre ou se ferme pour réduire l'encombrement

	cm	↑ cm
33232	59 x 30,5	59

Tisch- und Buffetkorb, rund „ECONOMIC“ / buffet basket, round / cesta de bufé redonda / corbeille de buffet ronde

	Ø cm	↑ cm	Farbe / Colour
40144	39,0	10,0	



Buffetgestell, 3-teilig
buffet stand, 3 pcs.
expositor de buffet, set de 3
présentoir buffet, set de 3



3-teilig:
1. Fach 40 x 40 cm x H 33 cm;
2. Fach 40 x 37 cm x H 20 cm;
3. Fach 40 x 34 cm x H 9 cm

3 pcs.:
1. 40 x 40 cm x H 33 cm;
2. 40 x 37 cm x H 20 cm;
3. 40 x 34 cm x H 9 cm

	cm	↑ cm	Farbe / Colour	
11607	40 x 40	33		Wenge



Neigungswinkel stufenlos einstellbar
inclination angle continuously adjustable

für 3 versch. Haubengrößen
for 3 different cover sizes

06519 Ø 21 cm
06520 Ø 30 cm
06521 Ø 36 cm



Haubenthalterung „FLEXIBLE“

cover holder
soporte de la cubierta
support de la cloche



Bei dieser Haubenthalterung wird die Haube am Griff in die Vorrichtung gesteckt.
Für APS-Hauben geeignet!

With this cover holder, the cover is inserted into the device by the handle.
Suitable for APS covers!

Con este soporte de campana, la campana se cuelga simplemente por el asa.
¡Para campanas de APS!

Avec ce support, la cloche s'accroche simplement par la poignée.
Pour cloches APS!

	cm	↑ cm
33288	35,5 x 30	39



Anwendungsbeispiele
application examples



24 cm

Haube | cover
Ø 16 cm



Tablett | tray
Ø 18,5 cm

Tablett mit Haube

tray with cover
bandeja con campana
plateau avec cloche



2 teiliges Set:

- 1 Tablett aus geöltem Buchenholz (Ø 18,5 cm, H: 2,5 cm)
- 1 Glas-Haube (Ø 16 cm, H: 22,5 cm)

2 pcs.:

- 1 tray of oiled beech wood (Ø 18,5 cm, H: 2,5 cm)
- 1 glass cover (Ø 16 cm, H: 22,5 cm)

set de 2:

- 1 bandeja de madera de haya (Ø 18,5 cm, H: 2,5 cm)
- 1 campana de cristal (Ø 16 cm, H: 22,5 cm)

set de 2:

- 1 plateau de bois de hêtre (Ø 18,5 cm, H : 2,5 cm)
- 1 couvercle en verre (Ø 16 cm, H : 22,5 cm)

	Ø cm	↑ cm
00830	18,5	24



Präsentationsmöglichkeit
presentation example

MULTI RACK



Multi Rack
multi rack
dispensador en escalera
support multiple



2-stufig, 3-teilig: 1 Gestell matt poliert + 2 Schütten aus transparent gefroretetem Kunststoff, je ca. 1 Liter

2-tier, 3 pcs.: 1 frame satin polished finish + 2 bowls frosted plastic, approx. 1 liter

2 alturas - set de 3: 1 soporte inox mate satinado + 2 bols plástico glaseado, aprox. 1 litro

2 niveaux - set de 3: 1 support satiné + 2 bols plastique mat, approx. 1 litre

	cm	↑ cm
11442	19 x 24	28



Multi Rack
multi rack
dispensador en escalera
support multiple



3-stufig, 4-teilig: 1 Gestell matt poliert + 3 Schütten aus transparent gefroretetem Kunststoff, je ca. 1 Liter

3-tier, 4 pcs.: 1 frame satin polished finish, + 3 bowls frosted plastic, approx. 1 liter

3 alturas, set de 4: 1 estructura inox satinado, + 3 bols de plástico glaseado, aprox. 1 litro

3 niveaux - set de 4: 1 structure inox poli satin, + 3 bols plastique mat, approx. 1 litre

	cm	↑ cm
11444	19 x 24	41



Multi Rack
multi rack
dispensador en escalera
support multiple



3-stufig, 4-teilig: 1 Gestell matt poliert + 1 Schütte aus transparent gefroretetem Kunststoff, ca. 1 Liter + 2 Rutschen aus transparent gefroretetem Kunststoff

3-tier, 4 pcs.: 1 frame satin polished finish + 1 bowl frosted plastic, approx. 1 liter + 2 slides frosted plastic

3 alturas, set de 4: 1 soporte inox satinado + 1 bol de plástico glaseado, aprox, 1 litro + 2 bols con „tobogán“ en plástico glaseado

3 niveaux - set de 4: 1 structure inox poli satin + 1 bol plastique mat approx. 1 litre + 2 bols avec „toboggan“

	cm	↑ cm
11449	19 x 24	41



Multi Rack
multi rack
dispensador en escalera
support multiple



4-stufig, 5-teilig: 1 Gestell matt poliert + 4 Schütten aus transparent gefroretetem Kunststoff, je ca. 1 Liter

4-tier, 5 pcs.: 1 frame satin polished finish + 4 bowls frosted plastic, approx. 1 liter

4 alturas, set de 5: 1 estructura inox satinado + 4 bols de plástico glaseado, aprox. 1 litro

4 niveaux - set de 5: 1 structure inox poli satin, 4 bols plastique mat, approx. 1 litre

	cm	↑ cm
11446	19 x 31	53



Multi Rack
multi rack
dispensador en escalera
support multiple



4-stufig, 5-teilig: 1 Gestell matt poliert + 3 Schütten aus transparent gefrostedem Kunststoff, je ca. 1 Liter + 1 Rutsche aus transparent gefrostedem Kunststoff

4-tier, 5 pcs.: 1 frame satin polished finish + 3 bowls frosted plastic, approx. 1 liter + 1 slide frosted plastic

4 alturas, set de 5 piezas: 1 estructura inox satinado + 3 bols de plástico glaseado, aprox. 1 litro + 1 bol con „tobogán“ de plástico efecto glaseado

4 niveaux - set de 5 éléments: 1 structure inox poli satin + 3 bols plastique mat approx. 1 litre + 1 bol avec „toboggan“

	cm	↑ cm
11451	19 x 31	53



Schütte

Ergänzung für alle Multi-Racks
supplement for all multi racks
suplemento para todos los dispensadores
compléments pour support Multi-Rack



11455	Schütte / canister / bol / bol	
-------	--------------------------------	--



Rutsche

Ergänzung für alle Multi-Racks
supplement for all multi racks
suplemento para todos los dispensadores
compléments pour support Multi-Rack



11456	Rutsche / slide / tobogan / toboggan	
-------	--------------------------------------	--



11466

11467

Besteckständer „TRIPLE TOWER“
cutlery basket
cesta para cubiertos
égouttoir á couverts



4-teiliges Set: 1 Gestell + 3 Köcher

4 pcs.: 1 frame + 3 baskets

set de 4: 1 estructura + 3 cubiertos

set de 4: 1 structure + 3 corbeilles

	cm	↑ cm	Farbe / Colour
11466	18 x 26	43	White
11467	18 x 26	43	Black



variable Nutzungsmöglichkeiten
variable usage possibilities

SERVICE TOWER



Service Tower

service tower
service tower
tour de service



Präsentations- und Spendersystem, bei minimalen Platzbedarf, optimale Wertschöpfung, zum Beispiel im Bereich der Besteckausgabe, Kaffeestationen, Speiseausgaben, Verkaufstheken, etc., Rückwand aus dunklem Holz oder Acryl gefrostet

Presentation and dispenser system, the products find their best creation of value at minimal need of space, for example in the range of coffeestations, food service, counters etc., backplane made of dark wood or acrylic frosted

sistema de presentación y dispensador, con el mínimo espacio conseguirá una excelente presentación de sus productos, por ejemplo en la zona del café, comidas, etc., trasera de madera oscura o de acrílico opaco mate

système de présentation et distribution, très élégant dans un espace minimum, idéal pour la zone café, coin repas, etc., paroi en bois foncé ou en acrylique mat

	cm	↑ cm	Farbe / Colour	
11431	26 x 18	43	■	2x Schütte, tief + 1x Schütte, flach 2 deep ones + 1 flat one 2 rampas hondas + 1 plana / 2 rampas profundes + 1 plates
11432	26 x 18	43	■	3x Schütte, tief / 3 bowls, deep ones 3 rampas hondas / 3 rampas profundes
11422	26 x 18	57,5	■	4x Schütte, tief / 4 bowls, deep ones 4 rampas hondas / 4 rampas profundes

	cm	↑ cm	Farbe / Colour	
11433	26 x 18	43	■	2x Schütte, tief + 1x Schütte, flach / 2 deep ones + 1 flat one / 2 rampas hondas + 1 plana / 2 rampas profundes + 1 plate
11434	26 x 18	43	■	3x Schütte, tief / 3 bowls, deep ones 3 rampas hondas / 3 rampas profundes
11424	26 x 18	57,5	■	4x Schütte, tief / 4 bowls, deep ones 4 rampas hondas / 4 rampas profundes



Basisfuss / base / pie de la base / pied de la base

11435

Rückwand Holz / backplane made of wood / trasera de madera / arrière bois

	cm	
11436	44,5 x 24	für 3 Schütten
11426	60,0 x 24	für 4 Schütten

Rückwand Acryl / backplane made of acrylic / trasera acrílica / arrière acrylique

	cm	
11437	44,5 x 24	für 3 Schütten
11427	60,0 x 24	für 4 Schütten

Schütte, tief / bowl, deep / rampa, honda / rampe profonde

	cm	↑ cm
11438	22 x 14	7 / 5

Schütte, flach / bowl / rampa plana / rampe plate

	cm	↑ cm
11439	22 x 13	3 / 1

BUFFET STAND



33262

33260

33261



33262

Buffetständer „STAR“

buffet stand
soporte para buffet
présentoire buffet



Metall, mit schwarzer Antirutschbeschichtung
metal, with black anti-slide coating
metal, con revestimiento antideslizante negro
métal, avec revêtement antidérapant noir

	↑ cm
33260	8
33261	12
33262	18



33269

Buffetständer „MULTI ROUND“

buffet stand
soporte para buffet
présentoir buffet



Metall, mit schwarzer Antirutschbeschichtung
metal, with black anti-slide coating
metal, con revestimiento antideslizante negro
métal, avec revêtement antidérapant noir

	Ø cm	↑ cm
33269	15,5 / 18	8
33270	15,5 / 18	10
33271	15,5 / 18	18

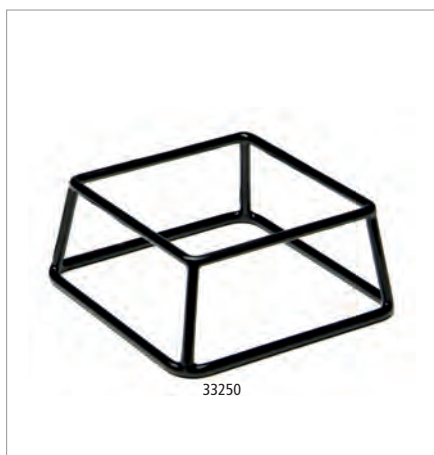

33250

Buffetständer „MULTI“

buffet stand
soporte para buffet
présentoir buffet



Metall, mit schwarzer Antirutschbeschichtung
metal, with black anti-slide coating
metal, con revestimiento antideslizante negro
métal, avec revêtement antidérapant noir

	cm	↑ cm
33249	18 x 18	5
33250	18 x 18	8
33251	18 x 18	10
33252	18 x 18	18

BUFFET STAND



Präsentationsmöglichkeiten /
presentation examples



variable Nutzungsmöglichkeiten /
variable usage possibilities

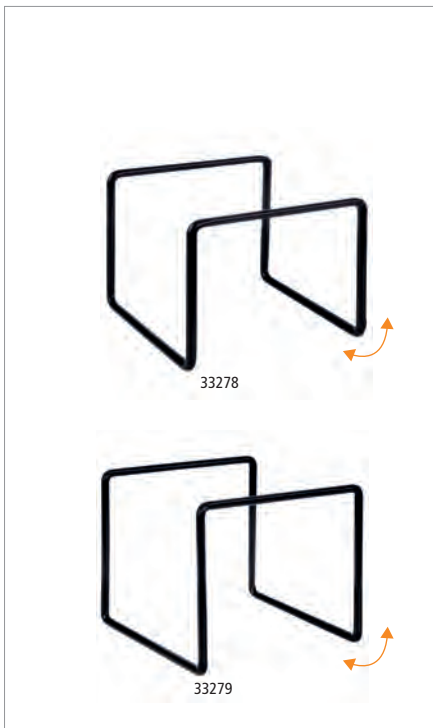

Buffetständer

buffet stand
soporte para buffet
présentoir buffet



Buffetständer aus Metall mit Antirutschbeschichtung

buffet stand made of metal with non-slip coating
soporte para buffet de metal con revestimiento antideslizante
présentoir buffet en métal avec revêtement antidérapant

	cm	↑ cm
33278	11,5 x 11,5	9,0
33279	16,5 x 16,5	14,5

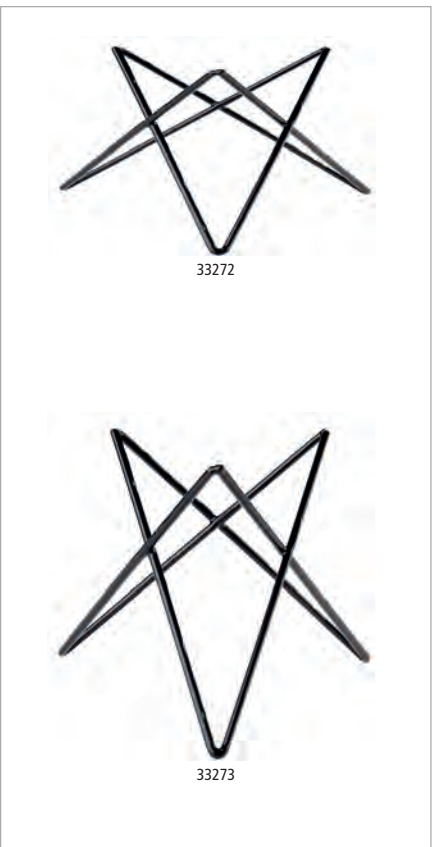

Buffetständer „PRISMA“

buffet stand
soporte para buffet
présentoir buffet



Metall, mit schwarzer Antirutschbeschichtung

metal, with black anti-slide coating
metal, con revestimiento antideslizante negro
métal, avec revêtement antidérapant noir

	Ø cm	↑ cm
33272	20	10,5
33273	20	20,0



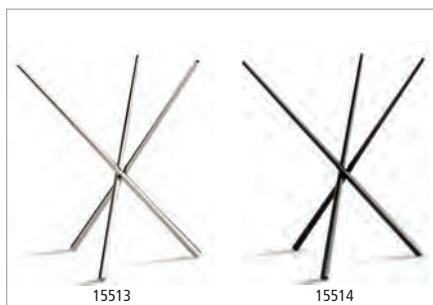

Buffetständer „ASIA PLUS“

buffet stand
soporte para buffet
présentoir buffet



	∅ cm	↑ cm	Farbe / Colour
15513	20,5 / 16,5	20	Light Wood
15514	20,5 / 16,5	20	Dark Wood



Buffetständer „KING“

buffet stand
soporte para buffet
présentoir buffet



kein Verrutschen, Arme und Boden sind mit Antirutschflächen ausgestattet, schwere standsichere Qualität, Fuß dient als Löffelablage

the arms and base are equipped with non-slip surfaces, stable quality, base serves as spoon holder
anti-deslizante: revestimiento antideslizante en las puntas de los brazos y en la base, estable y alta calidad, la base sirve como reposacuchara

antiglisse: revêtement antidérapant sur les extrémités des 3 pieds et sur la base, robuste, stable et bonne qualité, la base sert de support pour les couverts

	∅ cm	↑ cm
03622	15	14
03623	15	21



Buffetständer „WOOD“

buffet stand
soporte para buffet
présentoir buffet



Akazienholz, liegend oder stehend, variable Nutzungsmöglichkeiten

acacia wood, usable by lying or standing, there are many possibilities to use
madera de acacia, se puede usar tumbado o de pie, hay diferentes opciones de utilizar
bois d'accacia, il y a différentes possibilités d'usage

	cm	↑ cm	Farbe / Colour
33280	20 x 20	17,5	Light Wood
33281	20 x 20	17,5	Dark Wood



liegend oder stehend, variable Nutzungsmöglichkeiten
vertically or horizontally, there are variable usage possibilities



Buffetständer

buffet stand
expositor de buffet
présentoir buffet



Akazienholz
acacia wood
madera de acacia
bois d'accacia

	∅ cm	↑ cm
33255	15	10
33256	25	15

PROFI LINE



GN Edelstahl-Tablett „PROFI LINE“

GN tray
GN bandeja
GN plat empilable système catering



	cm	↑ cm	GN	
11100	53,0 x 32,5	1,5	1/1	mit glattem Rand / without decor-edge sin borde decorado / bords lisses
12100	32,5 x 26,5	1,5	1/2	mit glattem Rand / without decor-edge sin borde decorado / bords lisses
11000	53,0 x 32,5	1,5	1/1	mit Dekor-Rand / with decor-edge con borde decorado / bords avec relief
12000	32,5 x 26,5	1,5	1/2	mit Dekor-Rand / with decor-edge con borde decorado / bords avec relief
11110	53,0 x 32,5	1,0	1/1	glatter schmaler Rand / smooth narrow edge / borde estrecho liso / bord étroit lisse



Fleisch- und Gemüseplatte „PROFI LINE“

tray
fuente de servicio
plat de service

Dekorrand hochglanzpoliert
decor edge mirror polished finish
borde decorado pulido efecto espejo
contour relief avec effet miroir



	Ø cm	↑ cm
11032	32	2,5
11038	38	2,5
11048	48	2,5



GN Edelstahl-Behälter „PROFI LINE“

GN pan
GN cubeta
GN bac



	cm	↑ cm	GN	litr.
11020	53,0 x 32,5	2,0	1/1	1,7
11040	53,0 x 32,5	4,0	1/1	3,4
11065	53,0 x 32,5	6,5	1/1	7,0
12065	32,5 x 26,5	6,5	1/2	3,3



Distanzstücke erhöhen die Nutzhöhe auf 4 cm

GN 1/1 System-Tablett „PROFI LINE“

GN 1/1 tray
GN 1/1 bandeja
GN 1/1 plateau



Dekorrand hochglanzpoliert, massive Griffe verchromt, inkl. fest verschraubten Distanzstücken, Nutzhöhe 4 cm
decor edge mirror polished finish, chrome plated handles, incl. mounted 4 cm distance pillars
borde decorado pulido brillante, asas cromadas, incl. distanciadores atornillados, con profundidad efectiva de 4 cm
bord avec reliefs poli miroir, poignées chromées, incl. distance bien fixée avec hauteur utile de 4 cm

	cm	GN
11300	53 x 32,5	1/1



Distanzstücke erhöhen die Nutzhöhe auf 4 cm

GN 1/1 System-Tablett „PROFI LINE“

GN 1/1 tray
GN 1/1 bandeja
GN 1/1 plateau



Rand hochglanzpoliert, massive Bügelgriffe vergoldet, inkl. fest verschraubten Distanzstücken, Nutzhöhe 4 cm
mirror polished finish edge, gold plated handles, stackable approx. 4 cm
borde pulido brillante, asas doradas, incl. distanciadores atornillados, con profundidad efectiva de 4 cm
bord poli miroir, poignées dorées, incl. distance bien fixée avec hauteur utile de 4 cm

	cm	GN
11290	53 x 32,5	1/1



11150
mit verchromten Griffen

11155
mit vergoldeten Griffen

GN 1/1 System-Tablett „BUFFET-STAR“

GN 1/1 tray
GN 1/1 bandeja
GN 1/1 plateau



Rand hochglanzpoliert, inkl. fest verschraubten Griffen inkl. Distanzstücken, Nutzhöhe 4 cm
mirror polished finish edge, incl. screwed handles incl. distance pillars, 4 cm distance
borde pulido brillante, incl. asas atornillables, incl. distanciadores con profundidad efectiva de 4 cm
bord poli miroir, incl. poignées à visser, incl. distance avec hauteur utile de 4 cm

	cm	GN	
11150	53 x 32,5	1/1	mit verchromten Griffen / with chrome plated handles / con asas cromadas / avec poignées chromées
11155	53 x 32,5	1/1	mit vergoldeten Griffen / with gold plated handles / con asas doradas / avec poignées dorées

TRAY · BOARD



System-Tablett „BUFFET-STAR“

system tray
bandeja del sistema
plat empilable système catering



Rand hochglanzpoliert, inkl. fest verschraubten Griffen inkl. Distanzstücken, Nutzhöhe 4 cm
mirror polished finish edge, incl. screwed handles incl. distance pillars, 4 cm distance
borde pulido efecto espejo, incluye asas atornillables, distanciadores a 4 cm
contour effet miroir, poignées à visser, distance approx. 4 cm

	Ø cm	
11160	48	mit verchromten Griffen / with chrome handles
11165	48	mit vergoldeten Griffen / gold plated handles

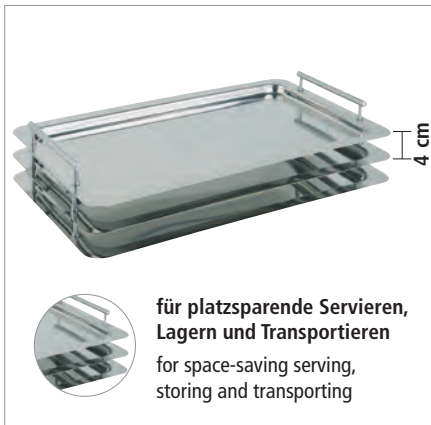

GN 1/1 System-Tablett „CLASSIC“

GN tray
GN bandeja
GN plat empilable système catering



Rand hochglanzpoliert, mit fest verschraubten Griffen inkl. Distanzstücken, Nutzhöhe 4 cm
mirror polished finish edge, incl. screwed handles incl. distance pillars, 4 cm distance
borde pulido efecto espejo, incluye asas atornillables, distanciadores a 4 cm
contour effet miroir, poignées à visser, distance approx. 4 cm

	cm	GN
11295	53 x 32,5	1/1



Tablett „SWING“

tray
bandeja
plateau



Rand matt poliert, innen hochglanzpoliert
satin polished finish edge, inside mirror polished finish
borde pulido efecto satinado, interior pulido efecto espejo
contour effet mat, intérieur poli miroir

	cm	↑ cm	GN
01415	28,5 x 20,0	1	
01416	32,5 x 32,5	1	
01420	53,0 x 32,5	1	1/1



Tablett „SUNDAY“

tray
bandeja
plateau



hochglanzpoliert
mirror polished finish
acabado espejo pulido
effet brillant

	cm	↑ cm	GN
11210	32,5 x 26,5	2	1/2
11220	53,0 x 32,5	2	1/1



11195
2-tlg. Set Tablett + Haube

stapel- und
fixierbar

GN 1/1 Buffet-Set „CATERER“

GN 1/1 buffet set
GN 1/1 set de bufé
GN 1/1 set catering: plateau + cloche



2-teilig: Tablett + Haube, Tablett fixiert sich auf der Haube - kein Rutschen möglich
2 pcs. set: tray + cover, tray fixes itself on the cover and can not slip off
set de 2: bandeja + tapa, la bandeja encaja encima de la tapa para que no se deslice
set de 2: plateau GN 1/1 réf. + cloche spéciale empilement stable

	cm	↑ cm	GN
11195	53 x 32,5	10,5	1/1



11302
GN 1/1, 2-tlg. Set Tablett + Haube

GN 1/1 Buffet-Set „HOCHSTAPLER“

GN 1/1 buffet set
GN 1/1 set de bufé
GN 1/1 kit catering plateau + cloche



2-teilig: Tablett + Haube, Tablett fixiert sich auf der Haube - kein Rutschen möglich
2 pcs. set: tray + cover, tray fixes itself on the cover and can not slip off
set de 2: bandeja + tapa, la bandeja encaja encima de la tapa para que no se deslice
set de 2: plateau GN 1/1 réf. + cloche spéciale empilement stable

	cm	↑ cm	GN
11302	53 x 32,5	10,5	1/1



11305
Haube / cover

11300
Tablett / tray

Haube für stapelbare Tablett:
11300, 11290 oder 11295

GN 1/1 Haube „HOCHSTAPLER“

GN 1/1 cover
GN 1/1 campana
GN 1/1 cloche



glasklarer Kunststoff, Tablett fixiert sich auf der Haube - kein Rutschen möglich, nahezu bruchfest
clear plastic, tray fixes itself on the cover and can not slip off, nearly unbreakable
plástico transparente, la bandeja se fija a la tapa para que no se deslice, muy resistente a la rotura
en plastique transparen, le plat se fixe sur le dessous de la cloche pour ne pas glisser, très résistant à la casse

	cm	↑ cm	fits to	GN
11305	53 x 32,5	9	11300, 11290, 11295	1/1



GN Abdeckhaube

GN cover
GN cubierta
GN cloche



	cm	↑ cm	✦ mm	GN
11041	32,5 x 26,5	9,5	3	1/2
11042	53,0 x 32,5	9,5	3	1/1
11043	32,5 x 17,6	10,5	3	1/3
11044	53,0 x 16,2	10,5	3	2/4

TRAY · BOARD



Tablett „SCHÖNER ESSEN“

tray
bandeja
plateau



	cm	GN
00383	35,0 x 24,0	
00382	42,0 x 31,0	
00381	50,0 x 36,0	
00384	63,5 x 44,5	
00385	60,0 x 40,0	
00388	53,0 x 32,5	1/1

	cm	
03824	42,0 x 31,0	leichte Ausführung 0,5 mm / extra light model 0,5 mm modelo extraligero 0,5 mm / qualité légère, ép. 0,5 mm



Tablett „SCHÖNER ESSEN“

tray
bandeja
plateau



mit Dekorrand, Griffe Zinkdruckguss verchromt, genietet
with decor edge, handles zinc alloy chrome plated, riveted
borde decorado, asas fundición con zinc
bord décor, poignées en fonte zinguée

	cm
00082	52 x 31,0
00081	60 x 36,0
00084	75 x 44,5



Tablett „SCHÖNER ESSEN“

tray
bandeja
plateau



	cm	
00087	38 x 23	rechteckig, abgerundet / rectangular, rounded edge rectangular / rectangulaire



Edelstahl-Schale

bowl
bandeja
corbeille



ingerollter Rand
rolled edge
borde redondeado
bord roulé

	cm	↑ cm
40110	26,5 x 18,5	4,0
40115	31,0 x 21,0	4,5



00075

Tablett „SCHÖNER ESSEN“

tray
bandeja
plateau



	Ø cm
00075	31
00085	35



Tablett mit Haube „SCHÖNER ESSEN“

tray with cover
bandeja con cubierta
plateau avec cloche



	cm	↑ cm
38202	42 x 31	8

Haube / cover / campana / cloche

	cm	↑ cm
08201	36,5 x 26,0	7,5



Tablett

tray
bandeja
plateau



mit gebördeltem, polierten Rand
rolled and mirror polished edge
borde redondeado acabado efecto espejo
bord rond, effet miroir

	Ø cm	↑ cm
01336	35	3



01336

74207

Buffetständer

buffet stand
soporte buffet
support buffet



	Ø cm	↑ cm	fits to
74207	20 - 25	19	01336



Ø 19 cm - Ø 28 cm - Ø 40 cm

60270

Servierpfanne

pan
fuente para la mesa
plat pour la table



mit vergoldeten Edelstahl-Griffen, 1 mm dick
with gold plated handles, 1 mm thickness
grosor 1 mm., asas doradas
épaisseur 1 mm, poignées dorées

	cm	↑ cm	ltr.
61190	19	3,5	0,7
61280	28	4,0	2,0
61400	40	5,0	4,5
60270	26,5 x 19,5	3	0,8
60310	31,0 x 21,5	3	1,2

TRAY · BOARD



Tablett „FINESSE“

tray
bandeja
plateau



	cm
01314	30 x 24
01313	35 x 24
01317	39 x 26
01312	42 x 31
01318	48 x 30
01311	50 x 38
01310	58 x 42
01309	68 x 48



Tablett „FINESSE“

tray
bandeja
plateau



	Ø cm
01332	32,0
01335	35,0
01338	38,0
01348	48,0
01349	48,5
01358	58,0



Tablett „FINESSE“

tray
bandeja
plateau



	cm
01322	42 x 30
01323	50 x 36
01324	60 x 41
01325	70 x 46



Tablett „FINESSE“

tray
bandeja
plateau



verchromte Messing-Griffe
chrome plated brass handles
asas plateadas de latón
poignées en laiton chromées

	Ø cm
01738	38
01748	48



Tablett „FINESSE“

tray
bandeja
plateau

verchromte Messing-Griffe
chrome plated brass handles
asas de latón cromadas
poignées en laiton chromées



	cm	
01712	44 x 31	
01711	52 x 38	
01710	60 x 42	
01709	70 x 48	



Tablett mit Haube „FINESSE“

tray with cover
bandeja con campana
plateau avec cloche



	cm		↑ cm
13122	42 x 31		8,5



Tablett mit Haube „FINESSE“

tray with cover
bandeja con campana
plateau avec cloche



	Ø cm	↑ cm
13622	22	9,5



Tablett mit Haube „FINESSE“

tray with cover
bandeja con cubierta
plateau avec cloche



	Ø cm	↑ cm	Ø cm Hauben / cover
13382	38	12	30
13385	38	13	33



Edelstahltablett

tray
bandeja
plateau



	cm		↑ cm
09010	43,5 x 32,5		1,5

Rolltophaube „FOCUS“ / rolltop cover / campana abatible / cloche basculante

	cm		↑ cm
09013	44 x 33,5		17



Tablett mit Haube, 2-teilig

tray with cover, 2 pcs.
bandeja con cubierta, set de 2
plateau avec cloche, set de 2

Tablett aus Edelstahl, hochglanzpoliert
stainless steel tray, mirror polished finish
bandeja de acero inoxidable, acabado brillante
plateau en acier inoxydable, brillant



	Ø cm	↑ cm
00827	27	12,5

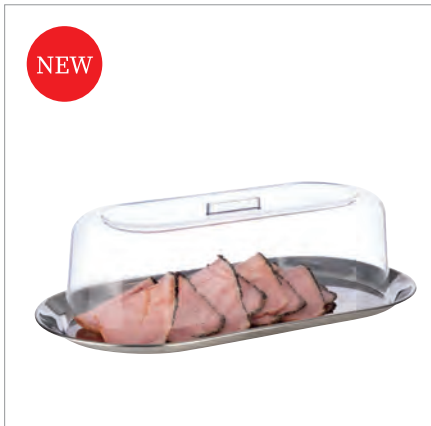

Tablett mit Haube, 2-teilig

tray with cover, 2 pcs.
bandeja con cubierta, set de 2
plateau avec cloche, set de 2

Tablett aus Edelstahl, hochglanzpoliert
stainless steel tray, mirror polished finish
bandeja de acero inoxidable, acabado brillante
plateau en acier inoxydable, brillant



	cm	↑ cm
00828	30 x 15,5	10,5

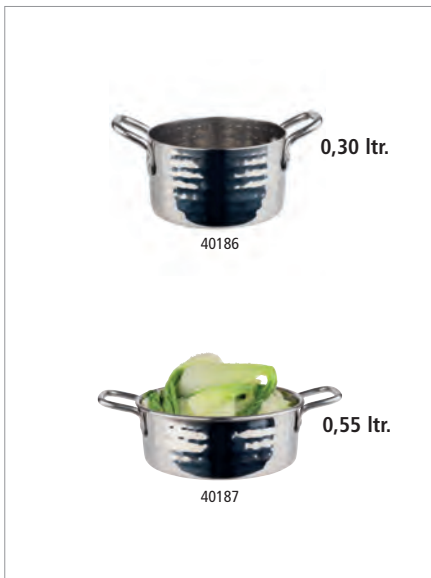

Serviertöpfchen

small serving pot
olla pequeña de servir
marmite petite de servir

gehämmerte Oberfläche
hammered surface
superficie martillada
surface martelée



	Ø cm	↑ cm	ltr.	Griff / handle cm
40186	9,5	5,5	0,30	2,5
40187	13,5	5,0	0,55	3,0
40188	15,5	5,0	0,75	3,0



Kaviarkühler

caviar cooler
enfriador de caviar
rafraîchisseur de caviar

4-teilig: 1 Edelstahlschale, 1 Halter, 1 Glashalm, 1 Edelstahldeckel

4 pcs.: 1 stainless steel bowl, 1 holder, 1 glass bowl Ø 10 cm, 1 stainless steel cover

set de 4: 1 bol de acero inoxidable, 1 soporte, 1 bol de vidrio Ø 10 cm, 1 tapa de acero inoxidable

set de 4: 1 bol en acier inox, 1 support, 1 bol en verre Ø 10 cm, couvercle en acierinox



	Ø cm	↑ cm
01699	18	12



Tablett „ELEGANCE“

tray
bandeja
plateau



	cm
02310	41 x 26
02311	48 x 30
02312	60 x 37



Tablett mit Haube „ELEGANCE“

tray with cover
bandeja con cubierta
plateau avec cloche



	cm	↑ cm
23642	35 x 19	10



Serviertablett mit Haube

tray
bandeja
plateau



	cm	↑ cm
00064	33 x 17	10
00067	25 x 19	7

Haube für 00064 / cover for 00064 / campana para 00064 / cloche pour 00064

06401

Haube für 00067 / cover for 00067 / campana para 00067 / cloche pour 00067

06701

TRAY · BOARD



Tortenplatte mit Haube

cake plate with cover
bandeja tarta con campana
plat à tarte avec cloche



	Ø cm	↑ cm	
00065	30	11	mit 1 Haube / with 1 cover
00652	30	7 + 11	mit 2 Hauben / with 2 cover



Tortenplatte „BAROCK“

cake plate
bandeja tartas
plat à gâteau



2-teilig: Tortenplatte mit Barock-Rand + Haube (extra stabil)
2 pcs.: cake plate with decor edge „Barok“ + cover (extra robust)
set de 2: porta tartas, borde decor „Barok“ + campana (extra fuerte)
set de 2: plateau bord décor „Barok“ + cloche ultra-résistante

	Ø cm	↑ cm
06503	32	10

Frischhalte-Haube / cover / campana / cloche

	Ø cm	↑ cm
06510	30	11,5



Käseglocken-Set „BRAZIL“

rolltop set
set rolltop
set cloche á fromage



3-teilig: Tablett + Holzschneidebrett + Rolltophaube glasklar, rutschfeste Haubenfixierung
3 pcs. set: tray + wooden board + rolltop cover, cover non-slip fixed
set de 3: bandeja + tablero de madera + campana abatible, fijación antideslizante
set de 3: plateau + planche à découper + cloche abattante, fixation antiglisse

	Ø cm	↑ cm
09085	45	24



Rolltop-Set

rolltop set
set rolltop
set cloche à fromage



2-teilig: Tablett + Rolltophaube glasklar, rutschfeste Haubenfixierung, klappbar
2 pcs.: tray + rolltop cover, cover non-slip fixed, mountable
set de 2: bandeja + campana abatible fijación antideslizante, montable
set de 2: plateau + cloche abattante, fixation antiglisse, montable

	Ø cm	↑ cm
09080	38	24
09099	50	28



Rolltop-Set

rolltop set
set rolltop
set rolltop



2-teilig: Schneidbrett marmoriert + Rolltophaube glasklar,
rutschfeste Haubenfixierung, klappbar

2 pcs.: plastic board + rolltop cover, cover non-slip fixed, mountable
set de 2: tablero de plástico + tapa abatible, tapa antideslizante, montable
set de 2: planche à découper + cloche abattante, fixation antiglisse, montable

	Ø cm	↑ cm
09081	38	24



Rolltop-Set, 3-teilig

rolltop set, 3 pcs.
rolltop, set de 3
rolltop, set de 3



1 Edelstahltablett Ø 38 cm + 1 Naturschieferplatte Ø 33 cm + 1 Rolltophaube Ø 38 cm

1 stainless tray Ø 38 cm + 1 natural slate tray Ø 33 cm + 1 rolltop cover Ø 38 cm
1 bandeja de acero inoxidable Ø 38 cm + 1 bandeja de pizarra natural Ø 33 cm + 1 tapa abatible Ø 38 cm
1 plat inox 38 cm + 1 plat ardoise naturelle 33 cm + 1 cloche 38 cm

	Ø cm	↑ cm
01000	38	24



Buffet-Set

buffet set
set de bufé
présentoir pour le buffet



2-teilig: Platte + Rolltophaube, schneidfeste und porenfreie Oberfläche, rutschfeste Haubenfixierung, Platte mit rutschfesten Füßen

2 pcs.: glass board + rolltop cover, scratch-resistant surface, cover non-slip fixed, non-slip feet
set de 2 piezas: bandeja vidrio redonda + campana abatible, fijación antideslizante, pies antideslizantes

set de 2 pièces: plateau verre rond + cloche abattante, fixation antiglisse et pieds antidérapants

	Ø cm	↑ cm
00978	38	23

Rolltop-Haube mit Löchern / rolltop cover / campana abatible / cloche basculante

	Ø cm	↑ cm
18394	38	20

Glasplatte / glass plate / bandeja de vidrio / plateau verre

	Ø cm	↑ cm
00972	38	3



Tablett mit Haube

tray with cover
bandeja con campana
plateau avec cloche

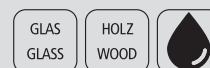

2 teiliges Set:

- 1 Tablett aus geöltem Buchenholz (Ø 18,5 cm, H: 2,5 cm)
- 1 Glas-Haube (Ø 16 cm, H: 22,5 cm)

2 pcs.:

- 1 tray of oiled beech wood (Ø 18,5 cm, H: 2,5 cm)
- 1 glass cover (Ø 16 cm, H: 22,5 cm)

	Ø cm	↑ cm
00830	18,5	24

TRAY · BOARD



NEW

Tablett mit Haube, 2 teilig

tray with cover, 2 pcs.
bandeja con cubierta, set de 2
plateau avec cloche, set de 2

Tablett aus Bambus, ölimprägniert und feuchtigkeitsabweisend
bamboo tray, oil-impregnated and moisture-repellent
bandeja de bambú, impregnada de aceite y repelente a la humedad
plateau en bambou, imprégné d'huile et résistant à l'humidité



cm ↑ cm

00820 24 x 18,5 8



NEW

Kastenkuchen-Größe
box-cake size

Tablett mit Haube, 2 teilig

tray with cover, 2 pcs.
bandeja con cubierta, set de 2
plateau avec cloche, set de 2

Tablett aus Bambus, ölimprägniert und feuchtigkeitsabweisend
bamboo tray, oil-impregnated and moisture-repellent
bandeja de bambú, impregnada de aceite y repelente a la humedad
plateau en bambou, imprégné d'huile et résistant à l'humidité



cm ↑ cm

00821 32 x 16,5 11



NEW

Tablett mit Haube, 2 teilig

tray with cover, 2 pcs.
bandeja con cubierta, set de 2
plateau avec cloche, set de 2

Tablett aus Bambus, ölimprägniert und feuchtigkeitsabweisend
bamboo tray, oil-impregnated and moisture-repellent
bandeja de bambú, impregnada de aceite y repelente a la humedad
plateau en bambou, imprégné d'huile et résistant à l'humidité



Ø cm ↑ cm

00822 20,5 10



NEW

Tablett mit Haube, 2-teilig

tray with cover, 2 pcs.
bandeja con cubierta, set de 2
plateau avec cloche, set de 2

Tablett aus Holz, ölimprägniert und feuchtigkeitsabweisend, Gugelhupf Größe
wooden tray, oil-impregnated and moisture-repellent, Gugelhupf size
bandeja de madera, impregnada de aceite y repelente a la humedad, tamaño Gugelhupf
plateau en bois, imprégné d'huile et résistant à l'humidité, taille Gugelhupf



Ø cm ↑ cm

00825 25 13,5



NEW

Tablett mit Haube, 2-teilig

tray with cover, 2 pcs.
bandeja con cubierta, set de 2
plateau avec cloche, set de 2

Tablett aus Holz, ölimprägniert und feuchtigkeitsabweisend
wooden tray, oil-impregnated and moisture-repellent
bandeja de madera, impregnada de aceite y repelente a la humedad
plateau en bois, imprégné d'huile et résistant à l'humidité



cm ↑ cm

00826 28 x 14 11,5



00393 oder / or 00396
96 x

00391 oder / or 00398
96 x

00392 oder / or 00399
96 x

00394 oder / or 00395
96 x

Warenträger

display
expositor
présentoir

für Partyplatten

- platzsparende flexible Präsentation durch geringe Abmessungen
- als Zweitplatzierung für Ihre zusätzlichen Umsätze
- in weiß lieferbar

for partytrays- space saving presentation- small size- available in white

para bandejas Party, ocupa poco espacio, disponible en blanco

pour plateaux Party, occupe très peu d'espace, disponible en blanc

	cm	↑ cm
00397	55 x 65	190



hot price

Ø 35 cm



00396 round



00398 oval



GN 1/1 00395

Partyplatte „CLASSIC“

partytray
bandeja party
plateau party



Rand eingerollt

rolled edge
con filos en relieve
bord rond

	cm	VE / unit	GN	
00396	Ø 35	48	-	round
00398	46,0 x 34,0	48	-	oval
00399	41,0 x 31,0	48	-	
00389	35,4 x 32,5	48	2/3	
00395	53,0 x 32,5	36	1/1	



hot price

Ø 35 cm



00393 round



00391 oval



00392

Partyplatte „CLASSIC“

partytray
bandeja party
plateau party



Rand eingerollt

rolled edge
con filos en relieve
bord rond

	cm	VE / unit	GN	
00393	Ø 35	48	-	round
00391	46 x 34	48	-	oval

	cm	VE / unit	GN	
00392	41 x 31	48	-	
00394	53 x 32,5	36	1/1	

TRAY · BOARD



Tablett

tray
bandeja
plateau



Tablett aus Edelstahl, hochglanzpoliert, stabiler Rand eingerollt
stainless steel tray, mirror polished finish, stable edge rolled in
bandeja de acero inoxidable, pulido efecto espejo, borde estable enrollado
plateau en acier inoxydable, effet brillant, bord stable enrollé

	Ø cm	↑ cm
30148	27	1,5



Tablett

tray
bandeja
plateau



Tablett aus Edelstahl, hochglanzpoliert, stabiler Rand eingerollt
stainless steel tray, mirror polished finish, stable edge rolled in
bandeja de acero inoxidable, pulido efecto espejo, borde estable enrollado
plateau en acier inoxydable, effet brillant, bord stable enrollé

	cm	↑ cm
30149	30 x 15,5	1,5



Präsentationsmöglichkeit
presentation example



Serviertablett „KAFFEEHAUS“

tray
bandeja
plateau



matt poliert, oval, Rand eingerollt
satin polished finish, oval, rolled edge
pulido acabado efecto satinado, oval, borde redondeado
effet satin, ovale, bord rond

	cm	↑ cm	
30111	20,0 x 14,5	0,5	für Zucker und Sahne / for sugar and cream
30112	26,5 x 19,5	0,5	für eine Tasse / for one cup
30113	29,0 x 22,0	0,5	für zwei Tassen / for two cups
30123	23,0 x 17,5	0,5	Eisdielen-Größe / icecream pralor size



Serviertablett „KAFFEEHAUS“

tray
bandeja
plateau



hochglanzpoliert, oval, Rand eingerollt
mirror polished finish, oval, rolled edge
pulido efecto espejo, ovalado, borde redondeado
effet brillant, ovale, bord rond

	cm	↑ cm	
30115	20,0 x 14,5	0,5	für Zucker und Sahne / for sugar and cream para azúcar y crema / pour le sucre et la crème
30116	26,5 x 19,5	0,5	für eine Tasse / for one cup para una taza / pour une tasse
30117	29,0 x 22,0	0,5	für zwei Tassen / for two cups para dos tazas / pour deux tasses



Serviertablett „KAFFEEHAUS“

tray
bandeja
plateau



matt poliert, Rand ingerollt
satin polished finish, rolled edge
acabado pulido satinado, borde redondeado
effet satin mat, bord rond

	cm	↑ cm
30118	21,5 x 13	1,5
30119	23,0 x 23	1,5
30120	20,0 x 11	1,5
30121	29,0 x 20	1,5



30119



mattiert
satin polished finish

Serviertablett „KAFFEEHAUS“

tray
bandeja
plateau



	cm	↑ cm	
30126	25,5 x 19,5	2	mattiert / satin polished finish acabado efecto satinado / fini mat effet satin



84253

Serviertablett „KAFFEEHAUS“

tray
bandeja
plateau



	cm	↑ cm	Farbe / Colour
84251	26,0 x 20,0	1,5	■
84253	28,5 x 21,5	1,5	■



hot price

Serviertablett „KAFFEEHAUS“

tray
bandeja
plateau



Innenfläche ziseliert, Rand ingerollt
rolled edge
borde redondeado, superficie decor relieve
bord rond, surface entièrement ciselée

	cm	pcs.
30114	30 x 22	48

TRAY • BOARD



Tablett „VINTAGE“

tray
bandeja
plateau



Antik-Edelstahl-Look

stainless steel antique look
acero estilo antiguo
acier style antique

	cm	↑ cm
30130	26,0 x 13,5	1,5
30131	34,0 x 18,0	1,5
30132	38,0 x 26,5	1,5
30133	25,5 x 16,0	3,0

passende Schälchen / fitting bowls / cuencos adecuados / bols appropriés



	Ø cm	↑ cm	ltr.
40655	7,5	5,5	0,17
40656	7,5	10,0	0,35



Servierbeispiel
presentation example

Tablett „TREND“

baking sheet
bandeja
plateau



ein Backblech wird zum Serviertablett

a baking sheet which becomes a serving tray
una bandeja de hornear que se convierte en una bandeja de servir
un moule qui devient un plateau de service

	cm	↑ cm
13380	32 x 21,5	2



GN Tablett „FRAMES“

GN tray
GN bandeja
GN plateau



	cm	↑ cm	GN
82355	53,0 x 32,5	2	1/1
82356	32,5 x 26,5	2	1/2
82357	32,5 x 17,6	2	1/3



GN Tablett

GN tray
GN bandeja
GN plateau



	cm	↑ cm	GN
82201	53,0 x 32,5	2,5	1/1
82202	32,5 x 26,5	2,5	1/2
82203	32,5 x 17,6	2,5	1/3
82204	53,0 x 16,2	2,5	2/4
82205	35,4 x 32,5	2,5	2/3



GN Tablett „FRAMES“

GN tray
GN bandeja
GN plateau



	cm	↑ cm	GN
84046	53,0 x 32,5	2	1/1
84047	32,5 x 26,5	2	1/2
84048	32,5 x 17,6	2	1/3



GN Naturschieferplatten

GN natural slate tray
GN bandeja de pizarra natural
GN plat ardoise naturelle



hervorragende Kältespeicherung durch Naturschiefer, die Kanten der Platten sind gebrochen und nicht gesägt
excellent coldness store, food safe, waterproof
excelente conservador del frío, para reforzar la estética natural, los bordes ofrecen un canto irregular
excellent maintien du froid, les bords sont volontairement cassés pour renforcer l'esthétique naturelle

	cm	✧ mm	GN
00990	53,0 x 32,5	6 - 9	1/1
00991	32,5 x 26,5	6 - 9	1/2
00992	32,5 x 17,6	6 - 9	1/3
00993	26,5 x 16,2	6 - 9	1/4
00973	53,0 x 16,2	6 - 9	2/4



Naturschieferplatte
natural slate tray
bandeja de pizarra natural
plat ardoise naturelle



	cm	✧ mm
00996	45 x 30	6 - 9



Naturschieferplatte
natural slate tray
bandeja de pizarra natural
plat ardoise naturelle



	cm	✧ mm
00994	25 x 25	6 - 9
00995	30 x 30	6 - 9

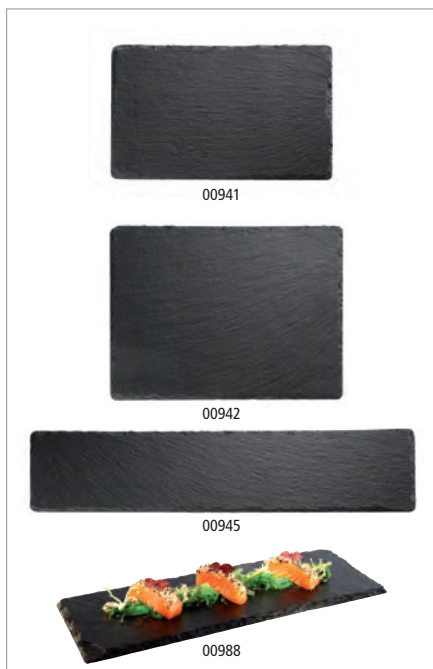

Naturschieferplatte
 natural slate
 bandeja de pizarra natural
 plateau ardoise naturelle



	cm	* mm
00941	24,0 x 15,0	6 - 9
00942	26,5 x 20,5	6 - 9
00945	47,0 x 10,0	6 - 9
00988	30,0 x 12,0	6 - 9

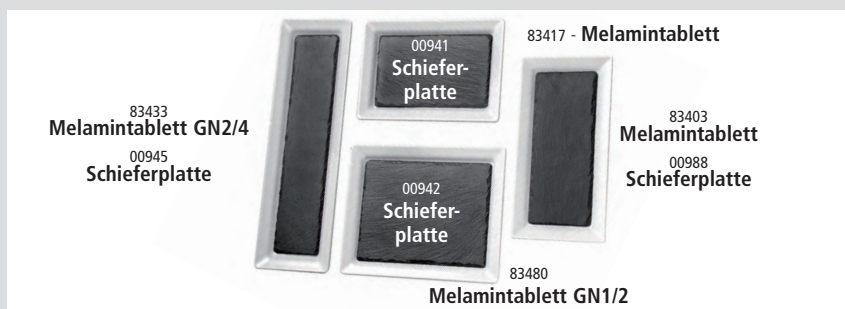

GN 1/1 Naturschieferplatte „HOCHSTAPLER“
 GN 1/1 natural slate tray
 GN 1/1 bandeja de pizarra natural
 GN 1/1 plat ardoise naturelle



	cm	↑ cm	* mm
00966	53 x 32,5	6	6 - 9



Griffe verchromt, 4 cm Nutzhöhe
 chrome plate handles, 4 cm distance



Naturschieferplatte
 natural slate tray
 bandeja pizarra natural
 plat ardoise naturelle



mit Absatz Ø 6 cm
 with hole Ø 6 cm
 con agujero Ø 6 cm
 avec trou Ø 6,0 cm

	cm	* mm
00986	25 x 12	6 - 9

passende Gläser:
 82310, 82312, 82314, 82316



Naturschieferplatte
 natural slate tray
 bandeja pizarra natural
 plat ardoise naturelle



mit 3 Absätzen, Ø 6 cm
 with 3 holes, Ø 6 cm
 con 3 agujeros, Ø 6 cm
 avec 3 trous, Ø 6 cm

	cm	* mm
00987	28 x 10	6 - 9

passende Gläser:
 82310, 82312, 82314, 82316

TRAY · BOARD



Naturschieferplatte „STARTER“

natural slate tray
bandeja de pizarra natural
plat ardoise naturelle carré



	cm	✱ mm
00937	20 x 10	6 - 9



Naturschieferplatte / Untersetzer

natural slate tray
bandeja de pizarra natural
plateau ardoise naturelle



mit 2 Absätzen Ø 6 cm
with 2 holes Ø 6 cm
con 2 agujeros Ø 6 cm
avec 2 trous Ø 6 cm

	cm	✱ mm
00971	15 x 8	6 - 9



Naturschieferplatte

natural slate tray
bandeja de pizarra natural
plat ardoise naturelle



	Ø cm	✱ mm
00968	22	6 - 9
00969	28	6 - 9
00998	33	6 - 9
00999	38	6 - 9



Tortenplatte / Servierplatte

drehbar
cake stand
soporte para pastel
présentoir à gâteaux



	Ø cm	↑ cm	✱ mm
00975	32	2,5	6 - 9



Rolltop-Set, 3-teilig

rolltop set, 3 pcs.
rolltop, set de 3
rolltop, set de 3



1 Edelstahltablett Ø 38 cm + 1 Naturschieferplatte Ø 33 cm + 1 Rolltophaube Ø 38 cm

1 stainless tray Ø 38 cm + 1 natural slate tray Ø 33 cm + 1 rolltop cover Ø 38 cm

1 bandeja de acero inoxidable Ø 38 cm + 1 bandeja de pizarra natural Ø 33 cm + 1 tapa abatible Ø 38 cm

1 plat inox 38 cm + 1 plat ardoise naturelle 33 cm + 1 cloche 38 cm

	Ø cm	↑ cm
01000	38	24



3-stufige Etagère

3-tier tray
bandeja con tres alturas
étagère carré 3 hauteurs

Naturschiefer, Akazienholz
natural slate tray, wood akazie
bandeja de pizarra natural, madera de acacia
plateau ardoise naturelle, bois d'acacia



	∅ cm	↑ cm	* mm
00960	30 / 25 / 20	34	6 - 9



2-stufige Etagère

2-tier tray
bandeja dos alturas
étagère carré 2 hauteurs

Naturschiefer
natural slate tray
bandeja de pizarra natural
plateau ardoise naturelle



	∅ cm	↑ cm	* mm
00989	25 / 20	24	6 - 9



Naturschieferplatte, 2-teilig

natural slate tray, 2 pcs.
bandeja de pizarra natural y campana
plateau ardoise naturelle et cloche en verre
mit Glashaube
with glass cover
con tapa de cristal
avec cloche en verre



	∅ cm	↑ cm	* mm
00984	10,5	8	6 - 9



Naturschieferplatten, 4er Set

natural slate tray, 4 pcs.
bandeja pizarra natural, set de 4
plat ardoise naturelles, set de 4



	cm	* mm	pcs.
00997	10 x 10	6 - 9	4



TRAY · BOARD



Buffetbrett „PROFI“ board tabla para el buffet planche découper buffet



aus geöltem Eichenholz, Safrinne, mit Antirutsch-Füßchen

made of oiled oak, with juice groove and non slip-feet

de madera de roble aceitada, con ranura para líquidos y pies antideslizantes

en bois chêne huilé, avec rigole et pieds antidérapants

	cm	↑ cm	fits to
00806	58 x 37,5	4,5	11026, 11027, 11028, 11008, 11010, 11016



GN 1/1 Servierbrett „GENUSSPALETTE“ GN 1/1 serving board GN 1/1 tabla de servir GN 1/1 planche de service



Genusspalette im Kleinformat, Birke

mini serving palett, birch

tabla de servir, formato pequeño, abedul

planche de service, petit format, bouleau

	cm	↑ cm	GN
00879	53 x 32,5	3	1/1



Servierbrett „GENUSSPALETTE“ serving board tabla de servir planche de service



Genusspalette im Kleinformat, Birke

mini serving palett, birch

tabla de servir, formato pequeño, abedul

planche de service, petit format, bouleau

	cm	↑ cm
00880	20 x 12	3
00881	30 x 20	3
00882	40 x 15	3

Wachspapier „SNACKHOLDER“ / greaseproof paper squares
papel alimenticio para cucurucho / papier alimentaire pour cornet

	cm	pcs.	
40670	42 x 25	500	Motiv: Zeitung
40671	42 x 25	500	blanco
40672	42 x 25	500	Motiv: rote Karos / red
40673	42 x 25	500	Motiv: blaue Karos / blue
40674	30 x 20	500	Motiv: Fast Food / black
40677	25 x 20	1000	Motiv: Zeitung
40678	31 x 31	1000	Motiv: Zeitung
40679	34 x 28	1000	Motiv: Zeitung



40674



40670

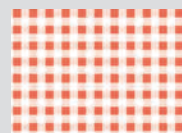

40672

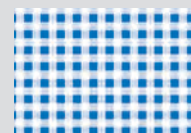

40673



Servierbrett, 2-teilig

serving board, 2 pcs.
 tabla de servir, set de 2
 planche de service, set de 2



2-teilig:

1 Holzbrett aus Akazienholz + 1 Naturschieferplatte

1 wood board made of acacia wood + 1 natural slate tray

1 tabla de madera de acacia + 1 pizarra natural

1 planche en bois d'acacia + 1 ardoise naturelle

	cm	↑ cm
00814	28 x 17,5	2



Servierbrett

serving board
 tabla de servir
 planche de service



Servierbrett aus geöltem Akazienholz

serving board made of oiled acacia wood

tabla de servir de madera de acacia aceitada

planche en bois avec plateau en bois d'acacia huilé

	cm	↑ cm
00897	30 x 15	2
00898	30 x 18	2
00899	35 x 25	2



Servierbrett, 2-teilig

serving board, 2 pcs.
 tabla de servir, set de 2
 planche de service, set de 2



2-teilig:

Ein rustikales Servierbrett aus Akazienholz, ausgestattet mit einer Naturschieferplatte

wood board oiled acacia with a slate tray

tabla de madera de acacia con una bandeja de pizarra natural

planche en bois d'acacia avec un plateau en ardoise naturelle

	cm	↑ cm	Griff / handle cm
00810	26 x 18	2	8
00811	33 x 20	2	8
00812	40 x 15	2	5
00813	43 x 12	2	12

Präsentationsmöglichkeit
 presentation example



mit Hängeloch Ø 2 cm / with a handle-hole Ø 2 cm



Servierbrett „SHARING“

serving board
tabla de servir
planche de service



Servierbrett aus geöltem Akazienholz
serving board made of oiled acacia wood
tabla de servir de madera de acacia aceitada
planche en bois d'acacia huilé

	cm	↑ cm	Griff / handle cm
00887	51,5 x 18	1,5	8,5



Servierbrett „AKAZIE-SCHIEFER“

serving board
tabla de servir
planche de service



raffiniertes, rustikales Servierbrett
aus Akazienholz, ausgestattet mit einem Naturschieferstreifen
zur Kennzeichnung

wood with slate, markable
madera con pizarra, se puede marcar
bois avec ardoise, on peut mettre une inscription

	cm	↑ cm	Griff / handle cm
00867	30,5 x 13	1,5	10
00868	36,5 x 15	1,5	12
00869	42,0 x 18	1,5	14



Servierbrett „OLIVE“

serving board
tabla de servir en madera de olivo
planche de service en bois d'olivier



Servierbrett im Naturschnitt, aus Olivenholz. Jedes Brett wird handgefertigt und geölt mit 19 mm Aufhäng Bohrung. Alle Produkte unterscheiden sich naturbedingt in Form, Maserung und Größe!

Olive Wood is known for its versatility and striking appearance with each piece having its own unique features.

El olivo es conocido por su versatilidad y aspecto espectacular y único en cada pieza. Por su fabricación a mano de forma artesanal, todas las piezas varían en tamaño, forma y acabado, lo que hace de cada una un ejemplar único.

Le bois d'olivier est reconnu pour sa versatilité et son esthétique spectaculaire. De par leur fabrication artisanale à la main, toutes les pièces varient quant à leur taille, forme et finition, de telle sorte que chacune est un exemplaire unique.

	cm	↑ cm	Griff / handle cm
00870	25 x 17,0	1,5	
00871	30 x 20,5	2,0	
00872	35 x 24,0	2,0	
00873	40 x 15,0	1,5	11
00874	44 x 20,0	2,0	12
00875	19 x 12,5	1,5	6
00876	25 x 16,0	1,5	8
00877	31 x 20,0	1,5	9

NEW



00818



06510



06512

Servier- und Tortenplatte

cake stand
porta pasteles
présentoir à gâteaux

Eichenholz geölt, mit Safrille

oak wood oiled, with juice groove
madera de roble aceitada, con ranura para líquidos
bois de chêne huilé, avec rainure à jus



	Ø cm	↑ cm
00818	32	2,0



06520

Präsentationsmöglichkeit
presentation example



passende Hauben / cover / campana / cloche

	Ø cm	↑ cm
06510	30	11,5
06512	30	11,5
06520	30	22



00905



00906

Servierbrett „OLIVE“

serving board
tabla de servir
planche de service

aus geöltem Olivenholz

oiled olive wood
de madera de olivo aceitada
en bois d'olivier huilé



	cm	↑ cm
00905	25,5 x 16,5	1,5
00906	35,0 x 20,5	1,5

Ø 9,5 cm



40601



Servierbrett „OAK“

serving board
tabla de servir
planche de service

aus geöltem Eichenholz, Safrille, ø 9,5 cm Aussparung

made of oiled oak, with juice groove, with hole ø 9.5 cm
de madera de roble aceitada, con ranura para líquidos, con agujero ø 9,5 cm
en bois chêne huilé, avec rainure à jus, avec trou ø 9,5 cm



	cm	↑ cm
00808	37 x 25	2



mit Safrille
with juice groove

NEW



01016



01017

Wachspapier
40677



01016



40671

40670

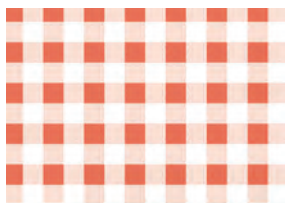

40672

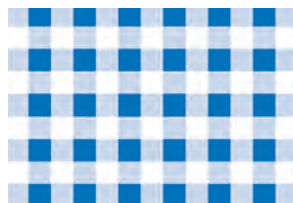

40673



40674



40678

Table Caddy „OLIVE“

table barrel
caddy de mesa
caddy de table



aus geöltem Olivenholz
oiled olive wood
de madera de olivo aceitada
en bois d'olivier huilé

	cm	↑ cm
01016	22 x 15	6
01017	25 x 18	6



Allzweckstreuer, 12 er Set / shaker, 12 pcs. / dosificador, set de 12 / salières/poivrières set de 12

	cm	↑ cm	ltr.
40504	4 x 4	10	0,07

passende Brottasche / suitable bread basket / panera a juego / corbeilla assortie

	cm	↑ cm	Farbe / Colour
30356	12 x 11,5	11,5	■

passende Mühlen / suitable mills/ molinos de ajuste / moulins assortis

	ø cm	↑ cm
40555	6	15,5
40556	6	15,5

Wachspapier „SNACKHOLDER“

greaseproof paper squares
papel alimenticio para cucurucho
papier alimentaire pour cornet



	cm	pcs.	
40670	42 x 25	500	Motiv: Zeitung
40671	42 x 25	500	blanco
40672	42 x 25	500	Motiv: rote Karos / red
40673	42 x 25	500	Motiv: blaue Karos / blue
40674	30 x 20	500	Motiv: Fast Food / black
40677	25 x 20	1000	Motiv: Zeitung
40678	31 x 31	1000	Motiv: Zeitung
40679	34 x 28	1000	Motiv: Zeitung



40674

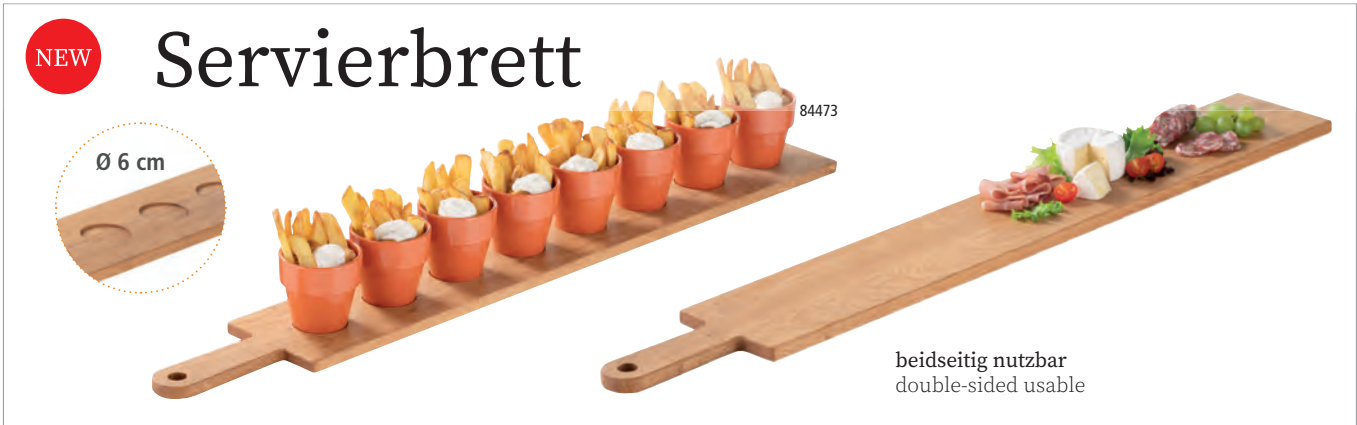

beidseitig nutzbar
double-sided usable

Servierbrett

servicing board
tabla de servir
planche de service



aus geöltem Eichenholz, mit 8 Vertiefungen Ø 6 cm
made of oiled oak wood, with 8 notches Ø 6 cm
de madera de roble aceitada con 8 ranuras Ø 6 cm
en bois de chêne huilé avec 8 encoches Ø 6 cm

	cm	↑ cm
00809	100 x 14	1,5

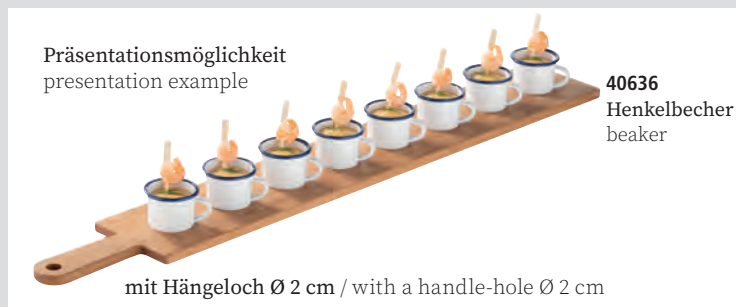

Präsentationsmöglichkeit
presentation example

40636
Henkelbecher
beaker

mit Hängeloch Ø 2 cm / with a handle-hole Ø 2 cm



NEW

mit Hängeloch Ø 1,5 cm
with a handle-hole Ø 1,5 cm

Präsentationsmöglichkeit
presentation example

Servierbrett

servicing board
tabla de servir
planche de service



aus geöltem Buchenholz mit Daumenmulde auf einer Seite
made of oiled beech wood with thumb recess on one side
de madera de haya aceitada con hueco para el pulgar en un lado
en bois de hêtre huilé avec encoche pour le pouce sur un côté

	cm	↑ cm
00817	60 x 19,5	2

TRAY · BOARD



Schale „OLIVE“

bowl
cuenco
bol



aus geöltem Olivenholz
oiled olive wood
de madera de olivo aceitada
en bois d'olivier huilé

	cm	↑ cm	ltr.
01013	7,5 x 7,5	2,5	0,05
01014	17,5 x 8,5	2,5	0,15
01015	26,5 x 11,5	5,0	0,60



Schale „OLIVE“

bowl
cuenco
bol



aus geöltem Olivenholz
oiled olive wood
de madera de olivo aceitada
en bois d'olivier huilé

	Ø cm	↑ cm	ltr.
01010	10,0	4,0	0,15
01011	12,5	4,5	0,25
01012	15,0	6,0	0,50



3 Größen ineinander
3 sizes in each other



Schale „OLIVE“

bowl
cuenco
bol



aus geöltem Olivenholz
oiled olive wood
de madera de olivo aceitada
en bois d'olivier huilé

	cm	↑ cm	ltr.
00843	12,0 x 7,5	2,5	0,05
00844	16,5 x 9,5	2,5	0,10



Schale „OLIVE“

bowl
cuenco
bol



aus geöltem Olivenholz
oiled olive wood
de madera de olivo aceitada
en bois d'olivier huilé

	cm	↑ cm	ltr.
00907	13 x 8	6,5	0,2
00908	16 x 9	7,0	0,3



Servierbeispiel - Lieferung ohne Gläser
delivery without glasses

Holzbox „TABLE“

woodbox
caja madera
base bois



Akazienholz, 3 Fächer (6,5 x 6,5 cm) / acacia wood, 3 compartments (6,5 x 6,5 cm)
madera de acacia, 3 compartimentos (6,5 x 6,5 cm) / bois d'acacia, 3 compartiments (6,5 x 6,5 cm)

	cm	↑ cm	inner size cm
11727	23,5 x 8,5	4,5	6,5 x 6,5 je Fach / each compartment



Servierbeispiel - Lieferung ohne Gläser
delivery without glasses

Servierbrett „NARROW I“

serving board
tabla de servir
planche de service



Akazienholz, mit 3 Vertiefungen Ø 4 cm / acacia wood, with 3 notches Ø 4 cm
madera de acacia, con 3 ranuras Ø 4 cm / bois d'acacia, avec 3 encoches Ø 4 cm

	cm	↑ cm
00864	22 x 8	1,5

passende Schälchen / fitting bowls / cuencos adecuados / bols apropiés

	Ø cm	↑ cm	ltr.	
82312	6	5,5	0,08	glass / 12 pcs
40685	6	3,0	0,05	stainless steel



Servierbeispiel - Lieferung ohne Schälchen
delivery without bowls

Servierbrett „NARROW II“

serving board
tabla de servir
planche de service



Akazienholz, mit 3 Vertiefungen Ø 6 cm
acacia wood, with 3 notches Ø 6 cm
madera de acacia, con 3 ranuras Ø 6 cm
bois d'acacia, avec 3 encoches Ø 6 cm

	cm	↑ cm
00878	31 x 11	2

passende Schälchen / fitting bowls / cuencos adecuados / bols apropiés

	Ø cm	↑ cm	ltr.	
40686	8	4,5	0,17	stainless steel

Buffetbrett „PROFI“



Buffetbrett „PROFI“

board
tabla para el buffet
planche découper buffet

aus geöltem Eichenholz, Safrinne, mit Antirutsch-Füßchen

made of oiled oak, with juice groove and non slip-feet

de madera de roble aceitada, con ranura para líquidos y pies antideslizantes

en bois chêne huilé, avec rigole et pieds antidérapants



	Ø cm	↑ cm	fits to
00815	23	4,5	6519
00805	33	4,5	6520, 6510, 6512
00816	39	4,5	6521

Frischhalte- Haube / cover / campana / cloche



	Ø cm	↑ cm	fits to
06512	30	11,5	00805

Frischhalte- Haube / cover / campana / cloche



	Ø cm	↑ cm	fits to
06519	21	17	00815
06520	30	22	00805
06521	36	27	00816



Buffetbrett „PROFI“

board
tabla para el buffet
planche découper buffet

aus geöltem Eichenholz, Safrinne, mit Antirutsch-Füßchen

made of oiled oak, with juice groove and non slip-feet

de madera de roble aceitada, con ranura para líquidos y pies antideslizantes

en bois chêne huilé, avec rigole et pieds antidérapants



	cm	↑ cm	fits to
00807	38 x 32,0	4,5	11021, 11022, 12008, 12010
00806	58 x 37,5	4,5	11026, 11027, 11028, 11008, 11010, 11016



00866

Brettstärke 4,5 cm
board thickness

Buffetbrett „XXL“

board
tabla para el buffet
planche à découper buffet



Buchenholz geölt, mit Antirutsch-Füßchen

beech wood oiled, with non-slip feet
madera de haya tratada con aceite, con pies antideslizantes
bois hêtre huilé, avec pieds antidérapants

	Ø cm	↑ cm
00866	50	4,5

Rolltophaube / rolltop cover / campana rolltop / cloche rolltop

	Ø cm	↑ cm
18380	50	26

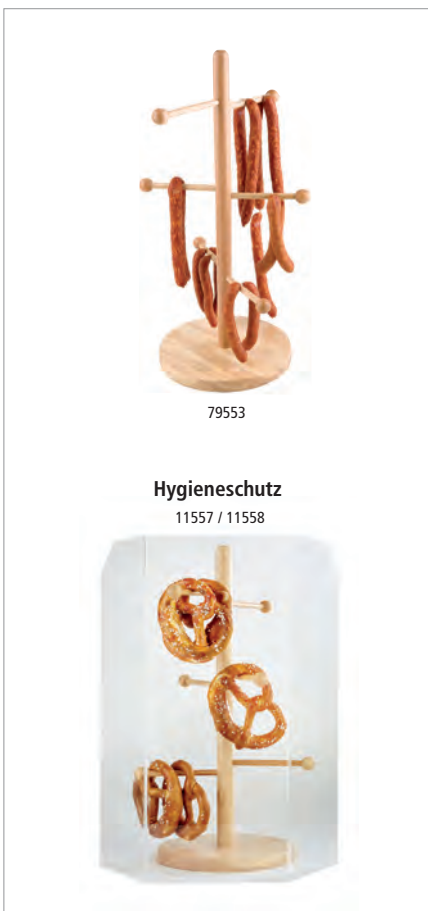

79553

Hygieneschutz
11557 / 11558

Brezel- oder Wurstständer

pretzel-/ sausage stand
soporte para embutidos
support à bretzel ou à saucissons



Verkaufsständer Buchen-Holz versiegelt, bestens geeignet für die Präsentation von Brezeln, Würstchen, etc., Fuß Ø 22 cm

beech wood, ideal to present pretzels, sausages, etc.
madera de haya, ideal para presentar fiambres, salchichones etc.
en hêtre, idéal pour bretzels ou saucissons, etc.

	Ø cm	↑ cm
79553	28	50

Hygieneschutz für Brezelständer / hygienic cover / cubierta higiénica antialiento / pare-haleine

	cm	↑ cm
11557	20 x 20 x 20	50
11558	15 x 20 x 15	50



Hobel für Käse und Schokolade

cheese / choco curler
rizador para queso y chocolate
frisette pour fromage et chocolat



3-teilig: Platte Buchen-Holz versiegelt Ø 22 cm mit senkrechtem Stift + Hobel 7 cm + Haube Ø 15 x 10 cm, für Käse und Schokolade

3 pcs.: wooden base Ø 22 cm with vertical bolt + plough 7 cm + cover Ø 15 x 10 cm, for cheese and chocolate

set de 3: base de madera Ø 22 cm, con eje vertical de 7 cm + campana Ø 15 x 10 cm, para „rizar“ queso y chocolate

set de 3: base bois Ø 22 cm, axe vertical ht. 7 cm, cloche Ø 15 x ht 10 cm, pour „friser“ le fromage ou le chocolat.

	Ø cm	↑ cm
50002	22	15

TRAY · BOARD



Brotschneidebrett „PROFI“

cutting board
tabla para cortar
planche à découper



	cm	↑ cm
00806	58 x 37,5	4



Brotschneidebrett „LETTER“

cutting board
tabla para cortar
planche à découper



	cm	↑ cm
00886	48 x 34	3,5



Brotschneidebrett „AKAZIA“

cutting board
tabla para cortar
planche à découper



	cm	↑ cm	GN
00883	47,5 x 32,0	2	
00884	53,0 x 32,5	2	1/1
00885	60,0 x 40,0	2	



praktisches Krümfach
practical crump shelf



Brotschneidebrett „RUBBERWOOD“

cutting board
tabla para cortar
planche à découper



	cm	↑ cm	GN
00955	47,5 x 32,0	2	
00956	53,0 x 32,5	2	1/1
00957	60,0 x 40,0	2	



praktisches Krümfach
practical crump shelf



Brotschneidebrett, 2-teilig

cutting board, 2 pcs.
tabla para cortar, set de 2
planche à découper, set de 2



2-teiliges Set, GN 1/1 Behälter, 20 mm tief, dient als Krümfach

2 pcs.: GN 1/1 pan 20 mm, bread crump shelf

set de 2: tabla de corte + bandeja inox GN 1/1 alt 20 mm (sirve para recoger las migas)

set de 2: planche à découper bois + plateau inox GN 1/1 Ht 20 mm (sert de ramassemiettes)

	cm	GN
00951	53 x 32,5	1/1

einzelnes Brett / separate board / tabla por separado / planche seule

	cm	GN
00952	53 x 32,5	1/1



00510

Serviertablett „HAPPY HOUR“

tray
bandeja
plateau



rutschfeste Oberfläche
non-slip surface
superficie anti deslizante
surface antidérapante

	Ø cm	↑ cm	Farbe / Colour
00510	32	1,5	■
00511	38	1,5	■
00515	43	1,5	■



00548

Tablett „GASTRO“

tray
bandeja
plateau



rutschfeste Oberfläche
non-slip surface
superficie anti deslizante
surface antidérapante

	Ø cm	↑ cm	Farbe / Colour
00547	27,5	2	■
00548	35,5	2	■
00549	40,5	2	■



Tablett „BISTRO“

tray
bandeja
plateau



rutschfest, mit 2 Griffmulden und Stapelrand
non-slip, two open handles, stackable edge
anti deslizante, 2 asas
antidérapant, 2 anses

	Ø cm	↑ cm	Farbe / Colour
84045	35,5	4,5	■



00500

00507

Bierglasträger „NON SLIP“

beer rack
bandeja para cerveza
porte verre à bière



rutschfeste Oberfläche
non-slip surface
superficie anti deslizante
surface antidérapante

	Ø cm	↑ cm	Farbe / Colour
00500	36	3,5	■
00501	36	3,5	■

	cm	↑ cm	Farbe / Colour
00506	28 x 20	1,5	■
00507	28 x 20	1,5	■

TRAY • BOARD



84620
oval 22 x 14 cm

84621
Ø 19 cm

Teller mit Glashalter „COCKTAIL“

plate with glass holder
plato sujeta copas
assiette porte-verre



eignet sich besonders für Stehempfänge, einhändig nutzbar
particularly suitable for standing receptions, single-handed use
para uso en recepciones de pie, facil de usar con sólo una mano
particulièrement pour des receptions debout, utilisable avec une seule main

	cm	↑ cm
84620	22 x 14	1,5



	Ø cm	↑ cm
84621	19	1,5

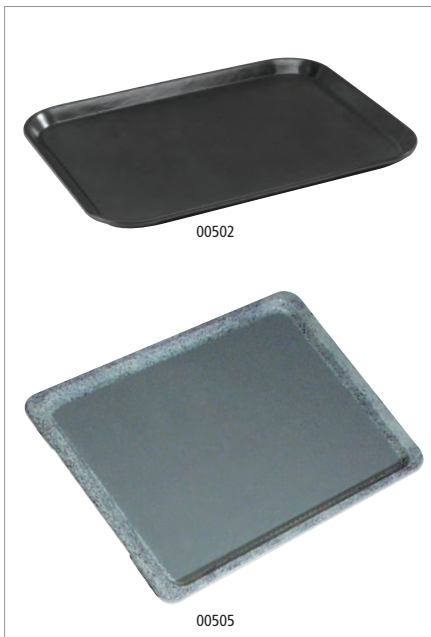

00502

00505

Serviertablett „NON SLIP“

tray non-slip
bandeja
plateau



rutschfeste Oberfläche
non-slip surface
superficie antideslizante
surface antidérapante

	cm	↑ cm	GN	Farbe / Colour
00502	53,0 x 32,5	1,5	1/1	■
00508	46,0 x 36,0	2,0		■
00505	53,0 x 32,5	1,5	1/1	■
00503	53,0 x 37,0	1,5		■



00526

Tablett

tray
bandeja
plateau



rutschfest, Holzdekor-Laminat
non-slip, coated wood
antideslizante, decoración madera láminae
antidérapant, décor bois laminé

	cm	↑ cm
00524	43,5 x 31,5	1,5
00525	52,0 x 39,0	1,5
00526	60,5 x 42,5	1,5



Fast Food-Tablett

snack tray
bandeja autoservicio y snacks
plateau self-service et snacks



	cm	↑ cm	GN	Farbe / Colour
00530	35 x 27,0	2		
00535	41 x 30,5	2		
00540	45 x 35,5	2		
00552	53 x 32,5	2	1/1	

	cm	↑ cm	GN	Farbe / Colour
00531	35 x 27,0	2		
00536	41 x 30,5	2		
00541	45 x 35,5	2		
00553	53 x 32,5	2	1/1	

	cm	↑ cm	GN	Farbe / Colour
00532	35 x 27,0	2		
00537	41 x 30,5	2		
00542	45 x 35,5	2		
00554	53 x 32,5	2	1/1	

	cm	↑ cm	GN	Farbe / Colour
00533	35 x 27,0	2		
00538	41 x 30,5	2		
00543	45 x 35,5	2		
00555	53 x 32,5	2	1/1	



Tablett

tray
bandeja
plateau



rutschfest, Mahagonifurnier
non-slip, woodform, mahogany
antideslizante, revestimento de caoba
antidérapant, placage en acajou

	Ø cm	↑ cm	
00528	31,0	3,5	hoher Rand
00529	35,5	3,5	hoher Rand



Tablett

tray
bandeja
plateau



rutschfest, Holzdekor-Laminat
non-slip, coated wood
antideslizante, limando decoracion madera
antidérapant, décor bois stratifié

	cm	↑ cm
00521	26 x 20	1
00522	29 x 21	1

CAKE STAND • COVER

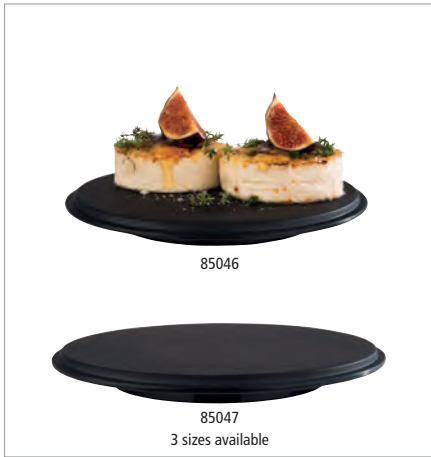

Torten- / Konditorplatte „SLATE“

cake stand
soporte para pastel
présentoir à gâteaux



Rand fixiert die Haube, mit Antirutsch-Füßchen, Schiefer Look

carved edge fixes the cover, with non-slip feet, slate look
ranura para fijar bien la campana, con pies antideslizantes, aspecto pizarra
bord rainuré pour maintenir ferme la cloche, avec pieds antidérapants, aspect ardoise



	Ø cm	↑ cm	fits to cover
85046	21,5	2,5	06519
85047	30,5	3,5	06520, 06512, 6510
85048	37,5	4,0	06521



Torten- / Konditorplatte „LOOPS“

cake stand
soporte para pastel
présentoir à gâteaux



	Ø cm	↑ cm	fits to cover
85033	21,5	2,5	06519
85034	30,5	3,5	06520, 06512, 06510
85035	37,5	4,0	06521

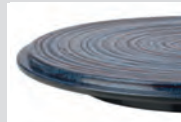

Rand fixiert die Haube, mit Antirutsch-Füßchen
carved edge fixes the cover, with non-slip feet



Torten- / Konditorplatte

cake stand
soporte para pastel
présentoir à gâteaux



Rand fixiert die Haube, mit Antirutsch-Füßchen

carved edge fixes the cover, with non-slip feet
ranura para fijar bien la campana, con pies antideslizantes
bord rainuré pour maintenir ferme la cloche, avec pieds antidérapants



	Ø cm	↑ cm	Farbe / Colour	fits to cover
00468	31	3,5	■	06520
00469	31	3,5	■	06520



Servier- und Tortenplatte „CASUAL“

cake plate
porta pasteles
présentoir à gâteaux



	Ø cm	↑ cm
83890	31	8
83891	31	16



Servier- und Tortenplatte „CASUAL“

cake plate
porta pasteles
présentoir à gâteaux



	cm	↑ cm
83892	31 x 31	8
83893	31 x 31	16



Servier- und Tortenplatte

cake stand
porta pasteles
présentoir à gâteaux



Eichenholz geölt / oak wood oiled / mader de roble aceitada / bois de chêne huilé

	Ø cm	↑ cm
00818	32	2,0



Konditorplatte

cake stand
soporte para pastel
présentoir à gâteaux



matt poliert
satin polished finish
acabado efecto satinado
poli mat effet satin

	Ø cm	↑ cm
00046	31	3



Servier- und Tortenplatte „CLASSIC“

cake stand
porta pasteles
présentoir à gâteaux



Rand fixiert die Haube
carved edge fixes the cover
ranura para fijar bien la campana
bord rainuré pour maintenir ferme la cloche

	Ø cm	↑ cm
85051	30,5	9
85052	30,5	17

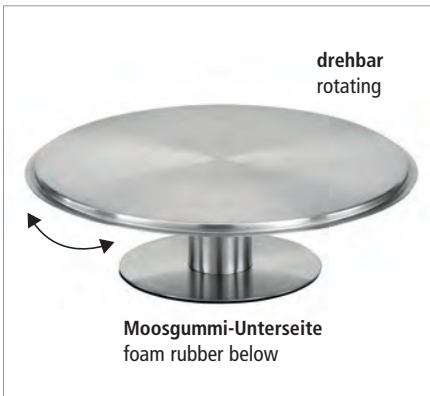

Servier- / Tortenplatte

cake stand
soporte para pastel
présentoir à gâteaux



matt poliert, drehbar, möbelschonende Moosgummi-Unterseite
satin polished finish, rotating, foam rubber below to save your furniture
acabado pulido satinado, giratorio, base revestida de goma para no rallar el mobiliario
poli satiné, plateau tournant, revêtement mousse sous le pied pour ne pas rayer les meubles

	Ø cm	↑ cm
00463	30,5	9

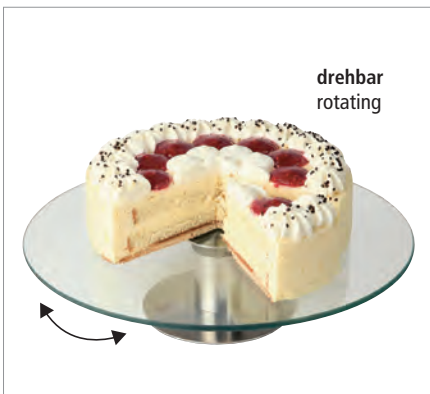

Servier- / Tortenplatte

cake stand
soporte para pastel
présentoir à gâteaux



Fuß matt poliert, drehbar, möbelschonende Moosgummi-Unterseite
foot satin polished finish, rotating, foam rubber below to save your furniture
vidrio, pie inox satinado giratorio, base de goma para proteger el mobiliario
plateau en verre, pied tournant inox poli satin, revêtement mousse sous le pied anti-rayures

	Ø cm	↑ cm
00444	30	7



Servier- und Tortenplatte „ACACIA MINI“

cake stand
porta pasteles
présentoir à gâteaux



Akazienholz geölt
acacia wood oiled
madera de acacia aceitada
bois d'acacia huilé

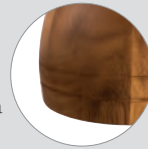

mit Rille
with groove

	Ø cm	↑ cm
33290	9,5	7
33291	13,0	9



Servier- und Tortenplatte „ACACIA“

cake stand
porta pasteles
présentoir à gâteaux



Akazienholz geölt, möbelschonende Unterseite
acacia wood oiled, with non-scratching undersurface
madera de acacia aceitada, con base anti rayaduras
bois d'acacia huilé, avec revêtement antirayures

	Ø cm	↑ cm
33292	24,0	8
33293	24,0	16
33294	33,0	8
33295	33,0	16
33296	38,5	8
33297	38,5	16



mit Rille
with groove

Frischhalte- Haube / cover / campana / cloche



	Ø cm	↑ cm	fits to
06519	21	17	33292, 33293
06520	30	22	33294, 33295
06521	36	27	33296, 33297

SUPER DOME



Frischhalte-Haube „SUPER DOME“

cover
campana
cloche



schwere, glasklare Qualität
stable, crystal clear quality
muy resistente y transparencia cristalina
haute résistance et transparence

	Ø cm	↑ cm
06525	30	40

passende Servier- Tortenplatten / suitable cake stands / porta pasteles compatibles /
présentoirs à gâteaux compatibles

	Ø cm	↑ cm	fits to	Farbe / Colour
85051	30,5	9,0	06525	
85052	30,5	17,0	06525	
00468	31,0	3,5	06525	
85112	32,0	3,5	06525	
33294	33,0	8,0	06525	
33295	33,0	16,0	06525	

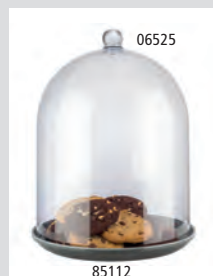

Servierbeispiel
presentation example

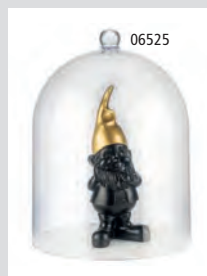

Präsentationsmöglichkeiten
presentation examples



CUTLERY BOX



Besteckbehälter „ACACIA“

cutlery box
recipiente para cubiertos
réipient pour couverts

HOLZ
WOOD

Akazienholz natur, 4 Fächer (26 x 11,5 cm)

acacia wood nature, 4 compartments (26 x 11,5 cm)
madera de acacia natural, 4 compartimentos (26 x 11,5 cm)
bois d'acacia naturel, 4 compartiments (26 x 11,5 cm)

	cm	↑ cm	Farbe / Colour
11952	51 x 28	13	



Besteckbehälter „VINTAGE“

cutlery box
recipiente para cubiertos
réipient pour couverts

HOLZ
WOOD

Akazienholz vintage weiß, 4 Fächer (26 x 11,5 cm)

acacia wood, vintage white, 4 compartments (26 x 11,5 cm)
madera de acacia, blanca vintage, 4 compartimentos (26 x 11,5 cm)
bois d'acacia, blanc vintage, 4 compartiments (26 x 11,5 cm)

	cm	↑ cm	Farbe / Colour
11951	51 x 28	13	



Besteckbehälter „ACACIA“ mit Deckel

cutlery box with cover
caja de cubiertos con tapa
range-couverts avec couvercle

HOLZ
WOOD

ACRYL
ACRYLIC



Akazienholz natur, 4 Fächer (26 x 11,5 cm)

acacia wood nature, 4 compartments (26 x 11,5 cm)
madera de acacia natural, 4 compartimentos (26 x 11,5 cm)
bois d'acacia naturel, 4 compartiments (26 x 11,5 cm)

	cm	↑ cm	Farbe / Colour
11949	51 x 28	14,5	



Besteckbehälter „VINTAGE“ mit Deckel

cutlery box with cover
caja de cubiertos con tapa
range-couverts avec couvercle

HOLZ
WOOD

ACRYL
ACRYLIC



Akazienholz vintage weiß, 4 Fächer (26 x 11,5 cm)

acacia wood, vintage white, 4 compartments (26 x 11,5 cm)
madera de acacia, blanca vintage, 4 compartimentos (26 x 11,5 cm)
bois d'acacia, blanc vintage, 4 compartiments (26 x 11,5 cm)

	cm	↑ cm	Farbe / Colour
11948	51 x 28	14,5	



GN 1/1 Besteckbehälter

GN 1/1 dispenser GN
GN 1/1 dispensador de cubiertos
GN 1/1 bac à couverts



in Handarbeit geflochten, 4 Mulden, Kunststoff-Geflecht, Drahtgestell, braun-schwarz

wickerwork, 4 compartments, with reinforced chromed wire structure, brown-black

cesta trensada a mano, 4 compartimentos, de plástico, con bastidor cromado reforzado, marrón oscuro

corbeille tressée à main, 4 compartiments, en plastique, cadre acier chromé renforcé, couleur marron foncé

	cm	↑ cm	Farbe / Colour
11966	53 x 32,5	9	



GN 1/1 Besteckbehälter „BUFFET“

GN 1/1 cutlery dispenser
GN 1/1 dispensador de cubiertos
GN 1/1 bac à couverts



4 Mulden, Kunststoff-Geflecht, Drahtgestell, beige

4 troughs, wickerwork, wire, beige

4 huecos, trabajo de cestería

4 compartiments, plastique tressé, cadre acier chromé renforcé, couleur osier naturel

	cm	↑ cm	Farbe / Colour
11965	53 x 32,5	10	



GN 1/1 Besteckbehälter

GN 1/1 cutlery tray / box stand
GN 1/1 dispensador de cubiertos
GN 1/1 bac à couverts



	cm	↑ cm	Farbe / Colour
11955	53 x 32,5	10	



GN 1/1 Besteckkasten

cutlery box GN 1/1
GN 1/1 dispensador de cubiertos
GN 1/1 bac à couverts



	cm	↑ cm	Farbe / Colour
11960	53 x 32,5	10	



GN 1/1 Besteckbehälter

GN 1/1 cutlery bin
GN 1/1 recipiente para cubiertos
GN 1/1 récipients pour couverts



	cm	↑ cm	Farbe / Colour
11954	53 x 32,5	10	
11955	53 x 32,5	10	

11954
GN 1/1

CUTLERY BOX



11998
Köcher weiß
PE white

11999
Köcher Edelstahl
stainless steel

Besteckköcher cutlery basket cesta para cubiertos corbeille à couverts



	Ø cm	↑ cm	
11998	9,7	13,7	Kunststoff weiß / white plastic plástico blanco / plastique blanc
11999	9,7	13,7	matt poliert / satin polished finish acero inoxidable / inox



11994

11997

Besteckbehälter cutlery basket dispensador de cubiertos présentoir à couverts



matt poliert
satin polished finish
inox mate (sin cubiertos)
inox mat

	cm	↑ cm	
11994	26,0 x 30 Ø 10	20	4 Löcher inkl. Köcher (Kunststoff) 4 holes incl. dispensers (plastic) 4 agujeros incl. dispensador plástico 4 places, avec 4 récipients (plastique)
11997	37,5 x 30 Ø 10	20	6 Löcher ohne Köcher 6 holes without dispensers 6 agujeros sin dispensador de plástico 6 places, sans récipients



Besteckbehälter cutlery basket recipiente para cubiertos récipients pour couverts



4 Löcher inkl. 4 Edelstahl Köcher
4 holes incl. 4 stainless baskets
4 agujeros, incl. 4 cestas de acero
4 places, avec 4 corbeilles inox

	cm	↑ cm	Farbe / Colour
93321	27 x 27	15	■



Besteckbehälter „ACACIA“ cutlery bin recipiente para cubiertos récipients pour couverts



Akazienholz natur
acacia wood nature
madera de acacia natural
bois d'acacia naturelle

	cm	↑ cm	Logo
11939	14 x 14	15	fork / knife / spoon

VINTAGE

**Table Caddy „VINTAGE“**

table caddy
caddy de mesa
caddy de table



unterteilt in 5 Fächer
divided into 5 compartments
dividido en 5 compartimentos
divisé en 5 compartiments

	cm	↑ cm
11608	22 x 15,5	11,5

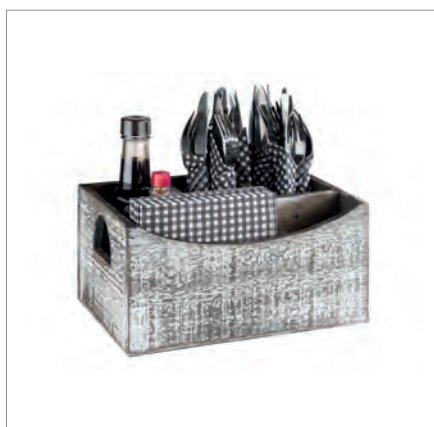
**Table Caddy „VINTAGE“**

table caddy
caddy de mesa
caddy de table



unterteilt in 7 Fächer
divided into 7 compartments
dividido en 7 compartimentos
divisé en 7 compartiments

	cm	↑ cm
11609	25,5 x 15,5	11,5

**Table Caddy „VINTAGE“**

table caddy
caddy de mesa
caddy de table



unterteilt in 4 Fächer, mit Tragegriff
divided into 4 compartments, with handle
dividido en 4 compartimentos, con asa
divisé en 4 compartiments, avec poignée

	cm	↑ cm
11610	22 x 15,5	22

CUTLERY BOX



Table Caddy „VINTAGE“

table caddy
caddy de mesa
caddy de table



herausnehmbare Aufteilung, 6 Fächer (7,5 x 7,5 cm)
separation removable, 6 compartments (7,5 x 7,5 cm)
separadores amovibles, 6 compartimentos (7,5 x 7,5 cm)
séparateurs amovibles, 6 compartiments (7,5 x 7,5 cm)

	cm	↑ cm	Farbe / Colour
11638	27 x 17	10	

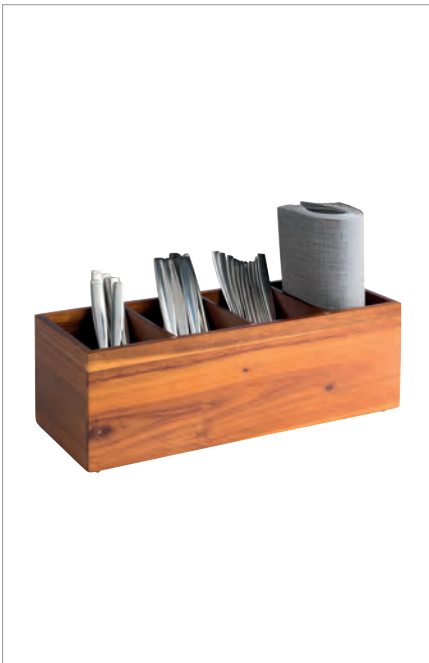

Holzbox „WOODY“

woodbox
caja madera
base bois



Akazienholz, 4-Fächer
acacia wood, 4 compartements
madera de acacia, 4 compartimentos
bois d'acacia, 4 compartiments

	cm	↑ cm	inner size cm
11649	36 x 14	12,5	12,5 x 8



Besteckbehälter „TIN“

cutlery bin
recipiente
récipient



Behälter aus Metall mit Tragegriff aus Holz
container made of metal with wooden handle
contenedor de metal con asa de madera
conteneur métallique avec poignée en bois

	cm	↑ cm
00014	24,5 x 12	18,5



inkl. Beschwerer



Serviettenhalter „HERO“

napkin holder
servilletero
porte-serviettes



für ca. 65 Cocktailservietten, inkl. Beschwerer

for approx. 65 cocktail napkins, incl. weight
para aprox. 65 servilletas cocktail, incl. barra de contrapeso
pour environ 65 serviettes cocktail, incl. barre de contrepoids

	cm	↑ cm	
11767	14,5 x 14,5	10	für 65 Servietten / for 65 napkins para 65 servilletas / pour 65 serviettes



inkl. Beschwerer



Serviettenhalter „HERO“

napkin holder
servilletero
porte-serviettes



für ca. 95 Servietten 1/4 Falz, inkl. Beschwerer

for approx. 95 cocktail napkins, incl. weight
para aprox. 95 servilletas cocktail, incl. barra de contrapeso
pour environ 95 serviettes cocktail, incl. barre de contrepoids

	cm	↑ cm	
11768	18,5 x 18,5	14	für 95 Servietten / for 95 napkins para 95 servilletas / pour 95 serviettes



inkl. Beschwerer



Serviettenhalter „URBAN“

napkin holder
servilletero
porte-serviettes



für ca. 50 Servietten, inkl. Beschwerer

for approx. 50 napkins, incl. weight
para aprox. 50 servilletas, incl. barra de contrapeso
pour environ 50 serviettes, incl. barre de contrepoids

	cm	↑ cm	
11770	19 x 19	7,5	für 50 Servietten / for 50 napkins para 50 servilletas / pour 50 serviettes



inkl. Beschwerer



Serviettenhalter „URBAN“

napkin holder
servilletero
porte-serviettes



für ca. 120 Servietten 1/4 Falz, inkl. Beschwerer

for approx. 120 cocktail napkins, incl. weight
para aprox. 120 servilletas de plegado ¼, incl. barra de contrapeso
pour environ 120 serviettes pliage ¼, incl. barrie de contrepoids

	cm	↑ cm	
11771	19 x 19	18	für 120 Servietten / for 120 napkins para 120 servilletas / pour 120 serviettes

NAPKINHOLDER



Serviettenhalter „WIRE“

napkin holder
servilletero
porte-serviettes



für Servietten 1/4 Falz, inkl. Beschwerer

for napkins 1/4 fold, incl. weight
para servilletas plegado 1/4, incl. barra de contrapeso
pour serviettes pliage 1/4, incl. barre de contrepoids

	cm	↑ cm	
11763	19 x 19	6,5	für 50 Servietten / for 50 napkins para 50 servilletas / pour 50 serviettes



Serviettenhalter „WIRE“

napkin holder
servilletero
porte-serviettes



für Servietten 1/4 Falz, inkl. Beschwerer

for napkins 1/4 fold, incl. weight
para servilletas plegado 1/4, incl. barra de contrapeso
pour serviettes pliage 1/4, incl. barre de contrepoids

	cm	↑ cm	
11765	19 x 19	19,0	für 150 Servietten / for 150 napkins para 150 servilletas / pour 150 serviettes

11765



Serviettenhalter „BAR“

napkin holder
servilletero
porte-serviettes



für ca. 50 Cocktailservietten, inkl. Beschwerer

for approx. 50 cocktail napkins, incl. weight
para aprox. 50 servilletas cocktail, incl. barra de contrapeso
pour environ 50 serviettes cocktail, incl. barre de contrepoids

	cm	↑ cm	
11762	14 x 14	6,5	für 50 Servietten / for 50 napkins para 50 servilletas / pour 50 serviettes



Serviettenhalter

napkin holder
servilletero
porte-serviettes



matt poliert

satin polished finish
acabado satinado
mat satiné

	cm	↑ cm	
11730	17 x 17	5	



Serviettenhalter „ELEMENT“

napkin holder
servilletero
porte-serviettes



aus Beton, für ca. 50 Servietten, mit möbelschonender Unterseite
concrete, for approx. 50 napkins, with furniture-friendly underside
hormigón, para aprox. 50 servilletas, con base anti rayaduras
béton, pour environ 50 serviettes, avec revêtement antirayures

	cm	↑ cm	
11781	16 x 7,5	10	für 50 Servietten / for 50 napkins para 50 servilletas / pour 50 serviettes



Serviettenhalter

napkin holder
servilletero
porte-serviettes



hochglanzpoliert, für Servietten mit 1/8 Falz, Füße mit rutsch- und kratzfester Gummierung
mirror polished finish, for napkins with 1/8 fold, rubber feet
pulido brillante, para servilletas plegado 1/8, con revestimiento de goma
poli miroir, pour serviettes pliage 1/8, avec revêtement en caoutchouc

	cm	↑ cm	
11720	10 x 11,5	18,5	



Serviettenhalter

napkin holder
servilletero
porte-serviettes



möbelschonende Unterseite, für ca. 30 Servietten, matt poliert
furniture-friendly underside, for approx. 30 napkins, satin polished finish
con base anti rayaduras, para aprox. 30 servilletas, pulido mate
avec revêtement antirayures, pour environ 30 serviettes, poli mat

	cm	↑ cm	
11780	15 x 4,5	12,5	für 30 Servietten / for 30 napkins para 30 servilletas / pour 30 serviettes



Serviettenhalter

napkin holder
servilletero
porte-serviettes



möbelschonende Unterseite, für ca. 20 Servietten, matt poliert
furniture-friendly underside, for approx. 20 napkins, satin polished finish
con base anti rayaduras, para aprox. 20 servilletas, pulido mate
avec revêtement antirayures, pour environ 20 serviettes, poli mat

	cm	↑ cm	
11778	17 x 3	7	für 20 Servietten / for 20 napkins para 20 servilletas / pour 20 serviettes





Buffet & Tableware Melamine



MOON



Servierset „MOON“, 6-teilig
 serving set, 6 pcs.
 set para servir, set de 6
 set de service, set de 6



6-teiliges Set: 3 Schalen + 3 Löffel
 6 pcs.: 3 bowls + 3 spoons
 set de 6: 3 cuencos + 3 cucharas
 set de 6: 3 bols + 3 cuillères

	Ø cm	↑ cm	ltr.	Farbe / Colour
85080	8	7,5	0,05	
85081	8	7,5	0,05	





Servierset „MOON“, 2-teilig

serving set, 2 pcs.
set para servir, set de 2
set de service, set de 2



2-teiliges Set: 1 Schale + 1 klappbarer Deckel

2 pcs.: 1 bowl + 1 hinged cover

set de 2: 1 cuenco + 1 tapa con bisagra

set de 2: 1 bol + 1 couvercle avec charnières

	Ø cm	↑ cm	ltr.	Farbe / Colour
85082	19	17,5	0,8	
85083	19	17,5	0,8	

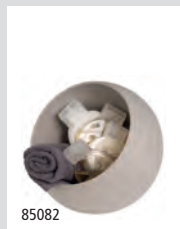

klappbarer Deckel
hinged cover

Präsentationsmöglichkeit
presentation example

Klappdeckel „Moon“ mit Silikondichtung / hinged cover with silicone seal / tapa con bisagra con junta de silicona / couvercle avec charnières avec joint en silicone

	Ø cm	↑ cm	fits to
85084	16	1,5	85082, 85083



84938
Tablett / tray

EMMA

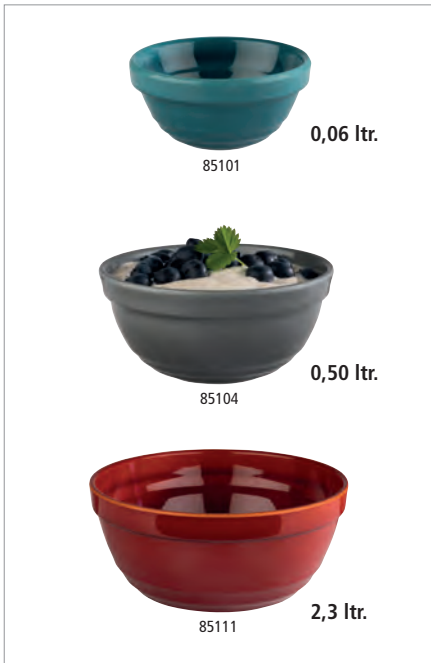

Schale „EMMA“ bowl cuenco bol



	Ø cm	↑ cm	ltr.	Farbe / Colour
85100	7,5	3,5	0,06	■
85101	7,5	3,5	0,06	■
85103	7,5	3,5	0,06	■
85104	14	6,5	0,5	■
85105	14	6,5	0,5	■
85107	14	6,5	0,5	■
85108	23	10,5	2,3	■
85109	23	10,5	2,3	■
85111	23	10,5	2,3	■

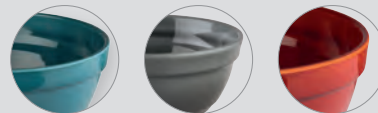

Teller „EMMA“ plate plato assiette



	Ø cm	↑ cm	Farbe / Colour
85112	32	3,5	■
85113	32	3,5	■
85115	32	3,5	■
85116	40,5	5,5	■
85117	40,5	5,5	■
85119	40,5	5,5	■





GN Tablett „EMMA“

GN tray
GN bandeja
GN plateau



	cm	↑ cm	GN	Farbe / Colour
85120	26,5 x 16,2	3	1/4	■
85121	26,5 x 16,2	3	1/4	■
85123	26,5 x 16,2	3	1/4	■
85124	32,5 x 26,5	3	1/2	■
85125	32,5 x 26,5	3	1/2	■
85127	32,5 x 26,5	3	1/2	■



GN Schale „EMMA“

GN bowl
GN cuenco
GN bol



	cm	↑ cm	ltr.	GN	Farbe / Colour
85128	26,5 x 16,2	7,5	1,5	1/4	■
85129	26,5 x 16,2	7,5	1,5	1/4	■
85131	26,5 x 16,2	7,5	1,5	1/4	■
85132	32,5 x 26,5	7,5	3,5	1/2	■
85133	32,5 x 26,5	7,5	3,5	1/2	■
85135	32,5 x 26,5	7,5	3,5	1/2	■

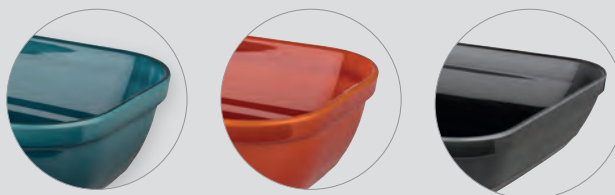

❄️ Cooling bowl ❄️



NERO



85067 GN 1/1

85068 GN 1/2



85067 GN 1/1

85068 GN 1/2

GN Tablett „NERO“

GN tray
GN bandeja
GN plateau



	cm	↑ cm	GN
85067	53,0 x 32,5	2,5	1/1
85068	32,5 x 26,5	2,5	1/2

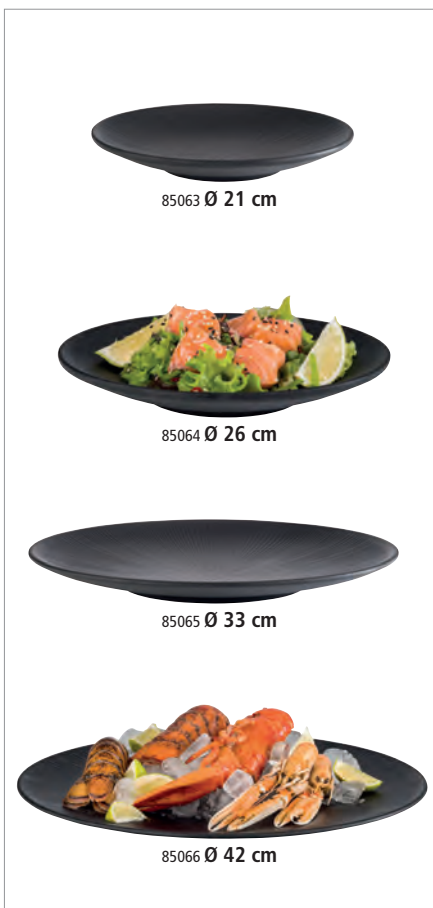
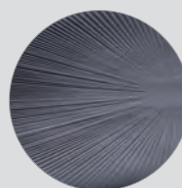
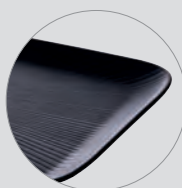

85063 Ø 21 cm

85064 Ø 26 cm

85065 Ø 33 cm

85066 Ø 42 cm

Teller „NERO“

plate
plato
assiette



	Ø cm	↑ cm
85063	21	3
85064	26	3
85065	33	3,5
85066	42	3,5

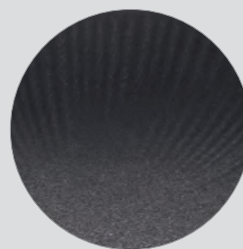
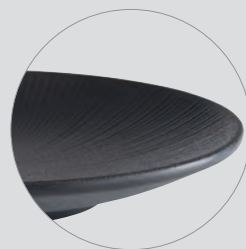



Schale „NERO“

bowl
cuenco
bol



	Ø cm	↑ cm	ltr.
85069	16	6,5	0,5
85070	19	8,0	0,9
85061	24	9,0	1,7

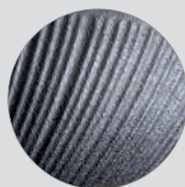
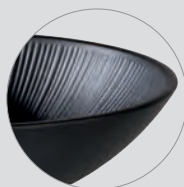

Schale „NERO“

bowl
cuenco
bol



	Ø cm	↑ cm	ltr.
85060	22,5	4,5	0,8
85062	30,0	7,0	2,2

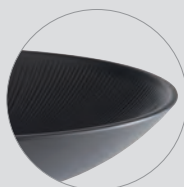

Schale „NERO“

bowl, square
cuenco, cuadrado
bol creux carré



	cm	↑ cm	ltr.
85071	19,5 x 19,5	8	1,5
85072	25,0 x 25,0	11	3,5

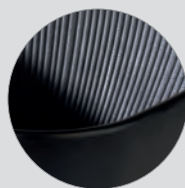
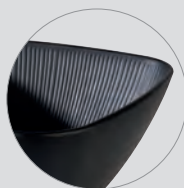



⊕ Kompatibilität / compatibility / combinación / compatibilité

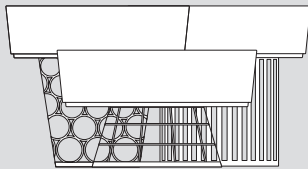

BASKETS
RISERS

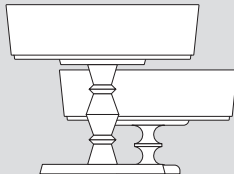

WOOD
RISERS

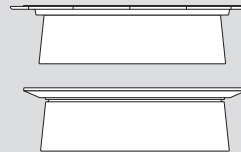

BAKERY / WOOD
PLATES

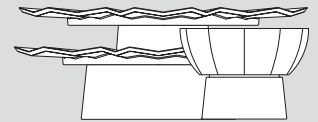

LOTUS
BOWLS / PLATES



15225

15227

GN Tablett TILES „APS+“

GN tray
GN bandeja
GN plateau



	cm	↑ cm	GN	Farbe / Colour
15225	26,5 x 16,2	1,5	1/4	■
15226	32,5 x 17,5	1,5	1/3	■
15228	32,5 x 26,5	1,5	1/2	■
15227	53,0 x 16,2	1,5	2/4	■

Passender Deckel 15348
matching cover 15348



15116

GN 1/4 Schale „APS+“

GN 1/4 bowl
GN 1/4 cuenco
GN 1/4 bol



	cm	↑ cm	GN	litr.	Farbe / Colour
15116	26,5 x 16,2	7	1/4	1,5	■
15117	26,5 x 16,2	9	1/4	2,5	■

Passende Deckel / cover / tapa / couvercle

	cm	↑ cm	GN
15348	26,5 x 16,2	1,5	1/4



Schale, quadratisch „APS+“

bowl, square
cuenco cuadrado
bol carré



	cm	↑ cm	ltr.	Farbe / Colour
15110	6,5 x 6,5	6	0,15	
15111	9,0 x 9,0	4	0,15	
15112	13,0 x 13,0	7	0,60	



Schale, quadratisch „APS+“

bowl, square
cuenco cuadrado
bol carré



	cm	↑ cm	ltr.	Farbe / Colour
15113	20,0 x 20,0	7	1,5	
15114	24,0 x 24,0	9	3,5	
15115	26,5 x 26,5	9	4,0	

Passende Deckel / cover / tapa / couvercle

	cm	↑ cm	
15345	20 x 20	1,5	
15346	24 x 24	1,5	
15347	26,5 x 26,5	1,5	



Schale, rund „APS+“

bowl, round
cuenco, redondo
bol rond



	Ø cm	↑ cm	ltr.	Farbe / Colour
15100	6,5	6	0,15	
15101	9,0	4	0,15	
15102	13,0	7	0,60	



Schale, rund „APS+“

bowl, round
cuenco, redondo
bol rond



	Ø cm	↑ cm	ltr.	Farbe / Colour
15600	6,5	6	0,15	
15601	6,5	6	0,15	
15603	9,0	4	0,15	
15604	9,0	4	0,15	
15605	9,0	4	0,15	



Schale, rund „ASIA PLUS“

bowl, round
cuenco, redondo
bol rond



	Ø cm	↑ cm	ltr.	Farbe / Colour
15105	20,0	7	1,5	—
15106	24,0	9	2,7	—
15108	32,5	9	4,0	—

Passende Deckel / cover / tapa / couvercle



	Ø cm	↑ cm
15340	16	1,5
15341	20	1,5
15342	24	1,5
15343	26,5	1,5
15344	32,5	1,5



GN 1/4 Schale „ASIA PLUS“

GN 1/4 bowl
GN 1/4 cuenco
GN 1/4 bol



	cm	↑ cm	GN	ltr.	Farbe / Colour
15219	26,5 x 16,2	7	1/4	1,5	—
15220	26,5 x 16,2	9	1/4	2,5	—
15234	26,5 x 16,2	7	1/4	1,5	—
15235	26,5 x 16,2	9	1/4	2,5	—

Passende Deckel / cover / tapa / couvercle



	cm	↑ cm	GN
15348	26,5 x 16,2	1,5	1/4



Schale „ASIA PLUS“

bowl
cuenco
bol



	cm	↑ cm	ltr.	Farbe / Colour
15215	13,0 x 13,0	7	0,6	
15216	20,0 x 20,0	7	1,5	
15217	24,0 x 24,0	9	3,5	
15218	26,5 x 26,5	9	4,0	
15232	20,0 x 20,0	7	1,5	
15233	26,5 x 26,5	9	4,0	

Passende Deckel / cover / tapa / couvercle



	cm	↑ cm		
15345	20 x 20	1,5		
15346	24 x 24	1,5		
15347	26,5 x 26,5	1,5		



Schale „ASIA PLUS“

bowl
cuenco
bol



	Ø cm	↑ cm	ltr.	Farbe / Colour
15230	20,0	7	1,5	
15231	32,5	9	4,0	

Passende Deckel / cover / tapa / couvercle



	Ø cm	↑ cm		
15341	20	1,5		
15344	32,5	1,5		



Schale „ASIA PLUS“

bowl
cuenco
bol



	Ø cm	↑ cm	ltr.	Farbe / Colour
15200	6,5	6	0,15	
15201	9,0	4	0,15	



Schale „ASIA PLUS“

bowl
cuenco
bol



	cm	↑ cm	ltr.	Farbe / Colour
15204	6,5 x 6,5	6	0,15	
15205	9,0 x 9,0	4	0,15	



GN Tablett „ASIA PLUS“

GN tray
GN bandeja
GN plateau



	cm	↑ cm	GN	Farbe / Colour
15449	53,0 x 32,5	3	1/1	
15450	32,5 x 26,5	3	1/2	
15451	32,5 x 17,6	3	1/3	
15452	26,5 x 16,2	3	1/4	
15453	35,4 x 32,5	3	2/3	
15454	53,0 x 16,2	3	2/4	
15455	53,0 x 32,5	3	1/1	
15456	32,5 x 26,5	3	1/2	
15457	32,5 x 17,6	3	1/3	
15458	26,5 x 16,2	3	1/4	
15460	53,0 x 16,2	3	2/4	

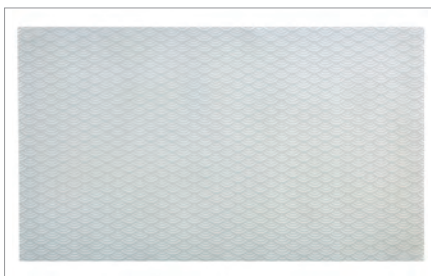

Antirutschmatte „ASIA PLUS“

non slip mat
esterilla antideslizante
tapis antidérapant



	cm	fits to
15497	51 x 31,0	15449, 15455
15499	31 x 25,5	15450, 15456



Antirutschmatte „ASIA PLUS“

non slip mat
esterilla antideslizante
tapis antidérapant



	cm	fits to
15498	51 x 31,0	15449, 15455
15500	31 x 25,5	15450, 15456

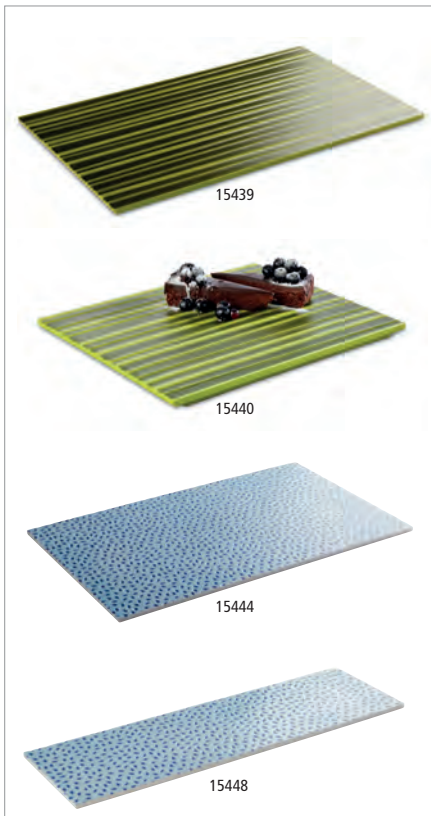

GN Tablett „ASIA PLUS“

GN tray
GN bandeja
GN plateau



	cm	↑ cm	GN	Farbe / Colour
15439	53,0 x 32,5	1,5	1/1	
15440	32,5 x 26,5	1,5	1/2	
15443	53,0 x 16,2	1,5	2/4	
15444	53,0 x 32,5	1,5	1/1	
15445	32,5 x 26,5	1,5	1/2	
15448	53,0 x 16,2	1,5	2/4	





ASIA+



Schale „ASIA PLUS“

bowl
cuenco
bol



	Ø cm	↑ cm	ltr.	Farbe / Colour
15400	7,5	3,5	0,06	White
15401	9,5	4,5	0,13	White
15402	13,0	5,5	0,35	White
15403	16,0	7,0	0,60	White
15404	20,0	8,0	1,10	White
15405	24,0	9,5	2,20	White
15406	26,5	11,0	3,00	White
15407	32,5	12,5	5,40	White
15408	7,5	3,5	0,06	White/Blue
15409	9,5	4,5	0,13	White/Blue
15410	13,0	5,5	0,35	White/Blue
15411	16,0	7,0	0,60	White/Blue
15412	20,0	8,0	1,10	White/Blue
15413	24,0	9,5	2,20	White/Blue
15414	26,5	11,0	3,00	White/Blue
15415	32,5	12,5	5,40	White/Blue
15416	7,5	3,5	0,06	Black/Red
15417	9,5	4,5	0,13	Black/Red
15418	13,0	5,5	0,35	Black/Red
15419	16,0	7,0	0,60	Black/Red
15420	20,0	8,0	1,10	Black/Red
15421	24,0	9,5	2,20	Black/Red
15422	26,5	11,0	3,00	Black/Red
15423	32,5	12,5	5,40	Black/Red



Deckel mit Löffelaussparung

cover with notched for spoons
tapa con espacio para la cuchara
couverture avec encoche pour la louche



	Ø cm	↑ cm	fits to
15340	16,0	1,5	15403, 15411, 15419
15341	20,0	1,5	15404, 15412, 15420
15342	24,0	1,5	15405, 15413, 15421
15343	26,5	1,5	15406, 15414, 15422
15344	32,5	1,5	15407, 15415, 15423



Teller „ASIA PLUS“
plate
plato
assiette



	Ø cm	↑ cm	Farbe / Colour
15424	11,0	2	White
15425	16,0	2	White
15427	24,0	2	White

	Ø cm	↑ cm	Farbe / Colour
15429	11,0	2	White/Blue
15430	16,0	2	White/Blue
15432	24,0	2	White/Blue

	Ø cm	↑ cm	Farbe / Colour
15434	11,0	2	Black/Red
15435	16,0	2	Black/Red
15437	24,0	2	Black/Red







Bento Box „ASIA PLUS“



	Ø cm	↑ cm	ltr.	Farbe / Colour
15461	7,5	3,0	0,04	White
15462	7,5	6,5	0,13	White



	Ø cm	↑ cm	ltr.	Farbe / Colour
15467	7,5	3,0	0,04	Black/Red
15468	7,5	6,5	0,13	Black/Red

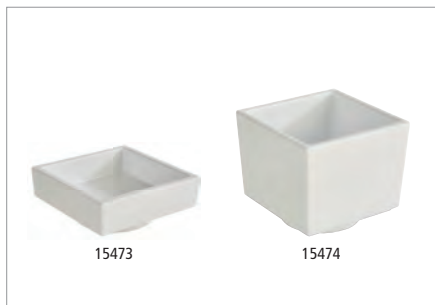

	cm	↑ cm	ltr.	Farbe / Colour
15473	7,5 x 7,5	3,0	0,05	White
15474	7,5 x 7,5	6,5	0,16	White
15479	15,5 x 15,5	3,0	0,19	White



	cm	↑ cm	ltr.	Farbe / Colour
15485	7,5 x 7,5	3,0	0,05	Black/Red
15486	7,5 x 7,5	6,5	0,16	Black/Red
15491	15,5 x 15,5	3,0	0,19	Black/Red



	cm	↑ cm	ltr.	Farbe / Colour
15475	15,5 x 7,5	3,0	0,10	White
15477	15,5 x 9,5	3,0	0,15	White
15483	25,0 x 15,5	3,0	0,30	White



	cm	↑ cm	ltr.	Farbe / Colour
15487	15,5 x 7,5	3,0	0,10	Black/Red
15495	25,0 x 15,5	3,0	0,30	Black/Red

ASIA+





Buffetständer / -korb „ASIA PLUS“

buffet stand / basket
soporte para buffet / cestas
présentoir buffet / corbeilles



	∅ cm	↑ cm	Farbe / Colour
15507	15	10,5	■
15508	21	10,5	■
15509	21	20	■



GN Buffetständer „ASIA PLUS“

GN buffet stand
GN soporte para buffet
GN présentoir buffet



	cm	GN	Farbe / Colour
15501	53,0 x 32,5 / 53,0 x 16,2	1/1 / 2/4	■
15502	32,5 x 26,5 / 26,5 x 16,2	1/2 / 1/4	■
15503	32,5 x 17,5 / 35,4 x 32,5	1/3 / 2/3	■
15504	53,0 x 32,5 / 53,0 x 16,2	1/1 / 2/4	■
15505	32,5 x 26,5 / 26,5 x 16,2	1/2 / 1/4	■
15506	32,5 x 17,5 / 35,4 x 32,5	1/3 / 2/3	■

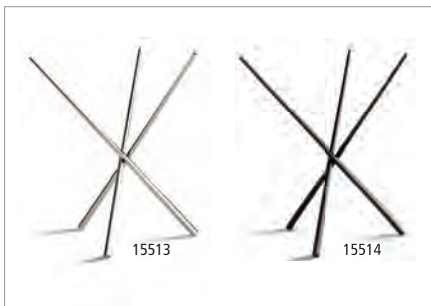

Buffetständer „ASIA PLUS“

buffet stand
soporte para buffet
présentoir buffet



	∅ cm	↑ cm	Farbe / Colour
15513	20,5 / 16,5	20	stainless steel
15514	20,5 / 16,5	20	■



Korb / Ständer „ASIA PLUS“

basket / riser
cesta / soporte
corbeille / support



	∅ cm	↑ cm	Farbe / Colour
15320	10,5 / 8	8	■
15324	10,5 / 8	8	■
15322	10,5 / 8	8	■

HANOI



Die ansteigenden Schalenformen erzeugen eine asiatische Marktopitik und verleihen Ihrem Buffet durch die gewobene Oberflächenstruktur eine natürliche Authentizität.

The rising bowl forms create an Asian market look and give your buffet a natural authenticity through the woven surface structure.

La forma creciente de los cuencos crea un look de un mercado asiático y le dá a su buffet una autenticidad natural gracias a la estructura de la superficie tejida.

La forme croissante de bols crée un aspect visuel d'une marché asiatique et donne à votre buffet une authenticité naturelle à travers la structure de surface tissée.



Schale / Teller „HANOI“

bowl / plate
cuenco / plato
bol / assiette



	∅ cm	↑ cm
84725	25,5	3,0 / 6,5
84726	30,0	3,5 / 7,5
84727	35,5	4,0 / 9,0



BLUE OCEAN



Da geht die Sonne auf!
Maritime Aquatöne,
Farbverläufe und klassisches
Blau-Weiß erinnert an eine
griechische Taverne in der
Ägäis.

The sun is rising!
Maritime aqua tones,
gradients and classic blue
and white reminiscent of
a Greek tavern in the
Aegean Sea.

¡Está saliendo el sol! Los tonos marinos, los degradados de color, el clásico azul y blanco recuerdan a una taberna griega en el mar Egeo.

Le soleil se lève! Les tons maritimes, les dégradés de couleurs, le bleu et le blanc classiques, tout rappellent une taverne grecque de la mer Égée.

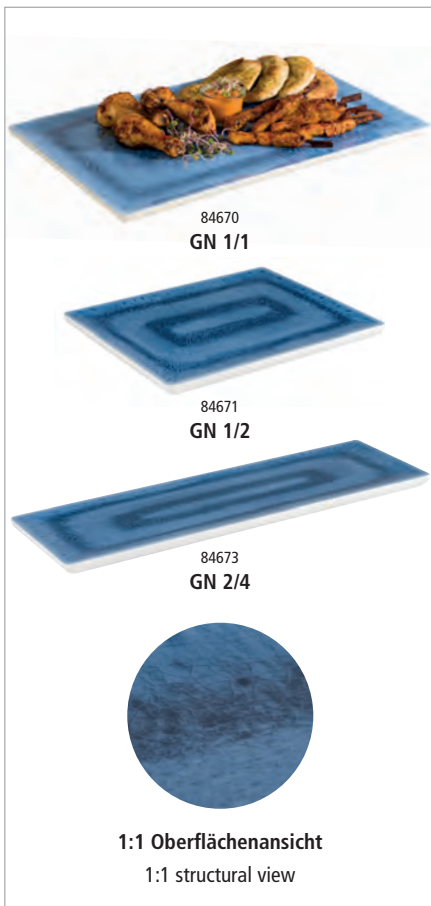

GN Tablett „BLUE OCEAN“

GN tray
GN bandeja
GN plateau



	cm	↑ cm	GN
84670	53,0 x 32,5	2	1/1
84671	32,5 x 26,5	2	1/2
84672	32,5 x 17,6	2	1/3
84673	53,0 x 16,2	2	2/4

GN 1/1	GN 1/2	GN 2/4	GN 1/3
	GN 1/2		GN 1/3
			GN 1/3

mit Antirutschfüßchen
with non-slip feet





Tablett „BLUE OCEAN“

tray
bandeja
plateau



	cm	↑ cm
84676	48 x 35,5	3

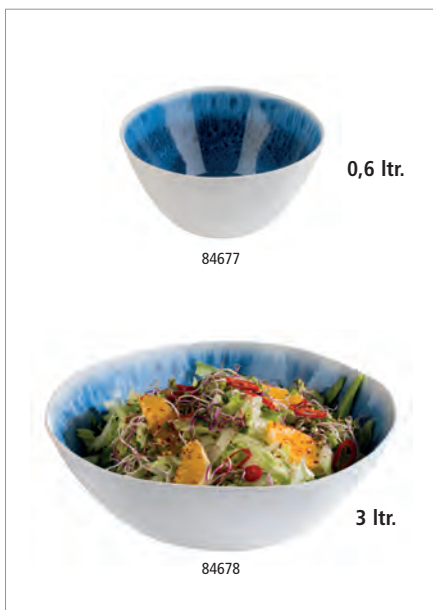

0,6 ltr.

84677

Schale „BLUE OCEAN“

bowl
cuenco
bol



	Ø cm	↑ cm	ltr.
84677	15	7,5	0,6

	Ø cm	↑ cm	ltr.
84678	30,5	9	3



84674

84675

Teller „BLUE OCEAN“

plate
plato
assiette



	Ø cm	↑ cm
84674	21,5	2
84675	26,5	2



84678



84677



84678



ARABESQUE

Beim Anblick der mediterranen Melamin Serie ARABESQUE bekommt man direkt Lust auf eine Tapas-Party. Mit seinem spanischen Charme und den wundervoll ausgearbeiteten Details holen Sie sich ein Stück Spanien auf Ihr Buffet.

When looking at the Mediterranean melamine series ARABESQUE, the longing for a tapas party resurfaces. With its Spanish charm and the beautifully crafted details, you get a slice of Spain on your buffet.

Al ver la serie mediterránea de melamina ARABESQUE, se obtiene un dicho antojo por una fiesta de tapas. Con su encanto español y los detalles bellamente elaborados, obtenga una rebanada de España en su buffet.

En regardant la série de mélamine méditerranéenne ARABESQUE, vous obtenez envie de préparer une fête de tapas. Avec son charme espagnol et les détails joliment ouvrés, vous aurez une tranche d'Espagne sur votre buffet.



GN Tablett „ARABESQUE“

GN tray
GN bandeja
GN plateau



	cm	↑ cm	GN
84680	53,0 x 32,5	2	1/1
84681	32,5 x 26,5	2	1/2
84682	32,5 x 17,6	2	1/3
84683	53,0 x 16,2	2	2/4





84687



84688



84689



84690

Schale „ARABESQUE“

bowl
cuenco
bol

	∅ cm	↑ cm	litr.
84687	10,0	6,0	0,2
84688	15,5	8,0	0,8

	∅ cm	↑ cm	litr.
84689	20,5	5,5	1,1
84690	31,0	9,0	3,0



1:1 Oberflächenansicht

1:1 structural view

Teller „ARABESQUE“

plate
plato
assiette

	cm	↑ cm
84686	38 x 15,5	2



84684



84685

Teller „ARABESQUE“

plate
plato
assiette

	∅ cm	↑ cm
84684	21,5	2
84685	26,5	2



Teller „BAMBOO“
plate
plato
assiette



	cm	↑ cm
84809	24 x 17	3,5



Schale „BAMBOO“
bowl
cuenco
bol



	cm	↑ cm	ltr.
84815	10,5 x 10,0	3,0	0,03
84816	17,5 x 15,5	5,5	0,2



Schale „BAMBOO“
bowl
cuenco
bol



	Ø cm	↑ cm	ltr.
84819	30,5	8,5	2



Schale „BAMBOO“
bowl
cuenco
bol



	cm	↑ cm	ltr.
84817	18,0 x 17,5	5,5	0,3
84818	23,0 x 22,0	7,0	0,7



Tablett „BAMBOO“

tray
bandeja
plateau



	cm	↑ cm
84803	10,0 x 10,0	2,0
84804	14,5 x 14,5	2,5
84805	31,0 x 10,5	2,0
84806	21,0 x 13,0	3,0
84807	24,5 x 15,5	3,0
84808	34,5 x 21,5	3,0



GN Tablett „BAMBOO“

tray
bandeja
plateau



	cm	↑ cm	GN
84800	53,0 x 32,5	2	1/1
84801	32,5 x 26,5	2	1/2
84802	32,5 x 17,6	2	1/3



Tablett „BAMBOO“

tray
bandeja
plateau



	cm	↑ cm
84811	24,5 x 15	3,5
84812	32,5 x 19	4,5



Tablett „BAMBOO“

tray
bandeja
plateau



	cm	↑ cm
84813	40 x 25,5	3,0
84814	53 x 34,0	3,5



Tablett „BAMBOO“

tray
bandeja
plateau

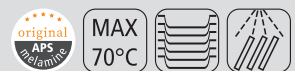

	cm	↑ cm
84810	34 x 13	3



LOOPS

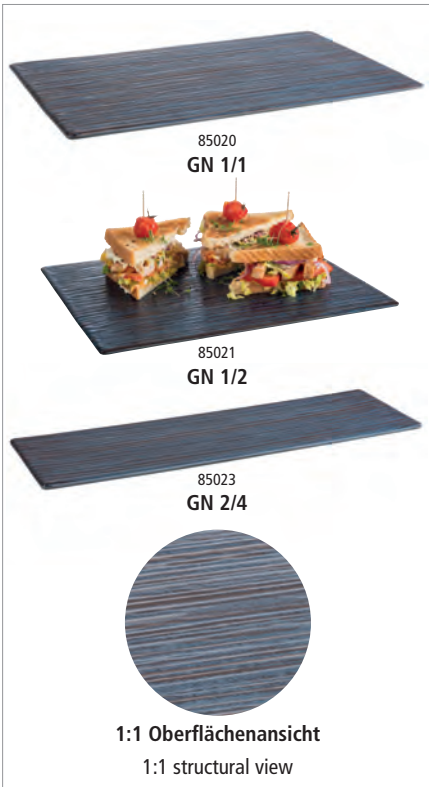

GN Tablett „LOOPS“

GN tray
GN bandeja
GN plateau



	cm	↑ cm	GN
85020	53,0 x 32,5	1,5	1/1
85021	32,5 x 26,5	1,5	1/2
85022	32,5 x 17,6	1,5	1/3
85023	53,0 x 16,2	1,5	2/4



Tablett/Sushiboard „LOOPS“

tray
bandeja
plateau



	cm	↑ cm
85025	23,5 x 13,5	1,5



Teller „LOOPS“

plate
plato
assiette



	Ø cm	↑ cm
85027	22	2
85028	27	2



Schale „LOOPS“

bowl
cuenco
bol



	∅ cm	↑ cm	ltr.
85024	34 x 15,5	4	0,6



Schale „LOOPS“

bowl
cuenco
bol



	∅ cm	↑ cm	ltr.
85026	18	3	0,25



Schale „LOOPS“

bowl
cuenco
bol



	∅ cm	↑ cm	ltr.
85029	20,5	6,5	0,8
85030	31,0	8,0	2,0



Tablett „LOOPS“

tray
bandeja
plateau



	∅ cm	↑ cm
85031	32,0	3,5
85032	40,5	5,0



Torten- / Konditorplatte „LOOPS“

cake stand
soporte para pastel
présentoir à gâteaux



	∅ cm	↑ cm	fits to
85033	21,5	2,5	06519
85034	30,5	3,5	06520, 06512, 06510
85035	37,5	4,0	06521

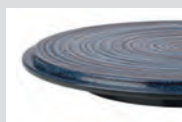

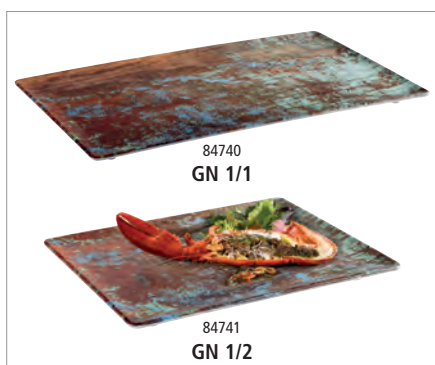

GN Tablett „AQUARIS“

GN tray
GN bandeja
GN plateau



	cm	↑ cm	GN	Farbe / Colour
84740	53,0 x 32,5	2	1/1	
84741	32,5 x 26,5	2	1/2	
84742	32,5 x 17,6	2	1/3	
84743	53,0 x 16,2	2	2/4	

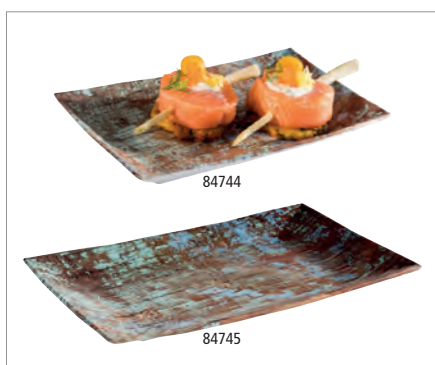

Tablett „AQUARIS“

tray
bandeja
plateau



	cm	↑ cm	Farbe / Colour
84744	21,0 x 13	3	
84745	34,5 x 22	3	

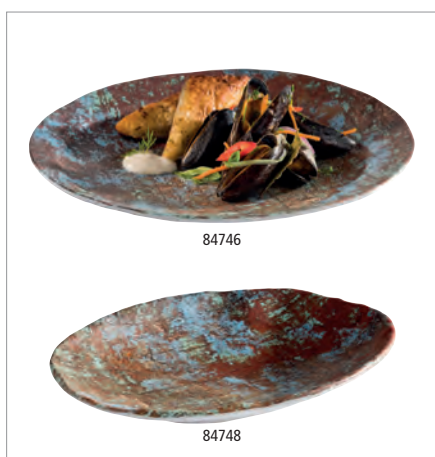

Teller „AQUARIS“

plate
plato
assiette



	Ø cm	↑ cm	Farbe / Colour
84746	26	3,5	
84747	35	3,0	

	cm	↑ cm	Farbe / Colour
84748	24,0 x 17	3,5	
84749	40,5 x 30	4,0	



Schale „COCONUT“

bowl
cuenco
bol



	∅ cm	↑ cm	litr.
84990	14	6,5	0,5
84991	24	9,5	2,2



1:1 Oberflächenansicht
1:1 structural view



Schale „ELEMENT LOOK“

bowl
cuenco
bol



	∅ cm	↑ cm	litr.
84835	21,5	5,5 / 9,5	0,7
84836	26,0	7,0 / 12,5	1,45
84837	30,0	8,5 / 14,5	2,3



1,45 ltr.

84836



mit Antirutschfüßchen
with non-slip feet
con pies antideslizantes
avec pieds antidérapants



GN Tablett „IRON“

GN tray
GN bandeja
GN plateau



	cm	↑ cm	GN
84884	32,5 x 26,5	2	1/2
84885	26,5 x 16,2	2	1/4
84886	53,0 x 16,2	2	2/4



Schale „IRON“

GN bowl
GN cuenco
GN bol



	cm	↑ cm	GN	litr.
84880	32,5 x 26,5	8,5	1/2	3,5
84881	26,5 x 16,2	8,5	1/4	1,4
84882	53,0 x 16,2	8,5	2/4	3,2
84883	25,0 x 25,0	10,0	-	2,8



STONE ART



84511

Teller „STONE ART“
plate
plato
assiette



	Ø cm	↑ cm
84510	19	2
84511	25	2
84512	30	2



84509

Teller „STONE ART“
plate
plato
assiette



	Ø cm	↑ cm	litr.
84509	15,5	2,5	0,15
84514	20,0	4,5	0,60



Teller „STONE ART“
plate
plato
assiette



	Ø cm	↑ cm
84515	24,5	3,5



Teller „STONE ART“
plate
plato
assiette



	cm	↑ cm
84517	33 x 32,5	3

STONE ART



Schale „STONE ART“

bowl
cuenco
bol



MAX
70°C



	∅ cm	↑ cm	ltr.
84523	8	3	0,07



Schale „STONE ART“

bowl
cuenco
bol



MAX
70°C



	∅ cm	↑ cm	ltr.
84524	12	6	0,3



Schale „STONE ART“

bowl
cuenco
bol



MAX
70°C



	∅ cm	↑ cm	ltr.
84525	15	7,5	0,6



Schale „STONE ART“

bowl
cuenco
bol



MAX
70°C



	cm	↑ cm	ltr.
84526	23 x 19	6,5	0,6



Schale „STONE ART“

bowl
cuenco
bol



MAX
70°C



	cm	↑ cm	ltr.
84528	28,5 x 21	7,5	1,2



84529

Schale „STONE ART“

bowl
cuenco
bol



MAX
70°C



	cm	↑ cm	ltr.
84529	19 x 19	6,0	0,5
84530	24 x 24	6,5	1,1



GN Tablett „STONE ART“

GN tray
GN bandeja
GN plateau



	cm	↑ cm	GN
84519	53,0 x 32,5	1,5	1/1
84520	32,5 x 26,5	1,5	1/2
84522	53,0 x 16,2	1,5	2/4
84521	32,5 x 17,6	1,5	1/3



mit Antirutschfüßchen
with non-slip feet
con pies antideslizantes
avec pieds antidérapants



GN Abdeckhaube

GN cover
GN cubierta
GN cloche



passend für GN Tablett, glasklarer Kunststoff, nahezu unzerbrechlich
suitable for GN trays, clear plastic, nearly unbreakable
apto para bandejas GN, plástico transparente, muy resistente a la rotura
pour bacs et plateaux GN, plastique transparent, très résistant à la casse

	cm	↑ cm	✱ mm	GN
11043	32,5 x 17,6	10,5	3	1/3
11044	53,0 x 16,2	10,5	3	2/4

	cm	↑ cm	✱ mm	GN
11041	32,5 x 26,5	9,5	3	1/2
11042	53,0 x 32,5	9,5	3	1/1

AIKO



Schale „AIKO“

bowl
cuenco
bol



Steinoptik

appearance stoneware
su aspecto recuerda al gres
l'aspect de la mélamine rapelle le grès

	cm	↑ cm	ltr.	Farbe / Colour
84327	26,5 x 19,5	6	0,9	■



84331

Schale „AIKO“

bowl
cuenco
bol



Steinoptik

appearance stoneware
su aspecto recuerda al gres
l'aspect de la mélamine rapelle le grès

	Ø cm	↑ cm	ltr.	Farbe / Colour
84329	8,0	4	0,07	■
84331	11,5	6	0,20	■



84334

84337

Schale „AIKO“

bowl
cuenco
bol



Steinoptik

appearance stoneware
su aspecto recuerda al gres
l'aspect de la mélamine rapelle le grès

	Ø cm	↑ cm	ltr.	Farbe / Colour
84334	16,0	7	0,6	■
84336	20,5	8	1,2	■
	Ø cm	↑ cm	ltr.	Farbe / Colour
84335	16,0	7	0,6	■
84337	20,5	8	1,2	■



Betonoberflächen auf dem Buffet für den Kontakt mit Lebensmitteln? ELEMENT macht es möglich. Bestens geeignet im modernen und urbanen Ausstattungsumfeld.

Concrete surfaces on the buffet for food contact? ELEMENT makes it possible. Ideally suited for modern and urban environments.

¿Superficies de hormigón en el buffet y tener contacto con alimentos? ELEMENT lo hace posible. Ideal para ambientes modernos y urbanos.

Des surfaces en béton sur le buffet et destinées au contact alimentaire? ELEMENT le rend possible. Idéal pour les environnements modernes et urbains.



Schale „ELEMENT“

bowl
cuenco
bol



	cm	↑ cm	ltr.
84825	∅ 8,0	2,0	0,01
84826	10,5 x 10,0	3,0	0,02
84820	9,0 x 7,0	3,0	0,03
84821	10,5 x 10,5	3,0	0,04
84827	17,5 x 15,5	5,5	0,18



Tablett „ELEMENT“

tray
bandeja
plateau



	cm	↑ cm
84822	20 x 9,5	2,5



Tablett „ELEMENT“

tray
bandeja
plateau



	cm	↑ cm
84824	31 x 10,5	1,5



Tablett „ELEMENT“

tray
bandeja
plateau



	cm	↑ cm
84823	22,5 x 15	3



Schale „ELEMENT“

bowl
cuenco
bol



	Ø cm	↑ cm	ltr.
84828	16	7	0,5
84829	28	12	3,0



Schale „ELEMENT“

bowl
cuenco
bol



	cm	↑ cm	ltr.
84830	19 x 19	9	1,5
84831	25 x 25	12	3,8



GN Tablett „ELEMENT“

GN tray
GN bandeja
GN plateau



	cm	↑ cm	GN
84400	53,0 x 32,5	3,5	1/1
84401	32,5 x 26,5	3,5	1/2
84402	32,5 x 17,5	3,5	1/3
84403	26,5 x 16,2	3,5	1/4
84404	53,0 x 16,2	3,5	2/4



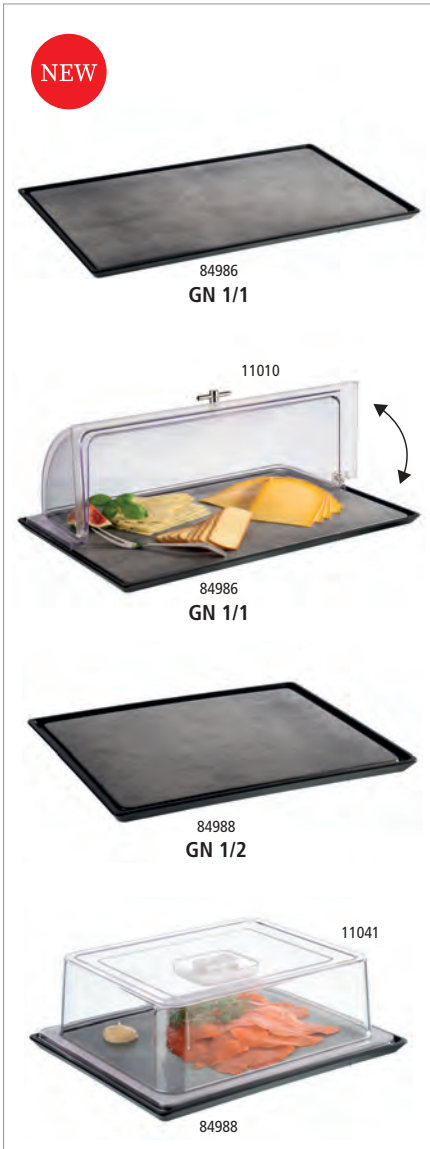

GN Tablett „ELEMENT“

GN tray
GN bandeja
GN plateau



	cm	↑ cm	GN
84986	53,0 x 32,5	1,5	1/1
84988	35,5 x 29,0	1,5	1/2

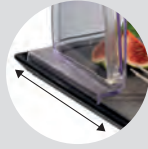

mit Antirutschrinne für Hauben
with non-slip groove for covers

passende Hauben / suitable for cover / aptas para campana / convient pour cloche

	cm	↑ cm	GN
11010	53,0 x 32,5	19	1/1
11027	53,0 x 32,5	9,5	1/1
11041	32,5 x 26,5	9,5	1/2
11021	33,0 x 28,0	17	1/2

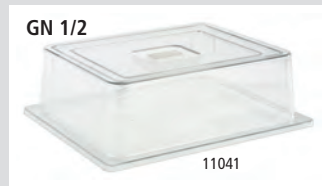
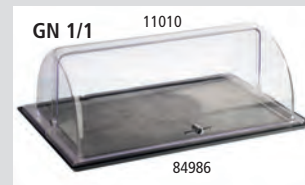

GN Tablett „BUFFET PRO“

GN tray
GN bandeja
GN plateau



mit Mulde für Besteckablage
with tray for cutlery storage
con espacio reposa cubiertos
avec espace repose-ustensiles

	cm	↑ cm	GN
85145	53,0 x 32,5	1,5	1/1
85146	32,5 x 26,5	1,5	1/2



mit Mulde für Vorlagegabel
with tray for cutlery storage



Präsentationsmöglichkeit
presentation example

TIMBER



Teller „TIMBER“

plate
plato
assiette



	Ø cm	↑ cm
84890	15	1,5



Teller „TIMBER“

plate
plato
assiette



	Ø cm	↑ cm
84891	21,5	2,5
84892	27,5	3,0



Tablett „TIMBER“

tray
bandeja
plateau



	Ø cm	↑ cm
84266	35	3
84267	44	3



Tablett „TIMBER“

tray
bandeja
plateau



	cm	↑ cm
84268	44 x 25	1,5



Tablett „TIMBER“

tray
bandeja
plateau



	cm	↑ cm
84269	65 x 26	3



Tablett „TIMBER“

tray
bandeja
plateau



	cm	↑ cm
84256	70 x 26	3

OAK



Schale „OAK“

bowl
cuenco
bol



	cm	↑ cm
84434	11,5 x 7,0	2,5
84435	25,0 x 6,5	3,5



GN Tablett „OAK“

GN tray
GN bandeja
GN plateau



Eichenoptik

oak wood effect
imitación madera de roble
imitation chêne

	cm	↑ cm	GN
84720	53,0 x 32,5	1	1/1
84721	32,5 x 26,5	1	1/2
84722	32,5 x 17,6	1	1/3
84723	26,5 x 16,2	1	1/4
84724	53,0 x 16,2	1	2/4



Tablett „OAK“

tray
bandeja
plateau



	Ø cm	↑ cm	Griff / handle cm
84177	30	1,5	12



Tablett „OAK“

tray
bandeja
plateau



	cm	↑ cm	GN
84178	40 x 20	1,5	13
84179	48 x 20	1,5	13





OAK LIGHT



GN Tablett „OAK LIGHT“

GN tray
GN bandeja
GN plateau



	cm	↑ cm	GN
84205	53,0 x 32,5	1,5	1/1
84206	32,5 x 26,5	1,5	1/2
84207	32,5 x 17,6	1,5	1/3
84208	26,5 x 16,2	1,5	1/4
84209	53,0 x 16,2	1,5	2/4



Holzoptik Eiche hell
wood look oak light



mit Antirutschfüßchen
with non-slip feet



Tablett „OAK LIGHT“

tray
bandeja
plateau



	∅ cm	↑ cm
84262	35	3
84263	44	3



Tablett „OAK LIGHT“

tray
bandeja
plateau



	cm	↑ cm
84264	44 x 25	1,5



Tablett „OAK LIGHT“

tray
bandeja
plateau



	cm	↑ cm
84265	65 x 26	3

GLAMOUR



Schale „GLAMOUR“
bowl
cuenco
bol



	Ø cm	↑ cm	ltr.
84365	8	3	0,05



Schale „GLAMOUR“
bowl
cuenco
bol



	Ø cm	↑ cm	ltr.
84366	12	5	0,25



Schale „GLAMOUR“
bowl
cuenco
bol



	Ø cm	↑ cm	ltr.
84367	15	8	0,70



Tablett „GLAMOUR“
tray
bandeja
plateau



	cm	↑ cm
84377	22 x 12	3,0
84378	37 x 11	2,5



Tablett „GLAMOUR“
tray
bandeja
plateau



	cm	↑ cm
84380	25,0 x 15,5	1,5
84381	30,5 x 19,0	1,5



Tablett „GLAMOUR“
tray
bandeja
plateau



	cm	↑ cm
84379	30 x 11	3

CROCKER



Servier- und Buffetartikel in Tonoptik, brauner Rand. Die Oberfläche ist innen und außen fein-matt, fühlt sich an wie Ton.

Serving and buffet items, an imitation of clay, with a brown border. The surface is inside and outside fine-matt. Feels like real clay.

Artículos de servicio y buffet, imitación barro y con borde marrón. La superficie de dentro y de fuera es de deslustre fino. Parece barro natural.

Pièces de service et pour le buffet imitation argile avec bord marron. La surface est à l'intérieur et à l'extérieur bien-matte.



Teller „CROCKER“

plate
plato
assiette



	cm	↑ cm	Farbe / Colour
84567	14 x 13	2,5	
84568	14 x 13	2,5	



Teller „CROCKER“

plate
plato
assiette



	Ø cm	↑ cm	ltr.	Farbe / Colour
84575	20,5	3	0,50	
84576	20,5	3	0,50	



Schale „CROCKER“

bowl
cuenco
bol



	Ø cm	↑ cm	ltr.	Farbe / Colour
84573	16,5	4	0,50	
84574	16,5	4	0,50	



Schale „CROCKER“

bowl
cuenco
bol



	Ø cm	↑ cm	ltr.	Farbe / Colour
84569	12,5	6	0,37	
84570	12,5	6	0,37	
84571	16,0	7	0,70	
84572	16,0	7	0,70	
84577	21,0	8	1,45	
84578	21,0	8	1,45	



Blattschale „CROCKER“

leaf
fuente en forma de hoja
plateau feuille



	cm	↑ cm	ltr.	Farbe / Colour
84579	30,5 x 10	7,5	0,17	
84580	30,5 x 10	7,5	0,17	
84581	42 x 14	9,5	0,65	
84582	42 x 14	9,5	0,65	

FRIDA

FRIDA'S BREAKFAST



FRIDA

FRIDA'S HEALTHY BUFFET





Schale „FRIDA LOCK“

bowl
cuenco
bol



Schalen lassen sich durch Drehmechanismus mit dem Ständer fest verbinden

bowls can be firmly connected to the stand by a turning mechanism

los cuencos se pueden conectar firmemente al soporte mediante un mecanismo giratorio

les bols peuvent être solidement reliés au présentoir au moyen d'un mécanisme rotatif

	Ø cm	↑ cm	ltr.	Farbe / Colour
84920	21,5	7/8,5	1,0	
84921	21,5	7/8,5	1,0	
84922	25,0	8/11	1,6	
84923	25,0	8/11	1,6	
84924	28,5	10/14	2,6	
84925	28,5	10/14	2,6	



Haube

cover
campana
cloche



	Ø cm	↑ cm	fits to
06519	21	17	84941, 84942
06520	30	22	84943, 84944
06521	36	27	84945, 84946

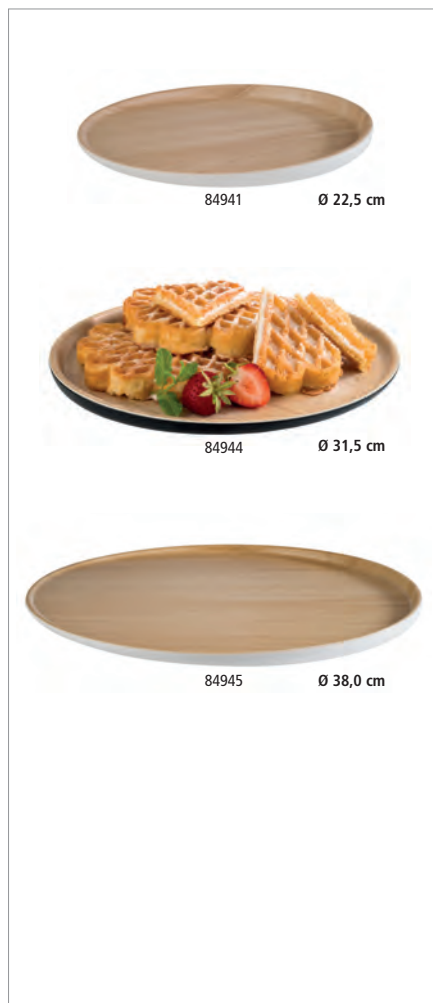

Tablett / Platte „FRIDA LOCK“

tray
bandeja
plateau



Tabletts lassen sich durch Drehmechanismus mit dem Ständer fest verbinden

trays can be firmly connected to the stand by a turning mechanism

las bandejas se pueden conectar firmemente al soporte mediante un mecanismo giratorio

les plateaux peuvent être solidement reliés au présentoir au moyen d'un mécanisme rotatif

	Ø cm	↑ cm	Farbe / Colour
84941	22,5	1,5/2,5	
84942	22,5	1,5/2,5	
84943	31,5	1,5/2,5	
84944	31,5	1,5/2,5	
84945	38,0	1,5/2,5	
84946	38,0	1,5/2,5	



Ständer „FRIDA LOCK“

stand
soporte
présentoir



	Ø cm	↑ cm	Farbe / Colour
84926	16,5	8	
84927	16,5	8	



	Ø cm	↑ cm	Farbe / Colour
84928	16,5	12	
84929	16,5	12	



FRIDA



Auf der kurzen und der langen Seite aufstellbar!
 Can stay on the short or long side!
 Se puede colocar por la parte corta o larga!
 Se peut installer sur le côté court ou long!

GN Buffetständer
 GN buffet stand
 GN soporte para buffet
 GN présentoir buffet



	cm	GN	Farbe / Colour
15504	53,0 x 32,5 / 53,0 x 16,2	1/1 / 2/4	■
15505	32,5 x 26,5 / 26,5 x 16,2	1/2 / 1/4	■



GN Tablett „FRIDA“
 GN tray
 GN bandeja
 GN plateau



	cm	↑ cm	GN
84601	53,0 x 32,5	2	1/1
84602	32,5 x 26,5	2	1/2
84603	26,5 x 16,2	2	1/4
84604	53,0 x 16,2	2	2/4



mit Antirutschfüßchen
 with non-slip feet
 con pies antideslizantes
 avec pieds antidérapants

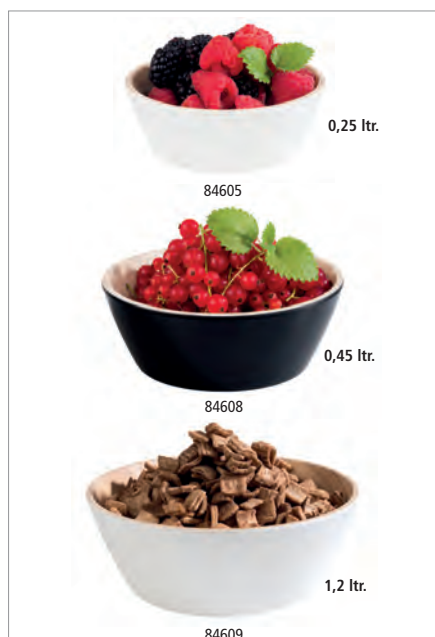

Schale „FRIDA“

bowl
cuenco
bol

	Ø cm	↑ cm	ltr.	Farbe / Colour
84605	12,5	4,5	0,25	
84606	12,5	4,5	0,25	
84607	15,0	5,5	0,44	
84608	15,0	5,5	0,44	
84609	20,0	7,5	1,20	
84610	20,0	7,5	1,20	



Schale „FRIDA“

bowl
cuenco
bol

	Ø cm	↑ cm	ltr.	Farbe / Colour
84611	22,0	10,5	2,2	
84612	22,0	10,5	2,2	
84613	26,5	10,5	3,4	
84614	26,5	10,5	3,4	



mit Antirutschfüßchen
with non-slip feet
con pies antideslizantes
avec pieds antidérapants



Tablett „FRIDA“

tray
bandeja
plateau

	cm	↑ cm	Farbe / Colour
84650	21,5 x 10,0	2,0	
84651	21,5 x 10,0	2,0	
84652	27,0 x 12,0	2,5	
84653	27,0 x 12,0	2,5	
84654	36,0 x 16,5	3,0	
84655	36,0 x 16,5	3,0	



Schale „FRIDA“

bowl
cuenco
bol

	cm	↑ cm	Farbe / Colour
84615	32 x 25	3,5	
84616	32 x 25	3,5	



Schale „FRIDA“

bowl
cuenco
bol



	Ø cm	↑ cm	ltr.	Farbe / Colour
84930	8,5	3,5	0,1	White/Yellow
84931	8,5	3,5	0,1	Black/Yellow
84932	21,5	7,5	1,8	White/Yellow
84933	21,5	7,5	1,8	Black/Yellow
84934	30,0	9,5	4,7	White/Yellow
84935	30,0	9,5	4,7	Black/Yellow



Schale „FRIDA“

bowl
cuenco
bol



	cm	↑ cm	ltr.	Farbe / Colour
84936	12,5 x 12,5	4,5	0,37	White/Yellow
84937	12,5 x 12,5	4,5	0,37	Black/Yellow



Tablett „FRIDA“

tray
bandeja
plateau



mit 3 Absätzen, Ø 5,4 cm
with 3 holes, Ø 5,4 cm
con 3 agujeros, Ø 5,4 cm
avec 3 trous, Ø 5,4 cm

	cm	↑ cm	Farbe / Colour
84938	30 x 8,5	1	White/Yellow

Anwendungsbeispiel mit Weck-Glas Nr. 82312
example of use with Weck-glasses no. 82312

**Servierset „FRIDA“, 4-tlg.**

serving set, 4 pcs. set
set de servicio, set de 4
set de service, set de 4

**4-teiliges Set, bestehend aus 1 Tablett mit 3 Schalen**

4 pcs set, consisting of 1 tray with 3 bowls
set de 4, compuesto por 1 bandeja con 3 cuencos
set de 4, composé d'un plateau avec 3 bols

	cm	↑ cm	Farbe / Colour
84939	30 x 8,5	4,5	
84940	30 x 8,5	4,5	

**GN 1/9 Schale „FRIDA“**

GN 1/9 bowl
GN 1/9 cuenco
GN 1/9 bol



	Ø cm	↑ cm	ltr.	GN	Farbe / Colour
84555	17,6 x 10,8	5,5	1,5	1/9	
84556	17,6 x 10,8	5,5	1,5	1/9	

**GN 1/6 Schale „FRIDA“**

GN 1/6 bowl
GN 1/6 cuenco
GN 1/6 bol



	Ø cm	↑ cm	ltr.	GN	Farbe / Colour
84583	17,6 x 16,2	7,5	1,0	1/6	
84584	17,6 x 16,2	7,5	1,0	1/6	

**GN 1/4 Schale „FRIDA“**

GN 1/4 bowl
GN 1/4 cuenco
GN 1/4 bol



	Ø cm	↑ cm	ltr.	GN	Farbe / Colour
84586	26,5 x 16,2	7,5	1,8	1/4	
84587	26,5 x 16,2	7,5	1,8	1/4	

**GN 2/4 Schale „FRIDA“**

GN 2/4 bowl
GN 2/4 cuenco
GN 2/4 bol



	Ø cm	↑ cm	ltr.	GN	Farbe / Colour
84564	53 x 16,2	7,5	3,65	2/4	
84565	53 x 16,2	7,5	3,65	2/4	

**GN 1/2 Schale „FRIDA“**

GN 1/2 bowl
GN 1/2 cuenco
GN 1/2 bol



	Ø cm	↑ cm	ltr.	GN	Farbe / Colour
84589	32,5 x 26,5	7,5	4,0	1/2	
84590	32,5 x 26,5	7,5	4,0	1/2	



Schale „FRIDA“
bowl
cuenco
bol

original
APS
melamine

MAX
70°C

	cm	↑ cm	ltr.	Farbe / Colour
84947	33,5 x 21	4	1,2	White/Yellow
84948	33,5 x 21	4	1,2	Black/Yellow

als Schütte geeignet
suitable as a chute

Präsentationsmöglichkeit
presentation example



Schale „FRIDA“
bowl
cuenco
bol

original
APS
melamine

MAX
70°C

	cm	↑ cm	ltr.	Farbe / Colour
84558	16,5 x 16,5	5,5	0,85	White/Yellow
84559	16,5 x 16,5	5,5	0,85	Black/Yellow



Schale „FRIDA“
bowl
cuenco
bol

original
APS
melamine

MAX
70°C

	cm	↑ cm	ltr.	Farbe / Colour
84561	25 x 25	7,5	2,65	White/Yellow
84562	25 x 25	7,5	2,65	Black/Yellow



Schale „FRIDA“
bowl
cuenco
bol

original
APS
melamine

MAX
70°C

	cm	↑ cm	ltr.	Farbe / Colour
84592	25 x 25	12	3,5	White/Yellow
84593	25 x 25	12	3,5	Black/Yellow

SAN
KUNSTSTOFF

Deckel „PURE“ mit Löffelaussparung / cover with notched for spoons / tapa con espacio para la cuchara / couvercle avec encoche pour la louche

	cm	↑ cm	fits to
83601	25 x 25	1,5	84561, 84562, 84592, 84593

NEW

84987
GN 1/284985
GN 1/184985
GN 1/1

GN Tablett „FRIDA“

GN tray
GN bandeja
GN plateau

	cm	↑ cm	GN	Farbe / Colour
84987	35,5 x 29,0	1,5	1/2	
84985	53,0 x 32,5	1,5	1/1	

11021
84987
GN 1/2
Präsentationsmöglichkeit
presentation example11010
84985
GN 1/1

passende Hauben / suitable for cover / aptas para campana / convient pour cloche

	cm	↑ cm	GN
11010	53,0 x 32,5	19,0	1/1
11042	53,0 x 32,5	9,5	1/1
11021	33,0 x 28,0	17,0	1/2

mit Antirutschrinne für Hauben
with non-slip groove for covers

84595

GN 1/4 Tablett „FRIDA“

GN 1/4 tray
GN 1/4 bandeja
GN 1/4 plateau

	cm	↑ cm	Farbe / Colour
84595	26,5 x 16,2	3	
84596	26,5 x 16,2	3	



84599

Tablett „FRIDA“

tray
bandeja
plateau

	cm	↑ cm	Farbe / Colour
84598	35,5 x 26,0	3	
84599	35,5 x 26,0	3	

SLATE



Die schwarzen Melaminplatten überzeugen mit ihrem edlen und schlichten Schieferlook und einer rauhen Oberfläche.

The black melamine trays convince with their noble and simple slate look and a rough surface.

Las bandejas de melamina negras convencen por su aspecto de pizarra elegante y discreto y una superficie áspera.

Les plateaux en mélamine noirs convainquent grâce au aspect de l'ardoise élégant et discret et une surface rugueuse.



GN Tablett „SLATE“

GN tray
GN bandeja
GN plateau



	cm	↑ cm	GN
83955	53,0 x 32,5	1	1/1
83956	32,5 x 26,5	1	1/2
83957	32,5 x 17,6	1	1/3
83958	26,5 x 16,2	1	1/4
83971	53,0 x 16,2	1	2/4



GN Tablett „SLATE“

GN tray
GN bandeja
GN plateau



	cm	↑ cm	GN
83981	53 x 32,5	1,5	1/1



GN Tablett „SLATE“

GN tray
GN bandeja
GN plateau



massive Metallgriffe verchromt inkl. fest verschraubten 4 cm Distanzstücken
chrome plated handles, incl. mounted 4 cm distance pillars
asas cromadas, incluye distanciadores a 4 cm
poignées chromées, distance approx. 4 cm

	cm	↑ cm	GN
83980	53 x 32,5	6	1/1



Torten- / Konditorplatte „SLATE“

cake stand
soporte para pastel
présentoir à gâteaux



Rand fixiert die Haube, mit Antirutsch-Füßchen

carved edge fixes the cover, with non-slip feet

ranura para fijar bien la campana, con pies antideslizantes

bord rainuré pour maintenir ferme la cloche, avec pieds antidérapants

	Ø cm	↑ cm
85046	21,5	2,5
85047	30,5	3,5
85048	37,5	4

Frischhalte- Haube / cover / campana / cloche

	Ø cm	↑ cm	fits to
06519	21	17	85046
06520	30	22	85047
06521	36	27	85048

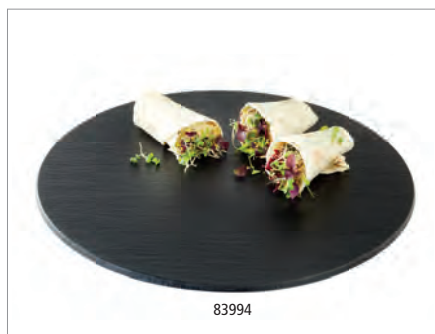

Tablett „SLATE“

tray
bandeja
plateau



	Ø cm	↑ cm
83992	30	1
83994	40	1



Schale „SLATE“

bowl
cuenco
bol



	cm	↑ cm	ltr.
84244	19 x 19	9	1,5
84245	25 x 25	12	3,8

Deckel „PURE“ mit Löffelaussparung / cover with notched for spoons

tapa con espacio para la cuchara / couvercle avec encoche pour la louche

	cm	↑ cm	fits to
83600	19 x 19	1,5	84244
83601	25 x 25	1,5	84245

SLATE ROCK



Tablett „SLATE-ROCK“

tray
bandeja
plateau



Die schwarzen Melaminplatten überzeugen mit ihrem Schieferlook
 The black melamine trays convince with their slate look
 Las bandejas de melamina negras convencen por su aspecto de pizarra
 Les plateaux en mélamine noirs convainquent grâce au aspect de l'ardoise

	Ø cm	↑ cm	Griff / handle cm
84257	30	1,5	12
	cm	↑ cm	Griff / handle cm
84258	40 x 20	1,5	13
84259	48 x 20	1,5	13



GN Tablett „ZERO“

GN tray
GN bandeja
GN plateau



glatte, hochglänzende Oberfläche
smooth and shiny surface
superficie lisa con acabado brillante
surface lisse et finition brillante

	cm	↑ cm	GN	Farbe / Colour
84185	53,0 x 32,5	1,5	1/1	
84186	32,5 x 26,5	1,5	1/2	
84187	32,5 x 17,6	1,5	1/3	
84188	26,5 x 16,2	1,5	1/4	
84189	53,0 x 16,2	1,5	2/4	
84195	53,0 x 32,5	1,5	1/1	
84196	32,5 x 26,5	1,5	1/2	
84197	32,5 x 17,6	1,5	1/3	
84198	26,5 x 16,2	1,5	1/4	
84199	53,0 x 16,2	1,5	2/4	



GN Tablett „DRIFTWOOD“

GN tray
GN bandeja
GN plateau



die Melaminplatten (Holzoptik) haben eine leicht wellige Oberfläche und wirken optisch wie aus Holz gefertigt
the melamine trays (wood look) have a slightly wavy surface and look visually as made of natural wood
las bandejas de melamine (imitación madera) tienen una superficie ligeramente ondulada y parecen estar hechas de madera natural
les plateaux de mélamine (imitation bois) ont une surface légèrement ondulée et donnent une impression visuelle de bois naturelle

	cm	↑ cm	GN
84180	53,0 x 32,5	1,5	1/1
84181	32,5 x 26,5	1,5	1/2
84182	32,5 x 17,6	1,5	1/3
84183	26,5 x 16,2	1,5	1/4
84184	53,0 x 16,2	1,5	2/4



1:1 Oberflächenansicht
1:1 structural view



CIRCLE



Tablett „CIRCLE“
plate / tray
plato / bandeja
assiette / plateau



	∅ cm	↑ cm	Farbe / Colour
84875	32,0	3,5	
84876	40,5	5,5	



LA VIDA

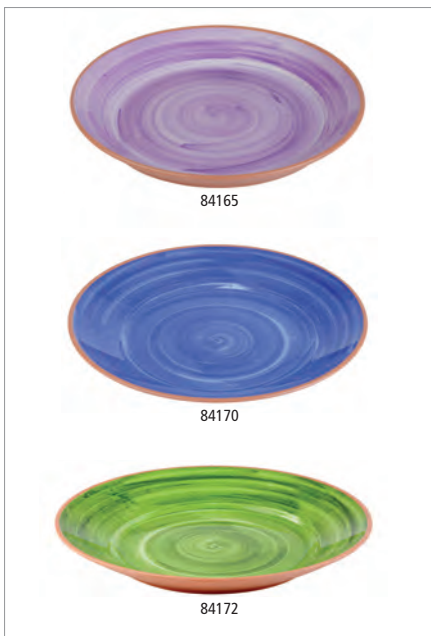

Tablett „LA VIDA“
plate / tray
plato / bandeja
assiette / plateau



	∅ cm	↑ cm	Farbe / Colour
84165	32,0	3,5	
84168	40,5	5,5	

	∅ cm	↑ cm	Farbe / Colour
84161	32,0	3,5	
84170	40,5	5,5	

	∅ cm	↑ cm	Farbe / Colour
84171	32,0	3,5	
84172	40,5	5,5	



MARONE

Eine derbe Oberflächenstruktur schafft ein natürliches Erscheinungsbild. Die schwarzen Schalenvarianten mit braunem Rand inszenieren Ihr Gericht sehr stilvoll.

A rough surface structure creates a natural appearance. The black bowls and trays with brown border stage your dishes in a very stylish way.

La estructura rugosa de la superficie crea una apariencia natural. Los diferentes cuencos negros con borde marrón ponen con mucho estilo en escena sus platos.

La structure de surface rugueuse crée une apparence naturelle. Les différents bols noirs avec rebord marron mettent élégamment en scène vos plats.



Blattschale „MARONE“

leaf
fuente en forma de hoja
plateau feuille



	cm	↑ cm	ltr.
84100	25,5 x 14	5,5	0,4
84101	36,0 x 19	8,0	0,9



Tablett „MARONE“

tray
bandeja
plateau



	cm	↑ cm
84104	22,5 x 15	3
84105	27,5 x 11	2



Tablett „MARONE“

tray
bandeja
plateau



	cm	↑ cm
84103	14,5 x 14,5	2



Tablett „MARONE“

tray
bandeja
plateau



	cm	↑ cm
84106	26,5 x 16,5	4

MARONE



Schale „MARONE“

bowl
cuenco
bol



	cm	↑ cm	ltr.
84731	16,5 x 10	5,5	0,25
84732	22,0 x 13	7,5	0,6
84733	27,5 x 19	9,0	1,4



Teller „MARONE“

plate
plato
assiette



	Ø cm	↑ cm
84728	16,0	2,5
84729	20,5	2,5
84730	28,0	3,5



Schale „MARONE“

bowl
cuenco
bol



	Ø cm	↑ cm	ltr.
84109	11	5,5	0,2



Schale „MARONE“

bowl
cuenco
bol



	Ø cm	↑ cm	ltr.
84107	8,5	2,5	0,05
84108	11,5	3,0	0,04



Tablett „MARONE“

tray
bandeja
plateau



	cm	↑ cm
84117	19,5 x 9,5	2
84118	39,0 x 16,0	3



Tablett „MARONE“

tray
bandeja
plateau



	cm	↑ cm
84119	32,5 x 23,5	4,5



Schale „MARONE“

bowl
cuenco
bol



	Ø cm	↑ cm	ltr.
84174	30,5	8,5	2



Schale „MARONE“

bowl
cuenco
bol



	Ø cm	↑ cm	ltr.
84110	14	6,0	0,30
84111	19	8,0	0,80
84112	21	8,5	1,00
84113	24	9,5	1,40



Schale „MARONE“

bowl
cuenco
bol



	cm	↑ cm	ltr.
84114	23,5 x 23,5	6,5	0,70



Schale „MARONE“

bowl
cuenco
bol



	Ø cm	↑ cm	ltr.
84115	11	3,5	0,13
84116	14	4,0	0,20

DARK WAVE



GN Tablett „DARK WAVE“

GN tray
GN bandeja
GN plateau



	cm	↑ cm	GN
84900	53,0 x 32,5	2	1/1
84901	32,5 x 26,5	2	1/2
84902	32,5 x 17,6	2	1/3
84903	53,0 x 16,2	2	2/4



Tablett „DARK WAVE“

tray
bandeja
plateau



	cm	↑ cm
84904	14 x 14	2



Tablett „DARK WAVE“

tray
bandeja
plateau



	cm	↑ cm
84905	23 x 10,5	1,5
84906	29 x 12,0	1,5

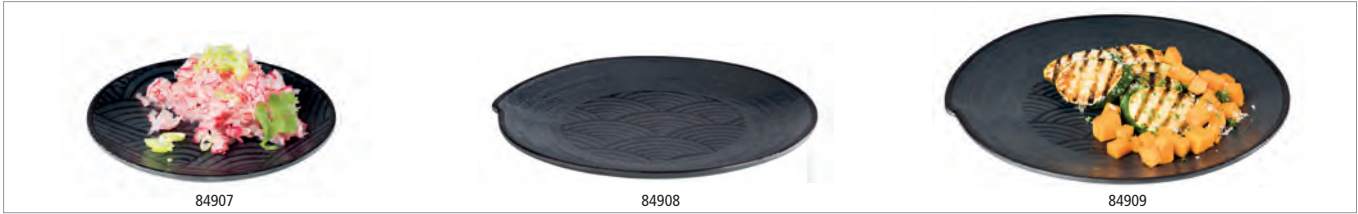

Teller „DARK WAVE“

plate
plato
assiette



	Ø cm	↑ cm
84907	14,5	1,5
84908	22,0	2,0
84909	27,0	2,5



Schale „DARK WAVE“

bowl
cuenco
bol



	Ø cm	↑ cm	litr.
84910	17,5	5,0	0,50
84911	22,5	5,0	0,75
84912	32,0	3,5	–
84913	40,5	5,5	–



Schale „DARK WAVE“

bowl
cuenco
bol



	cm	↑ cm	litr.
84914	18 x 18	10,0	1,6
84915	23 x 23	11,5	2,9

ZEN



Fernöstliche Tisch- und Buffetartikel präsentiert die Serie ZEN. Die Optik entspricht dem japanischen Steingut.

The ZEN series presents Far Eastern table and buffet articles. The appearance is that of Japanese stoneware.

La colección ZEN presenta artículos de buffet y mesa para la cocina oriental. Su aspecto recuerda al gres japonés.

La collection ZEN présente des articles de buffet et de table pour la cuisine orientale. L'aspect de la mélamine rappelle le grès japonais.



Schale „ZEN“
bowl
cuenco
bol



	Ø cm	↑ cm	ltr	Farbe / Colour
83929	31	8,5	2,5	■



Schale „ZEN“
bowl
cuenco
bol



	Ø cm	↑ cm	ltr	Farbe / Colour
84355	22,5	12,5	0,80	■



Schale „ZEN“
bowl
cuenco
bol



	cm	↑ cm	ltr	Farbe / Colour
83712	21 x 21	11	1,40	■



Schale „ZEN“

bowl
cuenco
bol

	Ø cm	↑ cm	ltr.	Farbe / Colour
84348	10,0	7,0	0,08	■
84350	12,5	8,5	0,15	■
84352	16,0	10,0	0,30	■
84349	10,0	7,0	0,08	■
84351	12,5	8,5	0,15	■
84353	16,0	10,0	0,30	■

stapelbar
stackable

Schale „ZEN“

bowl
cuenco
bol

	cm	↑ cm	ltr.	Farbe / Colour
83735	25,0 x 13,5	4	0,25	■
83739	30,5 x 17,5	5	0,60	■



Schale „ZEN“

bowl
cuenco
bol

	cm	↑ cm	ltr.	Farbe / Colour
83714	17,5 x 17,5	7	0,5	■
83716	17,5 x 17,5	7	0,5	■



Schale „ZEN“

bowl
cuenco
bol

	cm	↑ cm	ltr.	Farbe / Colour
83725	10,5 x 10,5	3	0,06	■
83727	10,5 x 10,5	3	0,06	■

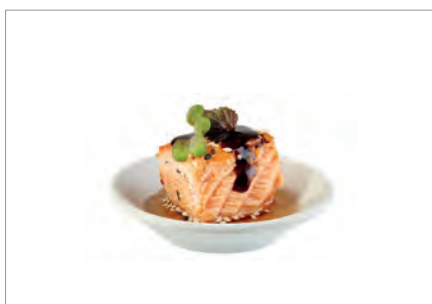

Dipschälchen „ZEN“

dip bowl
cuenco para dip
bol para dip

	Ø cm	↑ cm	ltr.	Farbe / Colour
83721	8	1,5	0,03	■
83723	8	1,5	0,03	■



Schale „ZEN“

bowl
cuenco
bolMAX
70°C

	cm	↑ cm	ltr.	Farbe / Colour
83718	12 x 12	4	0,2	
83720	12 x 12	4	0,2	



Schale „ZEN“

bowl
cuenco
bolMAX
70°C

	cm	↑ cm	ltr.	Farbe / Colour
83726	13 x 11	3,5	0,1	
83728	13 x 11	3,5	0,1	



Schale „ZEN“

bowl
cuenco
bolMAX
70°C

	cm	↑ cm	ltr.	Farbe / Colour
83730	11 x 10	3	0,04	
83732	11 x 10	3	0,04	



Schale „ZEN“

bowl
cuenco
bolMAX
70°C

	cm	↑ cm	ltr.	Farbe / Colour
83722	17,5 x 15,5	5,5	0,2	
83724	17,5 x 15,5	5,5	0,2	



Schale „ZEN“

bowl
cuenco
bolMAX
70°C

	cm	↑ cm	ltr.	Farbe / Colour
83934	14,5 x 12,5	5	0,2	
83935	14,5 x 12,5	5	0,2	



Schale „ZEN“

bowl
cuenco
bolMAX
70°C

	Ø cm	↑ cm	ltr.	Farbe / Colour
83932	11,5	4	0,15	
83933	11,5	4	0,15	



Schale „ZEN“

bowl
cuenco
bol



	cm	↑ cm	ltr.	Farbe / Colour
83946	9 x 7	2,5	0,05	
83947	9 x 7	2,5	0,05	



Schale „ZEN“

bowl
cuenco
bol



	cm	↑ cm	Farbe / Colour
83948	14 x 9	2,5	
83949	14 x 9	2,5	



Tablett / Teller „ZEN“

tray / plate
bandeja / plato
plateau / assiette



	Ø cm	↑ cm	Farbe / Colour
83940	28	3	
83941	28	3	



Tablett „ZEN“

tray
bandeja
plateau



	cm	↑ cm	Farbe / Colour
83734	23,5 x 23	5,5	
83736	23,5 x 23	5,5	



Tablett / Sushiboard „ZEN“

tray / sushiboard
bandeja para sushi
plateau sushi



	cm	↑ cm	Farbe / Colour
83742	22,5 x 9,5	3	
83744	22,5 x 9,5	3	



Tablett / Sushiboard „ZEN“

tray / sushiboard
bandeja para sushi
plateau sushi



	cm	↑ cm	Farbe / Colour
83738	22 x 12	3	
83740	22 x 12	3	

FUSION



Die Oberflächen der Serie FUSION sind innen hoch glänzend und außen mattiert. Das besondere Design beansprucht höchste Aufmerksamkeit und bringt Speisen optimal zur Geltung. Die Speisen werden noch mehr in den Blickpunkt gerückt.

The surfaces of the FUSION series have a mirror shiny inside and a matte outside. The unique design demands the utmost attention. The food moves even more in the focus.

Las superficies de la serie FUSION tienen un interior brillante y un exterior mate. El diseño único exige la máxima atención. Los platos reciben un enfoque aún mayor.

Les surfaces de la série FUSION sont brillantes à l'intérieur et mates à l'extérieur. Le design spéciale exige la plus grande attention. Les plats sont mise encore plus dans le centre de l'attention.



Schale „FUSION“

bowl
cuenco
bol



	Ø cm	↑ cm	ltr.
84022	11	7,0	0,3
84023	17	8,5	1,0
84024	20	8,0	1,2



Tablett „FUSION“

tray
bandeja
plateau



	cm	↑ cm
84025	23,5 x 7,5	2

SINUS



84231

Charakterstark und mit dem Anspruch an Funktionalität und Design präsentiert sich die Buffetserie SINUS. Die großzügigen Flächen für die Speisenpräsentation sind ausdrucksstark eingefasst und gewährleisten ein optimales Handling.

The SINUS buffet series is characterful and with a high standard of functionality and design. The spacious areas for the food presentation are expressively enclosed and ensure optimal handling in everyday dining.

La serie de buffet SINUS demuestra un carácter fuerte y tiene un alto nivel de funcionalidad y diseño. Las áreas espaciales para la presentación de la comida son expresivamente enmarcadas y aseguran un manejo óptimo en la gastronomía.

La série de buffet SINUS est pleine de caractère et avec un haut niveau de fonctionnalité et de design. Les zones spacieuses pour la présentation de la nourriture sont expressivement encadrées et assurent une maniabilité optimale dans la restauration.



GN 1/1

GN 2/4

GN Tablett „SINUS“

GN tray
GN bandeja
GN plateau



	cm	↑ cm	GN	Farbe / Colour
84230	53 x 32,5	2	1/1	White
84231	53 x 16,2	2	2/4	White
	cm	↑ cm	GN	Farbe / Colour
84260	53 x 32,5	2	1/1	Black
84261	53 x 16,2	2	2/4	Black



1,5 ltr.

84232



Schale „SINUS“

bowl
cuenco
bol



	cm	↑ cm	ltr.
84229	10,5 x 10,5	4,0	0,1
84232	21,0 x 21,0	9,0	1,5
84233	25,0 x 25,0	11,0	2,4
84234	28,5 x 28,5	12,5	3,5

HALFTONE



Fingerfood Löffel „HALFTONE“

party spoon
cuchara party
cuillère party



MAX
70°C



	Ø cm	↑ cm	Farbe / Colour	VE / unit
84158	5,5	7	■ ■	24



Fingerfood Löffel „HALFTONE“

party spoon
cuchara party
cuillère party



MAX
70°C



	cm	↑ cm	Farbe / Colour	VE / unit
84128	14,5 x 4,5	4,5	■ ■	12



Tablett „HALFTONE“

tray
bandeja
plateau



MAX
70°C



	cm	↑ cm
84124	20,5 x 12,5	3
84125	24,5 x 15,0	3



Tablett „HALFTONE“

tray
bandeja
plateau



MAX
70°C



	cm	↑ cm
84126	29 x 18	4



Schale „HALFTONE“

bowl
cuenco
bol



	Ø cm	↑ cm	litr.	VE / unit
84217	8	4	0,1	12



84130

84134

Schale „HALFTONE“

bowl
cuenco
bol



	cm	↑ cm	litr.
84130	11,5 x 7,0	4,0	0,05
84131	14,0 x 8,0	4,5	0,10
84132	15,0 x 9,5	5,0	0,15
84133	17,5 x 13,5	6,5	0,35
84134	24,0 x 17,5	7,5	0,8



84136

Schale „HALFTONE“

bowl
cuenco
bol



	Ø cm	↑ cm	litr.
84135	16,5	7,5	0,65
84136	19,0	8,5	1,00

PADELLA



85150

85151



85150

85151

Schale „PADELLA“

bowl
cazuelita
plat 2 anses „cocotte“



	Ø cm	↑ cm	litr.	Griff / handle cm
85150	21	9	1,5	5 x 3,5
85151	28	9	3,0	5 x 3,5



stapelbar und rutschfest
stackable and nonslip



Detailansicht
close up view

TAO



Schale, rund „TAO“

bowl, round
cuenco, redondo
bol, rond



	cm	↑ cm	ltr.	Farbe / Colour
83648	10,5 x 10,0	6,5 / 3,0	0,07	White
83651	13,5 x 12,5	8,5 / 4,0	0,15	White
83654	17,0 x 16,0	10,5 / 4,5	0,3	White
83649	10,5 x 10,0	6,5 / 3,0	0,07	Black
83652	13,5 x 12,5	8,5 / 4,0	0,15	Black
83655	17,0 x 16,0	10,5 / 4,5	0,3	Black



Schale, quadratisch „TAO“

bowl, square
cuenco, cuadrado
bol creux carré



	cm	↑ cm	ltr.	Farbe / Colour
83642	30,5 x 30,5	10	3,3	White
83643	30,5 x 30,5	10	3,3	Black



Schale, rechteckig „TAO“

bowl, rectangular
cuenco, rectangular
bol creux rectangulaire



	cm	↑ cm	ltr.	Farbe / Colour
83639	32,5 x 17,5	10	1,8	White
83640	32,5 x 17,5	10	1,8	Black

APART



GN Tablett „APART“

GN tray
GN bandeja
GN plateau



	cm	↑ cm	GN
83828	53,0 x 32,5	2,5	1/1
83830	32,5 x 26,5	2,5	1/2
83832	32,5 x 17,6	2,5	1/3



Tablett „APART“

tray
bandeja
plateau



	cm	↑ cm
83834	23,0 x 23,0	2,5
83836	33,0 x 33,0	2,5



Schale „APART“

bowl
cuenco
bol



	∅ cm	↑ cm	ltr.
83800	6,5	3,0	0,045



Schale „APART“

bowl
cuenco
bol



	cm	↑ cm	ltr.
83808	6,6 x 6,6	3,0	0,05
83810	10 x 10	4,5	0,17
83812	15 x 15	6,5	0,5
83814	20 x 20	9,0	1,6



GN 2/4 Schale „APART“

GN 2/4 bowl
GN 2/4 cuenco
GN 2/4 bol



	cm	↑ cm	ltr.	GN
83826	53,0 x 16,2	6,5	3	2/4

GLOBAL BUFFET

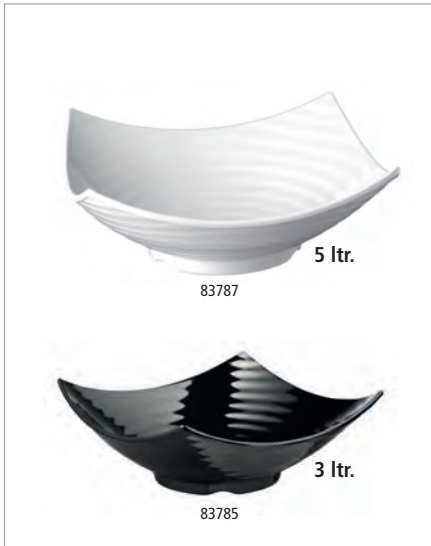

Schale „GLOBAL BUFFET“

bowl
cuenco
bol



	cm	↑ cm	ltr.	Farbe / Colour
83785	32,5 x 32,5	12,0	3,0	White
83786	35,0 x 35,0	12,5	3,5	White
83787	40,0 x 40,0	13,5	5,0	White
84785	32,5 x 32,5	12,0	3,0	Black
84786	35,0 x 35,0	12,5	3,5	Black
84787	40,0 x 40,0	13,5	5,0	Black



Schale „GLOBAL BUFFET“

bowl
cuenco
bol



	cm	↑ cm	ltr.	Farbe / Colour
84464	35,5 x 31,5	14,0	2,5	White
84466	46,0 x 40,0	18,5	5,5	White



Schale „GLOBAL BUFFET“

bowl
cuenco
bol



	cm	↑ cm	ltr.	Farbe / Colour
83799	25,5 x 25,5	13,0	3,0	White
83788	32,0 x 32,0	16,5	4,5	White
83789	35,0 x 35,0	17,0	6,0	White
83790	40,0 x 40,0	17,5	8,0	White



Schale „GLOBAL BUFFET“

bowl
cuenco
bol



die Melaminschale wirkt optisch wie der Naturstein Granit
the melamine bowl looks visually as made of natural granit stone
el cuenco de melamina parece estar hecho de granito natural
le bol de mélamine donne une impression visuelle de granit naturel

	cm	↑ cm	ltr.	Farbe / Colour
84387	36 x 36	11	3,5	Black

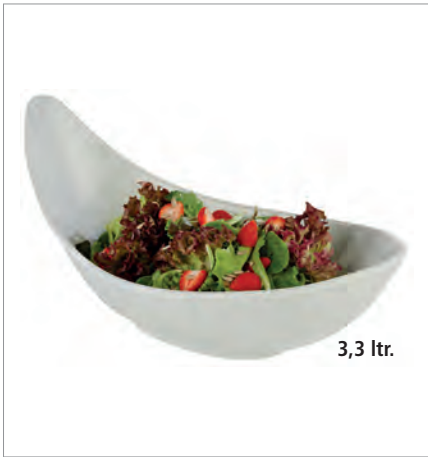

3,3 ltr.

Schale „GLOBAL BUFFET“

bowl
cuenco
bol



	cm	↑ cm	ltr.	Farbe / Colour
84462	44 x 25	20	3,3	_____



84200

1,0 ltr.

Schale „LEAF“

bowl
cuenco
bol



	cm	↑ cm	ltr.	Farbe / Colour
84200	42 x 19,5	6,5	1,0	_____
84202	50 x 23,0	7,5	1,5	_____



1,0 ltr.

Schale „BIG WAVE“

bowl
cuenco
bol



	cm	↑ cm	ltr.	Farbe / Colour
83587	33 x 24	8,5	1	_____



Etagère

etagère
expositor
présentoir



inklusive Edelstahl-Schild, beschriftbar

including stainless steel sign, inscribable

placa de acero inoxidable incluida, rotulable

étiquette en acier inox incluse, inscriptible

	Ø cm	↑ cm	
34248	31 - 41 - 51	55	3-stufig / 3-tier 3 niveles / 3 étages

FLYING BUFFET



Fingerfood-Teller „FLYING BUFFET“

fingerfood plate
plato para el aperitivo
assiette pour apéritif



	cm	↑ cm	Farbe / Colour
83878	9,5 x 9,5	1,5 / 3,5	White
83879	9,5 x 9,5	1,5 / 3,5	Black



Schale „FLOAT“

bowl
cuenco
bol



	cm	↑ cm	Farbe / Colour
83912	9 x 9	4,5	White
83913	9 x 9	4,5	Black



GN Tablett

GN tray
GN bandeja
GN plateau



	cm	↑ cm	GN
83828	53 x 32,5	2,5	1/1



GN Edelstahl Tablett

GN stainless steel platter
GN bandeja de acero inoxidable
GN plateau en acier inox



	cm	GN
11119	53 x 32,5	1/1

CASCADE

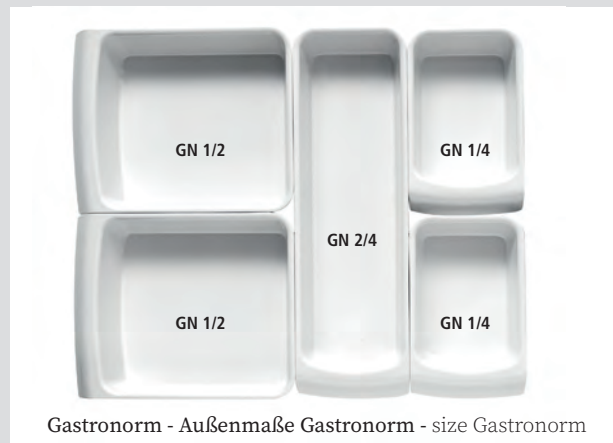

83960

Schale „CASCADE“

bowl
cuenco
bol



	cm	↑ cm	GN	ltr.
83960	32,5 x 26,5	7,5	1/2	3,65
83962	26,5 x 16,2	7,5	1/4	1,50



83965

83967

Tablett „CASCADE“

tray
bandeja
plateau



	cm	↑ cm	GN	fits to
83965	32,5 x 26,5	2,4	1/2	83960
83967	26,5 x 16,2	2,4	1/4	83962



Tablett kann als Deckel eingesetzt werden!

Tray is also useable as a cover!

¡La bandeja se puede usar como tapa!

Le plat s'utilise aussi comme couvercle!



83961

83966

Schale „CASCADE“

bowl
cuenco
bol



	cm	↑ cm	GN	ltr.
83961	53 x 16,2	7,5	2/4	3,65

Tablett „CASCADE“

tray
bandeja
plateau

	cm	↑ cm	GN	fits to
83966	53 x 16,2	2,4	2/4	83961



FLOAT



- Ideal für den Thekenbereich
- stapelbar mit Löffel und Deckel
- Schalenboden fixiert sich auf dem Deckel
- rutschfest (Antirutschfüßchen)

- ideal for the counter area
- stackable with spoon and lid
- the bottom of the bowl is fixed on the lid
- non-slip (with non-slip feet)

- ideal para la zona del mostrador
- apilable con cuchara y tapa
- el fondo del cuenco se fija en la tapa
- antideslizante (con pies antideslizantes)

- idéal pour l'aire de comptoir
- empilable avec cuillère et couvercle
- le fond du bol se fixe sur le couvercle
- antidérapant (avec pieds antidérapants)



Schale „FLOAT“

bowl
cuenco
bol



	Ø cm	↑ cm	ltr.	Farbe / Colour
83900	5,5	3,0	0,03	White
83902	9,0	4,5	0,15	White
83904	13,0	6,5	0,45	White
83906	15,0	7,5	0,70	White
83908	20,5	10,0	1,90	White
83901	5,5	3,0	0,03	Black
83903	9,0	4,5	0,15	Black
83905	13,0	6,5	0,45	Black
83907	15,0	7,5	0,70	Black
83909	20,5	10,0	1,90	Black



Schale „FLOAT“

bowl
cuenco
bol



	cm	↑ cm	ltr.	Farbe / Colour
83910	5,5 x 5,5	3,0	0,03	White
83912	9,0 x 9,0	4,5	0,16	White
83914	12,5 x 12,5	6,0	0,50	White
83916	19,0 x 19,0	9,5	1,90	White
83918	25,0 x 25,0	12,0	4,70	White
83911	5,5 x 5,5	3,0	0,03	Black
83913	9,0 x 9,0	4,5	0,16	Black
83915	12,5 x 12,5	6,0	0,50	Black
83917	19,0 x 19,0	9,5	1,90	Black
83919	25,0 x 25,0	12,0	4,70	Black



stapelbar
stackable



GN Tablett „FLOAT“

GN tray
GN bandeja
GN plateau



	cm	↑ cm	GN	Farbe / Colour
83923	53,0 x 32,5	3	1/1	White
83925	32,5 x 26,5	3	1/2	White
83924	53,0 x 32,5	3	1/1	Black
83926	32,5 x 26,5	3	1/2	Black



Deckel „FLOAT“ mit Löffelaussparung

cover, with notched for spoons
tapa, con espacio para la cuchara
couvre-cle, avec encoche pour la louche



	cm	↑ cm	fits to
83920	Ø 20,5	1,3	83908, 83909
83921	19 x 19	1,3	83916, 83917
83922	25 x 25	1,3	83918, 83919

PURE



83401

83479

84441

Tablett „PURE“ tray bandeja plateau



	cm	↑ cm	GN	Farbe / Colour
83401	53,0 x 32,5	3	1/1	White
83588	35,4 x 32,5	3	2/3	White
83433	53,0 x 16,2	3	2/4	White
83480	32,5 x 26,5	3	1/2	White
83481	32,5 x 17,6	3	1/3	White
83482	26,5 x 16,2	3	1/4	White
83882	65,0 x 26,5	3		White
83597	40,0 x 30,0	3	Bäcker-Maß	White

	cm	↑ cm	GN	Farbe / Colour
83479	53,0 x 32,5	3	1/1	Black
83589	35,4 x 32,5	3	2/3	Black
83434	53,0 x 16,2	3	2/4	Black
83490	32,5 x 26,5	3	1/2	Black
83491	32,5 x 17,6	3	1/3	Black
83492	26,5 x 16,2	3	1/4	Black
83592	40,0 x 30,0	3	Bäcker-Maß	Black

	cm	↑ cm	GN	Farbe / Colour
84440	53,0 x 32,5	3	1/1	Granite
84441	32,5 x 26,5	3	1/2	Granite

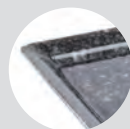

Granitoptik
granite look



Tablett „PURE“

tray
bandeja
plateau



	cm	↑ cm	Farbe / Colour
83625	31,0 x 10,5	2	
83403	35,5 x 18,0	3	
83417	30,0 x 21,0	3	
83402	53,0 x 18,0	3	

	cm	↑ cm	Farbe / Colour
83483	53 x 18	3	

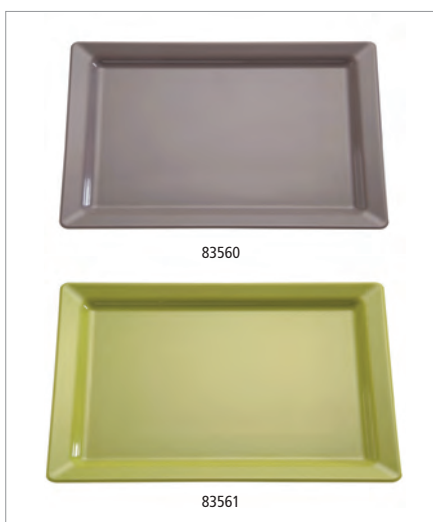

Tablett „PURE COLOR“

tray
bandeja
plateau

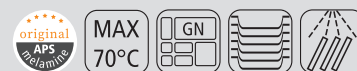

	cm	↑ cm	GN	Farbe / Colour
83560	53,0 x 32,5	3	1/1	
83562	32,5 x 26,5	3	1/2	
83561	53,0 x 32,5	3	1/1	
83563	32,5 x 26,5	3	1/2	



Tablett quadratisch „PURE“

tray square
bandeja cuadrada
plateau carré



	cm	↑ cm	Farbe / Colour
83418	18,0 x 18,0	3	
83407	21,0 x 21,0	3	
83406	26,5 x 26,5	3	
83405	37,0 x 37,0	3	
83404	51,0 x 51,0	3	

	cm	↑ cm	Farbe / Colour
83400	51 x 51	3	



Tablett / Teller „PURE“

tray / plate
bandeja / plato
plateau / assiette



	Ø cm	↑ cm	Farbe / Colour
83884	31	2,5	
83869	38	2,5	
83886	41	2,5	
83484	51	2,5	



Schale „PURE“

bowl
cuenco
bol



	Ø cm	↑ cm	ltr.	Farbe / Colour
83450	5,5	4,0	0,02	White
83419	9,0	4,5	0,09	White
83453	13,0	6,5	0,30	White
83455	15,0	7,5	0,45	White
83415	20,0	10,5	1,25	White
	Ø cm	↑ cm	ltr.	Farbe / Colour
83451	5,5	4,0	0,02	Black
83452	9,0	4,5	0,09	Black
83454	13,0	6,5	0,30	Black
83456	15,0	7,5	0,45	Black
83457	20,0	10,5	1,25	Black



Teller, rund „CASUAL“

plate, round
plato, redondo
assiette, ronde



	Ø cm	↑ cm
83500	22,5	2,5
83514	26,5	2,5



Schale „PURE COLOR“

bowl
cuenco
bol



	cm	↑ cm	ltr.	Farbe / Colour
84424	6,5 x 6,5	3,0	0,05	White
83414	9,0 x 9,0	4,0	0,14	White
83410	12,5 x 12,5	6,5	0,40	White
83409	19,0 x 19,0	9,0	1,50	White
83408	25,0 x 25,0	12,0	3,80	White
84425	32,0 x 32,0	14,0	8,0	White
	cm	↑ cm	ltr.	Farbe / Colour
84426	6,5 x 6,5	3,0	0,05	Black
83466	9,0 x 9,0	4,0	0,14	Black
83467	12,5 x 12,5	6,5	0,40	Black
83468	19,0 x 19,0	9,0	1,50	Black
83469	25,0 x 25,0	12,0	3,80	Black
84427	32,0 x 32,0	14,0	8,0	Black
	cm	↑ cm	ltr.	Farbe / Colour
83568	9,0 x 9,0	4,0	0,14	Brown
83570	12,5 x 12,5	6,5	0,40	Brown
83572	19,0 x 19,0	9,0	1,50	Brown
83574	25,0 x 25,0	12,0	3,80	Brown
	cm	↑ cm	ltr.	Farbe / Colour
83569	9,0 x 9,0	4,0	0,14	Olive Green
83571	12,5 x 12,5	6,5	0,40	Olive Green
83573	19,0 x 19,0	9,0	1,50	Olive Green
83575	25,0 x 25,0	12,0	3,80	Olive Green

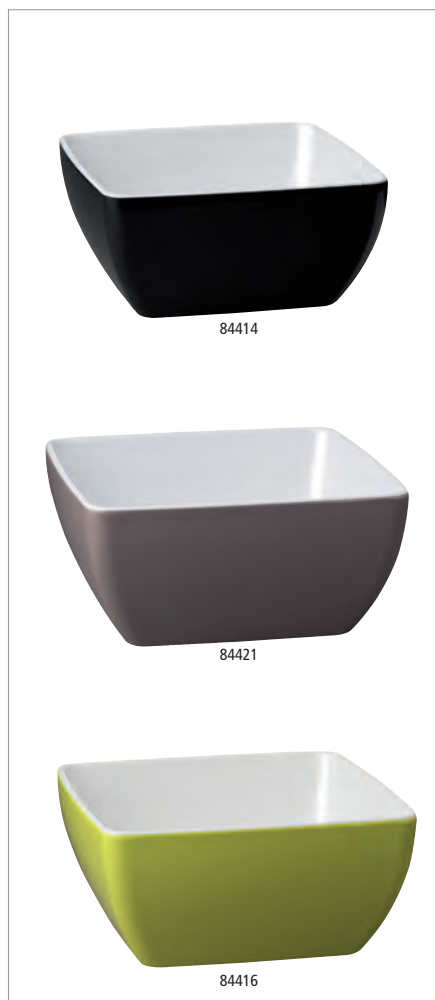

Schale „PURE BICOLOR“

bowl
cuenco
bol



	cm	↑ cm	ltr.	Farbe / Colour
84414	9,0 x 9,0	4,0	0,14	■ ■
84409	19,0 x 19,0	9,0	1,50	■ ■
84408	25,0 x 25,0	12,0	3,80	■ ■

	cm	↑ cm	ltr.	Farbe / Colour
84420	9,0 x 9,0	4,0	0,14	■ ■
84421	12,5 x 12,5	6,5	0,40	■ ■
84422	19,0 x 19,0	9,0	1,50	■ ■
84423	25,0 x 25,0	12,0	3,80	■ ■

	cm	↑ cm	ltr.	Farbe / Colour
84415	9,0 x 9,0	4,0	0,14	■ ■
84416	12,5 x 12,5	6,5	0,40	■ ■
84417	19,0 x 19,0	9,0	1,50	■ ■
84418	25,0 x 25,0	12,0	3,80	■ ■



Schale „SLATE“

bowl
cuenco
bol



	cm	↑ cm	ltr.
84244	19 x 19	9	1,5
84245	25 x 25	12	3,8

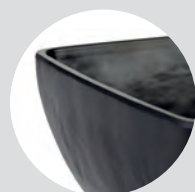

1:1 Oberflächenansicht
1:1 structural view



Deckel „PURE“ mit Löffelaussparung

cover with notched for spoons
tapa con espacio para la cuchara
couverture avec encoche pour la louche



	cm	↑ cm	fits to
83600	19 x 19	1,5	84409, 84417, 84422, 83409, 83468, 83572, 83573
83601	25 x 25	1,5	84408, 84418, 84423, 84430, 83575, 83574, 83469, 83408
83602	32 x 32	1,5	84425, 84427



83603

passend zu Schalen 12,5 x 12,5 cm
fits to bowls 12,5 x 12,5 cm



83604

passend zu Schalen 19 x 19 cm
fits to bowls 19 x 19 cm



83410



83468

Deckel „PURE“, 5er Set

cover, 5 pcs.
tapa, set de 5
couvercle, set de 5



Hygienischer Schutz für Ihre Speisen

- dichtschießend
- schwappsicherer Transport
- BPA-frei

protection for your food

- tightly closing
- slosh-proof transport
- bpa-free

protección de alimentos

- con cierre hermético
- transporte sin salpicaduras
- libre de BPA

protection des aliments

- fermeture hermétique
- transport sans éclaboussures
- sans BPA

	cm	↑ cm	VE	fits to
83603	13,0 x 13,0	0,5	5	83410, 83467, 83570, 83571, 84410, 84416, 84421
83604	19,5 x 19,5	0,5	5	83409, 83468, 83572, 83573, 84244, 84409, 84417, 84422, 84830



83497



83498

Schale „PURE“

bowl
cuenco
bol



	cm	↑ cm	litr.
83497	22,5 x 15,5	7,5	0,80
83498	38,5 x 15,5	7,5	1,50
83499	51,0 x 15,5	7,5	2,40



Menage „PURE“

menage
conjunto aperitivo
set apéritif



4-teilig: 1 Ständer, Edelstahl matt poliert + 3 Melamin-Schalen, weiß (Nr. 83419)

4 pcs. set: 1 stainless stand satin polished finish + 3 white bowls (No. 83419)

set de 4: 1 soporte, acero inoxidable pulido mate + 3 cuencos de melamina blancos (ref. 83419)

set de 4: 1 support, acier inox poli mat + 3 bols de mélamine blancs (ref. 83419)

	cm	↑ cm
09924	14 x 14	16



Menage „PURE“

menage
conjunto aperitivo
set apéritif



5-teilig: 1 Ständer, Edelstahl matt poliert + 4 Melamin-Schalen, weiß (Nr. 83414)

5 pcs. set: 1 stainless stand satin polished finish + 4 square white bowls (No. 83414)

set de 5: 1 soporte, acero inoxidable pulido mate + 4 cuencos de melamina blancos (ref. 83414)

set de 5: 1 support, acier inox poli mat + 4 bols de mélamine blancs (ref. 83414)

	cm	↑ cm
09923	17 x 17	16



Schale / Pastateller „PURE“

bowl / pasta plate
cuenco / plato para pasta
bol / assiette creuse



	Ø cm	↑ cm	ltr.	Farbe / Colour
83412	32,0	7,5	1,5	White
83411	45,5	9,0	1,7	White



Tablett „MADE FOR PURE“

tray
bandeja
plateau



Edelstahl matt poliert, passend für Melamin-Schalen
stainless steel satin polished finish, for melamin bowls
acero inoxidable pulido mate, apta para cuencos de melamina
acier inox poli mat, pour bols de mélamine

	cm	
30120	20 x 11	für 2 Schalen / for 2 bowls para 2 cuencos / pour 2 bols
30121	29 x 20	für 6 Schalen / for 6 bowls para 6 cuencos / pour 6 bols

Schale „PURE COLOR“ / bowl / cuenco / bol

	cm	↑ cm	ltr.	Farbe / Colour
83414	9 x 9	4	0,14	White
83466	9 x 9	4	0,14	Black
83568	9 x 9	4	0,14	Grey
83569	9 x 9	4	0,14	Green

Schale „PURE BICOLOR“ / bowl / cuenco / bol

	cm	↑ cm	ltr.	Farbe / Colour
84414	9 x 9	4	0,14	Black/White
84415	9 x 9	4	0,14	Green/White
84420	9 x 9	4	0,14	Grey/White



GN Tablett

GN tray
GN bandeja
GN plateau



	cm	↑ cm	GN
84046	53,0 x 32,5	2	1/1
84047	32,5 x 26,5	2	1/2
84048	32,5 x 17,6	2	1/3

NATURAL COLLECTION



Blattschale „NATURAL COLLECTION“

leaf
fuente en forma de hoja
plateau feuille



	cm	↑ cm	Farbe / Colour
84083	40 x 18,5	3,5	
84086	52 x 25,0	4,0	
	cm	↑ cm	Farbe / Colour
84085	40 x 18,5	3,5	
84088	52 x 25,0	4,0	



Palmblattschale „NATURAL COLLECTION“

palm leaf
fuente en forma de hoja de palmera
plateau feuille de palme



	cm	↑ cm	litr.	Farbe / Colour
84080	40 x 18,5	10	1,8	
84082	40 x 18,5	10	1,8	



stapelbar, mit Löffelablage
stackable, for spoons
apilable, práctico para cubiertos de servicio
empilable, pratique pour déposer les couverts



Blattschale „NATURAL COLLECTION“

leaf
fuente en forma de hoja
plateau feuille



	cm	↑ cm	Farbe / Colour
83864	34,5 x 8	2,5	
83862	34,5 x 8	2,5	



Blattschale „NATURAL COLLECTION“

leaf
fuente en forma de hoja
plateau feuille



	cm	↑ cm	Farbe / Colour
83435	36 x 16	3,0	
83438	45 x 24	3,0	
83441	53 x 29	3,5	
	cm	↑ cm	Farbe / Colour
83437	36 x 16	3,0	
83440	45 x 24	3,0	
83443	53 x 29	3,5	



Palmblattschale „NATURAL COLLECTION“

palm leaf
fuente en forma de hoja de palmera
plateau feuille de palme



	cm	↑ cm	Farbe / Colour
83865	27 x 27	4,5	
83446	35 x 34	4,5	



Schale „FLOWER POT“

bowl
cuenco
bol



	Ø cm	↑ cm	ltr.	Farbe / Colour
84470	6	3,5	0,04	
84471	6	3,5	0,04	
84472	6	3,5	0,04	

	Ø cm	↑ cm	ltr.	Farbe / Colour
84473	9	8,5	0,30	
84474	9	8,5	0,30	
84475	9	8,5	0,30	

	Ø cm	↑ cm	ltr.	Farbe / Colour
84476	12	3,5	0,20	
84478	12	3,5	0,20	

	Ø cm	↑ cm	ltr.	Farbe / Colour
84479	13	15	1,00	
84481	13	15	1,00	



Schale „POKE BOWL“

bowl
cuenco
bol



	Ø cm	↑ cm	ltr.	Farbe / Colour
85003	20	7	0,9	white
85005	20	7	0,9	coconut



Schale, oval „CLASSIC WAVE“

bowl, oval
cuenco, ovalada
plateau ovale



	cm	↑ cm	ltr.	Farbe / Colour
83875	27 x 17	4,0	0,80	
83876	34 x 21	4,5	1,30	
83877	47 x 29	5,0	3,20	



ENAMEL LOOK



Suppenteller „ENAMEL LOOK“
soup plate
plato hondo
assiette creuse



MAX 70°C



	Ø cm	↑ cm
84952	19,0	3
84953	22,5	4
84954	24,5	4

Farbe / Colour



Schale „ENAMEL LOOK“
bowl
cuenco
bol



MAX 70°C



	Ø cm	↑ cm	ltr.
84490	5,5	4,0	0,02
84491	9,5	4,5	0,09
84492	13,0	6,5	0,30
84493	15,0	7,5	0,45
84494	20,0	10,5	1,25

Farbe / Colour





Schale „ENAMEL LOOK“

bowl
cuenco
bol



	cm	↑ cm	ltr.	Farbe / Colour
84955	15,5 x 11,5	3,5	0,25	
84956	17,5 x 13,0	4,5	0,30	



Teller „ENAMEL LOOK“

plate
plato
assiette



	Ø cm	↑ cm	Farbe / Colour
84950	20,5	2,0	
84951	24,5	2,5	

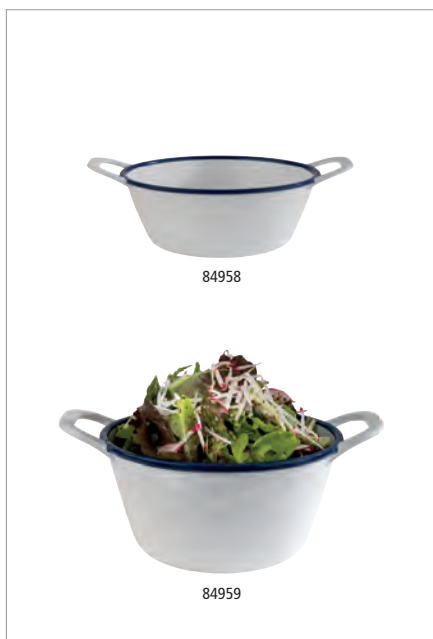

Schale „ENAMEL LOOK“

bowl
cuenco
bol



	cm	↑ cm	ltr.	Farbe / Colour
84958	15,0 x 11,5	6,5	0,30	
84959	21,5 x 16,5	9,5	1,00	



Schale „ENAMEL LOOK“

bowl
cuenco
bol



	cm	↑ cm	ltr.	Farbe / Colour
84957	29,0 x 23,5	5	1,5	

CASUAL



Schälchen „CASUAL MINI“

bowl
cuenco
bol mini



MAX
70°C



	cm	↑ cm	ltr.	Farbe / Colour
83880	6,0	2,5	0,02	White
83881	7,5	3,5	0,05	White



Schale „CASUAL MAXI“

bowl
cuenco
bol



MAX
70°C



	Ø cm	↑ cm	ltr.	Farbe / Colour
83696	10	4,5	0,15	White
83698	12	5,5	0,25	White
83700	14	6,5	0,50	White
83704	20	9,2	1,80	White
83702	23	10,5	2,50	White
.....				
	Ø cm	↑ cm	ltr.	Farbe / Colour
83697	10	4,5	0,15	Black
83699	12	5,5	0,25	Black
83701	14	6,5	0,50	Black
83705	20	9,2	1,80	Black
83703	23	10,5	2,50	Black

Deckel „FLOAT“ mit Löffelaussparung / cover, with notched for spoons / tapa, con espacio para la cuchara / couvercle, avec encoche pour la louche

	Ø cm	↑ cm	fits to
83920	20,5	1,3	83704, 83705



Dipschälchen „CASUAL“

dip bowl
cuenco para dip
ramequin



MAX
70°C



	Ø cm	↑ cm	ltr.	Farbe / Colour	VE / unit
83780	6,0	3,7	0,04	White	24
83781	7,0	3,7	0,05	White	24
83782	7,8	4,0	0,08	White	24
83783	8,5	4,5	0,11	White	24
83784	9,8	4,5	0,14	White	12
83798	6,0	3,7	0,04	Black	24
83777	6,0	3,5	0,03	Terracotta	24



Set „CASUAL“, 4-teilig

set, 4 pcs.
set de 4
set de 4



4-teiliges Set:

- 2 Schalen + 2 Deckel
- dichtschießend

4 pcs.:

- 2 bowls + 2 covers
- tightly closing

set de 4:

- 2 cuencos + 2 tapas
- con cierre hermético

set de 4:

- 2 bols + 2 couvercles
- fermeture hermétique

	Ø cm	↑ cm	ltr.	Farbe / Colour
85160	14	6,5	0,5	■
85161	14	6,5	0,5	■
85162	20	9	1,8	■
85163	20	9	1,8	■

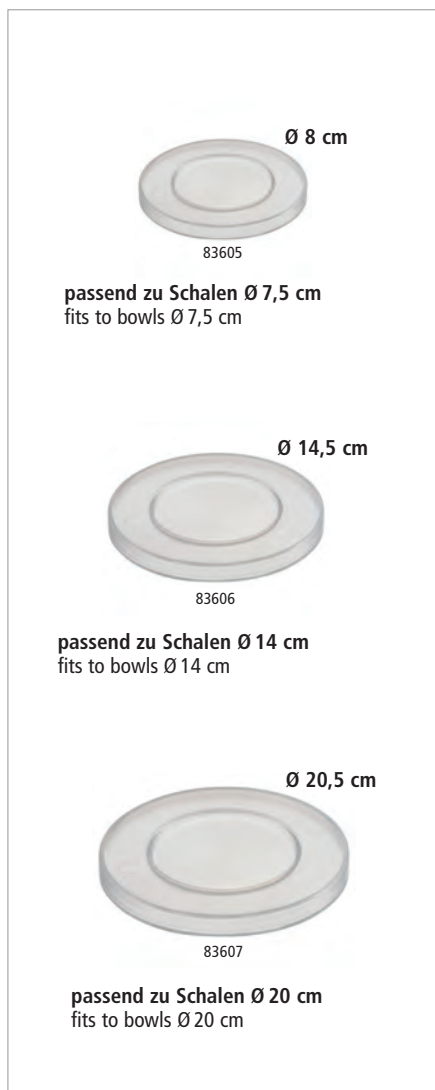

Deckel „CASUAL“, 5er Set

cover, 5 pcs.
tapa, set de 5
couvercle, set de 5



Hygienischer Schutz für Ihre Speisen

- dichtschießend
- schwappsicherer Transport
- BPA-frei

protection for your food

- tightly closing
- slosh-proof transport
- bpa-free

protección de alimentos

- con cierre hermético
- transporte sin salpicaduras
- libre de BPA

protection des aliments

- fermeture hermétique
- transport sans éclaboussures
- sans BPA

	Ø cm	↑ cm	VE	fits to
83605	8,0	0,5	5	11866, 83881, 15400, 15408, 15416, 15461, 15462, 15467, 15468, 40655, 40656
83606	14,5	0,5	5	11865, 83700, 83701, 84990, 85104, 85105, 85107
83607	20,5	0,5	5	83704, 83705, 15105, 15230, 15404, 15412, 15420, 85003, 85005

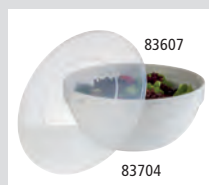

stapelbar / stackable

CASUAL · SCANTIC · ORGANIC



Schale „CASUAL“

bowl
cuenco
bol



	Ø cm	↑ cm	ltr.
84215	10	6,5 / 8,5	0,2
84216	12	7,5 / 9,5	0,3



Schale „CASUAL“

bowl
cuenco
bol



	Ø cm	↑ cm	ltr.	Farbe / Colour
84295	10	7	0,13	White



Dipschale „CASUAL“

dip tray
bandeja para dips
plateau pour dips



	cm	↑ cm
84220	29 x 9	3



Schale „SCANTIC“

bowl
cuenco
bol



	cm	↑ cm	ltr.
84221	26,5 x 10,5	6,5	1,0
84222	53,0 x 10,5	6,5	2,0



Schale „ORGANIC“

bowl
cuenco
bol



	cm	↑ cm	ltr.	Farbe / Colour
84235	32,5 x 17	5,5	1,0	White
84236	50,0 x 26	6,5	3,5	White

NEW

BRÖTCHENSCHÜTTE



85140



85141

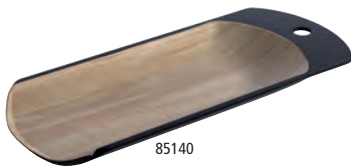

85140



85140

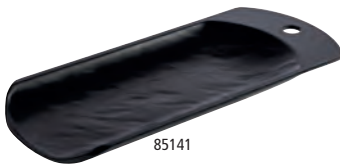

85141



85141

Tablett „BRÖTCHENSCHÜTTE“

tray
bandeja
plateau

	cm	↑ cm	Farbe / Colour
85140	41 x 18	2,3	
85141	41 x 18	2,3	



85140

Griffbereich mit Aufhängeloch
handle area with hanging hole

85141

Holzoptik
wood lookSchieferoptik
slate look



Servier- und Tortenplatte „CLASSIC“

cake stand
porta pasteles
présentoir à gâteaux



Rand fixiert die Haube
carved edge fixes the cover
ranura para fijar bien la campana
bord rainuré pour maintenir ferme la cloche

	Ø cm	↑ cm
85051	30,5	9
85052	30,5	17



Servier- und Tortenplatte „CASUAL“

cake plate
porta pasteles
présentoir à gâteaux



	Ø cm	↑ cm
83890	31	8
83891	31	16



Servier- und Tortenplatte „CASUAL“

cake plate
porta pasteles
présentoir à gâteaux



	cm	↑ cm
83892	31 x 31	8
83893	31 x 31	16



Torten- / Konditorplatte

cake stand
soporte para pastel
présentoir à gâteaux



Rand fixiert die Haube, mit Antirutsch-Füßchen
carved edge fixes the cover, with non-slip feet
ranura para fijar bien la campana, con pies antideslizantes
bord rainuré pour maintenir ferme la cloche, avec pieds antidérapants

	Ø cm	↑ cm	Farbe / Colour
00468	31,0	3,5	White
00469	31,0	3,5	Black



Schale „BALANCE“

bowl
cuenco
bol



	Ø cm	↑ cm	ltr.	Farbe / Colour
84040	14,5	9,0	0,4	■
84041	21,0	13,0	1,5	■
84042	24,5	15,0	2,5	■
84043	30,0	19,5	5,0	■

	Ø cm	↑ cm	ltr.	Farbe / Colour
85040	14,5	9,0	0,4	■
85041	21,0	13,0	1,5	■
85042	24,5	15,0	2,5	■
85043	30,0	19,5	5,0	■

Buffetständer „KING“ / buffet stand / soporte para buffet / présentoir buffet

	Ø cm	↑ cm
03622	15	14
03623	15	21



Tablett / Teller

tray / plate
bandeja / plato
plateau / assiette



	Ø cm	↑ cm	Farbe / Colour
83869	38	2,5	■

Rolltophaube / rolltop cover / campana abatible / cloche basculante

	Ø cm	↑ cm	
18388	38	20	mit verchromtem Kugelgriff / with chrome plated handle con pomo cromado / avec bouton chromé



Frischhalte-Haube

cover
campana
cloche



	Ø cm	↑ cm	
06510	30	11,5	
06512	30	11,5	mit verchromtem Griff / with chrom plated handle con botón cromado / avec bouton chromé

NEW

SERVING-BOX „L“



7 tlg.
7 pcs.



FOR
INDOOR &
OUTDOOR USE
ROOM-, POOL-
& BEACH-
SERVICE, ...



85091



85088



85091



85091



85088

Serving-Box „L“

serving box
caja comida
boîte-repas



MAX
70°C

SILIKON
SILICON



7 teiliges Set:

- 1 Box + 1 Deckel
- 1 Schale groß (23 x 14 x 6 cm, 1,4 ltr.)
- 1 Schale mittel (14 x 11,5 x 6 cm, 0,6 ltr.)
- 2 Schalen klein (11,5 x 7 x 6 cm, 0,25 ltr.)
- 1 Antirutsch-Matte (26 x 21 cm)

7 pcs.:

- 1 box + 1 cover
- 1 bowl large (23 x 14 x 6 cm, 1,4 ltr.)
- 1 bowl medium (14 x 11,5 x 6 cm, 0,6 ltr.)
- 2 bowls small (11,5 x 7 x 6 cm, 0,25 ltr.)
- 1 non-slip mat (26 x 21 cm)

set de 7:

- 1 caja + 1 tapa
- 1 cuenco, grande (23 x 14 x 6 cm, 1,4 ltr.)
- 1 cuenco mediano (14 x 11,5 x 6 cm, 0,6 ltr.)
- 2 cuencos pequeños (11,5 x 7 x 6 cm, 0,25 ltr.)
- 1 esterilla antideslizante (26 x 21 cm)

set de 7:

- 1 boîte + 1 couvercle
- 1 bol, grand (23 x 14 x 6 cm, 1,4 ltr.)
- 1 bol moyen (14 x 11,5 x 6 cm, 0,6 ltr.)
- 2 bols petits (11,5 x 7 x 6 cm, 0,25 ltr.)
- 1 tapis antidérapant (26 x 21 cm)

	cm	↑ cm	Farbe / Colour
85091	30 x 25	8	
85088	30 x 25	8	



Präsentationsmöglichkeit
presentation example



stapelbar
stackable



85091

Anwendungsbeispiel
application example



Schalen
bowls
cuencos
bols



	cm	↑ cm	ltr.	Farbe / Colour
85191	10,0 x 6,5	3,5	0,10	White
85193	10,0 x 10,0	3,5	0,15	White
85195	20,0 x 10,0	3,5	0,40	White
85192	10,0 x 6,5	3,5	0,10	Black
85194	10,0 x 10,0	3,5	0,15	Black
85196	20,0 x 10,0	3,5	0,40	Black

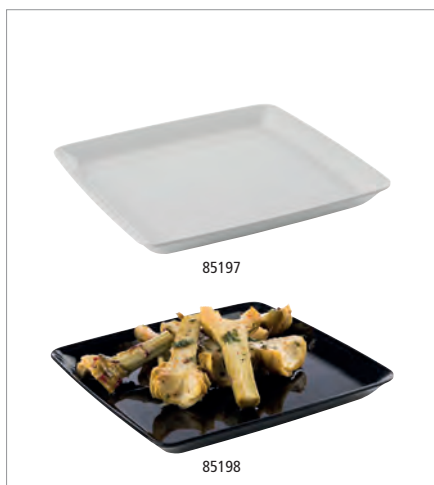

Teller
plates
platos
assiettes



	cm	↑ cm	ltr.	Farbe / Colour
85197	21,5 x 21,5	2	-	White
85198	21,5 x 21,5	2	-	Black



Servierlöffel „PROFI“
serving spoon
cuchara para servir
cuillère de service



	cm	→ cm	Farbe / Colour
84020	7 x 6,5	26,5	White
84021	7 x 6,5	26,5	Black



Salat-Löffel
salad spoon
cuchara para ensalada
cuillère à salade



	cm	↑ cm
84035	24 x 7	4,5



Besteckablage „SPOON“

cutlery rest
reposa cuchara
pose-cuillère



	cm	↑ cm
83801	26 x 10,5	5



Besteckablage „BOWL“

cutlery rest
reposa cuchara
pose-cuillère



	cm	↑ cm	ltr.
83803	22,5 x 11	6	0,5



Besteckablage „SMALL WAVE“

cutlery rest
reposa cuchara
pose-cuillère



	cm	↑ cm
83897	26 x 13	4,5



Teller mit Glashalter „COCKTAIL“

plate with glass holder
plato sujeta copas
assiette porte-verre



eignet sich besonders für Stehempfänge, einhändig nutzbar
particularly suitable for standing receptions, single-handed use
para uso en recepciones de pie, facil de usar con sólo una mano
particulièrement pour des receptions debout, utilisable avec une seule main

	cm	↑ cm
84620	22 x 14	1,5

	Ø cm	↑ cm
84621	19	1,5



Kaffebecher „CASUAL“

coffee cup
taza de café
tasse à café



	Ø cm	↑ cm	ltr.
83513	9,5	10	0,4



Eierbecher, 4er Set

egg holder, 4 pcs. set
huevera, set de 4
coquetier, set de 4



	Ø cm	↑ cm	pcs.
83851	8	3	4
83848	8,5	2	4

FINGERFOOD LÖFFEL



Fingerfood Löffel „HALFTONE“

party spoon
cuchara party
cuillère party



	Ø cm	↑ cm	VE / unit
84158	5,5	7	24



Fingerfood Löffel „HALFTONE“

party spoon
cuchara party
cuillère party



	cm	↑ cm	VE / unit
84128	14,5 x 4,5	4,5	12



Fingerfood Löffel „BOAT“

party spoon
cuchara party
cuillère party



	cm	↑ cm	Farbe / Colour	VE / unit
84140	14,5 x 4,5	4,5		32
84141	14,5 x 4,5	4,5		32
84142	14,5 x 4,5	4,5		12

FINGERFOOD LÖFFEL



Fingerfood Löffel „HONG KONG“

party spoon
cuchara party
cuillère party



	cm	↑ cm	Farbe / Colour	VE / unit
83486	13 x 4,5	4,5		60
83487	13 x 4,5	4,5		60
83424	13 x 4,5	4,5		60
83426	13 x 4,5	4,5		60



Fingerfood-Löffel „MING HING“

party spoon
cuchara party
cuillère party



	cm	↑ cm	Farbe / Colour	VE / unit
83842	11 x 4,5	4		60
83843	11 x 4,5	4		60



Fingerfood-Löffel „LEAF“

party spoon
cuchara party
cuillère party



	cm	↑ cm	Farbe / Colour	VE / unit
83889	10 x 4,5	1,5		50
83887	10 x 4,5	1,5		50
83888	10 x 4,5	1,5		50



MINI



84625



84626



84627

Schale „MINI COLOUR“

bowl
cuenco
bol



	cm	↑ cm	ltr.	Farbe / Colour	VE / unit
84625	12,5 x 9,0	3,5	0,02		12
84626	12,5 x 9,0	3,5	0,02		12
84627	12,5 x 9,0	3,5	0,02		12



84840



84841

Schale „MINI LEAF“

bowl
cuenco
bol



	cm	↑ cm	ltr.	Farbe / Colour	VE / unit
84840	10,5 x 7,5	2,5	0,04		40
84841	10,5 x 7,5	2,5	0,04		40



84842



84843

Schale „MINI LEAF“

bowl
cuenco
bol



	cm	↑ cm	ltr.	Farbe / Colour	VE / unit
84842	10,5 x 6,5	4,5	0,06		40
84843	10,5 x 6,5	4,5	0,06		40



84844



84845

Schale „MINI LEAF“

bowl
cuenco
bol



	cm	↑ cm	ltr.	Farbe / Colour	VE / unit
84844	14,5 x 6,0	3,0	0,05		40
84845	14,5 x 6,0	3,0	0,05		40



Schale „MINI“
bowl
cuenco
bol

original
APS
melamine

MAX
70°C

Farbe / Colour

	cm	↑ cm	ltr.	Farbe / Colour	VE / unit
84750	8 x 8	3	0,06	White	24
84760	8 x 8	3	0,06	Blue	24



Schale „MINI“
bowl
cuenco
bol

original
APS
melamine

MAX
70°C

Farbe / Colour

	cm	↑ cm	ltr.	Farbe / Colour	VE / unit
84751	9,5 x 9,5	3	0,1	White	24
84761	9,5 x 9,5	3	0,1	Blue	24



Schale „MINI“
bowl
cuenco
bol

original
APS
melamine

MAX
70°C

Farbe / Colour

	cm	↑ cm	ltr.	Farbe / Colour	VE / unit
84752	9,5 x 8	3	0,08	White	24
84762	9,5 x 8	3	0,08	Blue	24



Schale / Schiffchen „MINI“
bowl
cuenco
bol

original
APS
melamine

MAX
70°C

Farbe / Colour

	cm	↑ cm	ltr.	Farbe / Colour	VE / unit
84753	12,5 x 5,5	4	0,06	White	24
84763	12,5 x 5,5	4	0,06	Blue	24



Schale / Schiffchen „MINI“
bowl
cuenco
bol

original
APS
melamine

MAX
70°C

Farbe / Colour

	cm	↑ cm	ltr.	Farbe / Colour	VE / unit
84754	14 x 6,5	4	0,1	White	24
84764	14 x 6,5	4	0,1	Blue	24



Teller „MINI“
plate
plato
assiette



	cm	↑ cm	ltr.	VE / unit
84444	10,5 x 8,5	2,0	0,07	20

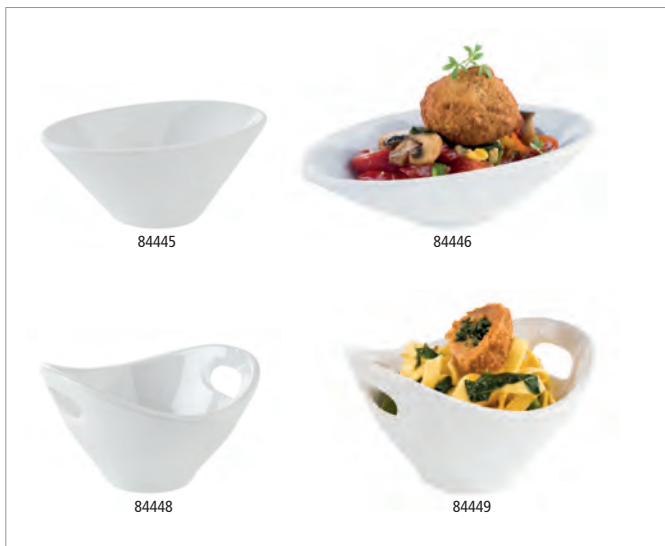

Schale „MINI“
bowl
cuenco
bol



	cm	↑ cm	ltr.	VE / unit
84445	10,5 x 6,0	4,0	0,07	20
84446	13,5 x 7,5	3,0	0,07	20
84448	9,5 x 9,0	5,5	0,09	20
84449	13,0 x 12,0	7,5	0,18	20



Schale „MINI“
bowl
cuenco
bol



	Ø cm	↑ cm	ltr.	Farbe / Colour
84775	8,5	2,5	0,07	White
84778	8,5	2,5	0,07	Black
84781	8,5	2,5	0,07	Dark Grey



Schale „MINI“
bowl
cuenco
bol



	Ø cm	↑ cm	ltr.	Farbe / Colour
84776	8,5	2,5	0,07	White
84779	8,5	2,5	0,07	Black
84782	8,5	2,5	0,07	Dark Grey



Schale „MINI“
bowl
cuenco
bol



	cm	↑ cm	ltr.	Farbe / Colour
84777	9,5 x 5,5	5,5	0,07	White
84780	9,5 x 5,5	5,5	0,07	Black
84783	9,5 x 5,5	5,5	0,07	Dark Grey



Schale „MINI“
bowl
cuenco
bol



	cm	↑ cm	ltr.	VE / unit
84452	11,5 x 7,5	3,0	0,06	24
84454	11,5 x 6,0	5,5	0,04	24
84456	8,5 x 7,0	6,0	0,07	24
84458	8,0 x 8,0	4,0	0,10	24
84450	7,5 x 7,0	4,5	0,05	24

Schälchen „GOURMET“ / bowl / cuenco / bol

	Ø cm	↑ cm	ltr.
84018	7	6	0,05

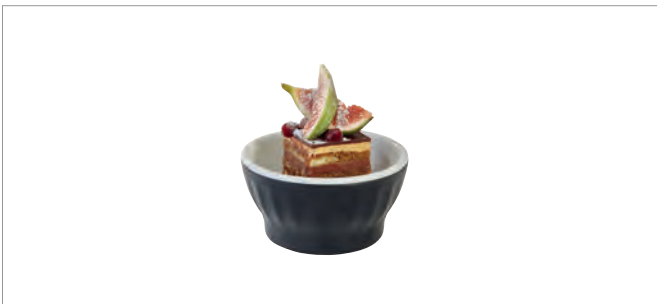

Schale „HALFTONE“
bowl
cuenco
bol



	Ø cm	↑ cm	ltr.	VE / unit
84217	8,0	4,0	0,1	12



Schale „MINI“
bowl
cuenco
bol



	cm	↑ cm	ltr.	VE / unit
84460	35 x 4,5	3	0,20	10



Tablett „GOURMET“
tray
bandeja
plateau



mit 3 Absätzen Ø 4 cm
with 3 holes Ø 4 cm
con 3 agujeros Ø 4 cm
avec 3 trous Ø 4 cm

	cm	↑ cm
84017	30,5 x 9,5	2,5

Schälchen „GOURMET“ / bowl / cuenco / bol

	Ø cm	↑ cm	ltr.
84018	7	6	0,05

hot price



GN 2/4



GN 1/1



GN 1/2



GN 1/4



GN 1/6

GN-Behälter „ECOLINE“

GN container
GN cubeta
GN bac



	GN	↓ mm	ltr.	cm	Farbe / Colour
83759	1/1	65	7,10	53,0 x 32,5	White
83755	2/4	65	3,00	53,0 x 16,2	White
83757	1/2	65	3,40	32,5 x 26,5	White
83753	1/3	65	2,00	32,5 x 17,6	White
83751	1/4	65	1,35	26,5 x 16,2	White
83749	1/6	65	0,80	17,6 x 16,2	White

	GN	↓ mm	ltr.	cm	Farbe / Colour
83758	1/1	65	7,10	53,0 x 32,5	Black
83754	2/4	65	3,00	53,0 x 16,2	Black
83756	1/2	65	3,40	32,5 x 26,5	Black
83752	1/3	65	2,00	32,5 x 17,6	Black
83750	1/4	65	1,35	26,5 x 16,2	Black
83748	1/6	65	0,80	17,6 x 16,2	Black

	GN	↓ mm	ltr.	cm	Farbe / Colour
84300	1/1	100	10,6	53,0 x 32,5	White
84302	2/4	100	4,3	53,0 x 16,2	White
84301	1/2	100	4,7	32,5 x 26,5	White
84303	1/3	100	2,7	32,5 x 17,6	White
84304	1/4	100	1,9	26,5 x 16,2	White
84305	1/6	100	1,0	17,6 x 16,2	White

	GN	↓ mm	ltr.	cm	Farbe / Colour
84306	1/1	100	10,6	53,0 x 32,5	Black
84308	2/4	100	4,3	53,0 x 16,2	Black
84307	1/2	100	4,7	32,5 x 26,5	Black
84309	1/3	100	2,7	32,5 x 17,6	Black
84310	1/4	100	1,9	26,5 x 16,2	Black
84311	1/6	100	1,0	17,6 x 16,2	Black

GN-Behälter „HIGHLINE“

GN-container
GN cubeta
GN bac



	GN	↓ mm	ltr.	cm
83772	1/1	65	7,10	53,0 x 32,5
83770	2/3	65	4,60	35,0 x 32,5
83768	1/2	65	3,40	32,5 x 26,5
83766	2/4	65	3,00	53,0 x 16,2
83764	1/3	65	2,00	32,5 x 17,6
83762	1/4	65	1,35	26,5 x 16,2
83760	1/6	65	0,80	17,6 x 16,2

	GN	↓ mm	ltr.	cm
83773	1/1	100	11,0	53,0 x 32,5
83769	1/2	100	5,50	32,5 x 26,5
83765	1/3	100	3,15	32,5 x 17,6
83763	1/4	100	2,20	26,5 x 16,2
83761	1/6	100	1,25	17,6 x 16,2



83762



83763





Tableware Table Presentation

NEW LEVANTE



Levante Küche passend serviert!

Viel Gemüse, wenig Fleisch und eine Vielfalt an Gewürzen charakterisieren die Küche des Nahen Ostens. Der östliche Mittelmeerraum, also Syrien, Libanon, Jordanien, Israel und Palästina wird als Levante bezeichnet. Als Levante-Küche wird die Essenstradition dieser Länder als Food-Trend gefeiert.

Levantine cuisine served appropriately!

Lots of vegetables, little meat and a variety of spices characterise the cuisine of the Middle East. The eastern Mediterranean region, i. e. Syria, Lebanon, Jordan, Israel and Palestine is referred to as the Levant. As Levantine cuisine, the food tradition of these countries is celebrated as a food trend.

Cocina levantina servida como es debido.

Mucha verdura, poca carne y una gran variedad de especias caracterizan la cocina de Oriente Medio. La región del Mediterráneo oriental, es decir, Siria, Líbano, Jordania, Israel y Palestina, se denomina Levante. La cocina levantina, la tradición alimentaria de estos países, se celebra como una tendencia alimentaria.

Cuisine levantine servie comme il se doit!

Beaucoup de légumes, peu de viande et une variété d'épices caractérisent la cuisine du Moyen-Orient. La région de la Méditerranée orientale, c'est-à-dire la Syrie, le Liban, la Jordanie, Israël et la Palestine, est appelée le Levant. La tradition alimentaire de ces pays, la cuisine levantine, est célébrée comme une tendance alimentaire.



Schale „LEVANTE“

bowl
cuenco
bol



	Ø cm	↑ cm	ltr.	Farbe / Colour
40700	9,5	4,5	0,14	
40701	9,5	4,5	0,14	
40702	12	6,5	0,32	
40703	12	6,5	0,32	
40704	17	8,5	0,90	
40705	17	8,5	0,90	



stapelbar stackable copper red grey black



Schale „LEVANTE“

bowl
cuenco
bol



	Ø cm	↑ cm	ltr.	Farbe / Colour
40706	7,5	2,5	0,05	
40707	7,5	2,5	0,05	
40708	8,5	5,5	0,20	
40709	8,5	5,5	0,20	
40710	8,5	8,5	0,40	
40711	8,5	8,5	0,40	



copper red
 grey black

Präsentationsmöglichkeit
presentation example



Tablett „LEVANTE“

tray
bandeja
GN plateau



	cm	↑ cm	ltr.	Farbe / Colour
40712	26,5 x 16	3	0,70	
40713	26,5 x 16	3	0,70	



copper red
 grey black

Präsentationsmöglichkeit
presentation example



SUPER CUP

Der transparente Becher aus **recyclebarem** Kunststoff ist vielseitig einsetzbar:

- Buffet
- Catering
- Kantine
- Bäckerei & Coffee Shop
- Pool & Beach

Mehrweg
statt Einweg
TO GO ! ...



Eigenschaften:

- aus schlagfestem, transp. Kunststoff
- leichter als Glas
- nahezu unzerbrechlich
- für kalte und warme Speisen
- Gebrauchstemperatur bis +80°C
- langlebig und ökologisch sinnvoll



250 ml

Becher Set „SUPER CUP“, 16-tlg.

barrel mug set, 16 pcs.
vasos, set de 16
gobelets, set de 16

16-teiliges Set: 8 Becher + 8 Deckel
16 pcs. set: 8 barrel mugs + 8 lids
set de 16: 8 vasos + 8 tapas
set de 16: 8 gobelets + 8 couvercles



IDEAL
FÜR
„TAKE AWAY“

	Ø cm	↑ cm	ltr.
10506	8	10	0,25



mit Stapelnocke
with stacking cam



rutschfester Deckel
non-slip lid



0,05 ltr.

40642

0,32 ltr.

40644

Stielkasserolle / Serviertopf

sauté pan / mini sauce pan
cazo recto bajo
plat à sauter



	Ø cm	↑ cm	ltr.	Griff / handle cm
40642	5,5	2,5	0,05	6
40643	7,0	3,5	0,12	8,5
40644	9,5	5,5	0,32	8,5

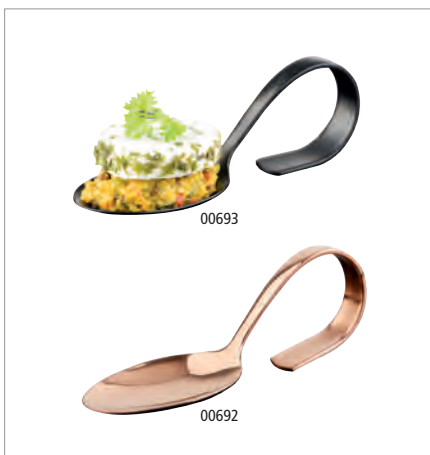

00693

00692

Gourmet-Löffel „CLASSIC“

party spoon
cuchara gourmet
cuillère gourmet



	cm		
00693	12,0	gunmetal look	PVD coated stainless steel
00677	13,5	stainless steel look	
00691	12,0	Gold-Look / gold look	PVD coated stainless steel
00692	12,0	Kupfer-Look / copper look	PVD coated stainless steel

SERVING TROWEL *super trendy*



40680

40681

Servierkelle „BOB“

serving trowel
paleta para servir
truelle de service



Edelstahl Servierkelle mit schwarzem Holzgriff

stainless steel serving trowel with black wooden handle
paleta para servir de acero inoxidable con mango de madera negra
truelle de service en acier inox avec manche en bois noir

	cm	↑ cm	Griff / handle cm	
40680	23,5 x 15,5	12,5	13,5	stainless steel
40681	23,5 x 15,5	12,5	13,5	■



40675

40676

Snackbox „INDUSTRIAL“

snack box
caja tentempié
casse-croûte



Metall, schwarz
metal, black
metal, negro
métal, noir

	cm	↑ cm	ltr.
40675	16,5 x 10,5	7,50	0,5
40676	23,0 x 15,5	13,0	2,4



stapelbar
stackable

CAST IRON



Die Servierpfännchen aus emailliertem Gusseisen dienen dem portionsweisen Servieren und halten die Speisen warm.

The serving pans made of enameled cast iron are used for serving in portions and for keeping the food warm.

Las fuentes de hierro fundido esmaltado se utilizan para servir en porciones y mantener la comida caliente.

Les plateaux de service en fonte émaillée sont utilisés pour servir en portions et garder les aliments au chaud.



Servierpfännchen „CAST IRON“

serving pan
fuente para servir
plat de service



Gusseisen emailliert
enameled cast iron
hierro fundido esmaltado
fonte émaillée

	∅ cm	↑ cm	Farbe / Colour
88220	10	2	
88225	10	2	
88221	13	2	
88226	13	2	



Servierpfännchen „CAST IRON“

serving pan
fuente para servir
plat de service



Gusseisen emailliert
enameled cast iron
hierro fundido esmaltado
fonte émaillée

	cm	↑ cm	Farbe / Colour
88222	13 x 13	2	
88227	13 x 13	2	
88223	16 x 13	2	
88228	16 x 13	2	
88224	20 x 13	2	
88229	20 x 13	2	



SNACKHOLDER



Gold: made from PVD coated stainless steel

Die Mini-Edelstahlkörbchen dienen dem portionsweisen Servieren. Zum originellen Servieren von Beilagen geeignet, aber auch zum Frittieren selbst.

The mini frying baskets are used to present individual portions in an original way, but can still be used to fry.

Las cestas de freir ofrecen una presentación original para el servicio de tapas o raciones individuales de patatas, aperitivos, fritos, etc.

Les paniers à friture offrent une présentation originale pour servir apéritifs, snacks, tapas et autres rations individuelles. Également aptes pour frire.



Servier-Frittierkorb „SNACKHOLDER“

stainless steel fry baskets
cestitas inox para el servicio mesa
paniers inox pour le service sur table



	Ø cm	↑ cm	Griff / handle cm	Farbe / Colour	
40600	8	7,5	9,5		stainless steel
40602	8	7,5	9,5		gold
40601	9	8,5	9,0		stainless steel
40603	9	8,5	9,0		gold



Servier-Frittierkorb „SNACKHOLDER“

stainless steel fry baskets
cestitas inox para el servicio mesa
paniers inox pour le service sur table



	cm	↑ cm	Griff / handle cm	Farbe / Colour	
40610	21,5 x 10,5	4,5	9,5		stainless steel
40612	21,5 x 10,5	4,5	9,5		gold
40611	26,0 x 13,0	5,0	9,0		stainless steel
40613	26,0 x 13,0	5,0	9,0		gold



Servier-Frittierkorb „SNACKHOLDER“

stainless steel fry baskets
cestitas inox para el servicio mesa
paniers inox pour le service sur table



	cm	↑ cm	Griff / handle cm	Farbe / Colour	
40620	10,0 x 8,5	6,5	9,0		stainless steel
40622	10,0 x 8,5	6,5	9,0		gold
40621	13,0 x 10,5	9,0	13,5		stainless steel
40623	13,0 x 10,5	9,0	13,5		gold

SNACKHOLDER



Snackholder
serving cup
vaso para servir
gobelet à apéritif



	Ø cm	↑ cm	ltr.	Farbe / Colour	
40616	9,5	8,5 / 11,5	0,45		Edelstahl Kupfer / stainless copper
40617	8,5	8,5	0,35		Edelstahl Kupfer / stainless copper
40618	8,5	8,5	0,35		gehämmerte Oberfläche / hammered
40605	9,5	8,5 / 11,5	0,45		Edelstahl / stainless steel
40606	8,5	8,5	0,35		Edelstahl / stainless steel
40607	8,5	8,5	0,35		gehämmerte Oberfläche / hammered



Servier- / Saucen-Eimer „SNACKHOLDER“
mini stainless steel bucket
cubo inox en formato mini
seau mini inox



	Ø cm	↑ cm	ltr.	pcs
40630	7	6,5	0,15	4
40631	9	8,5	0,33	1



Mini-Milchkanne „SNACKHOLDER“ 4er Set
mini milk can, 4 pcs.
lechera en formato mini, set de 4
pot à lait mini, set de 4



	Ø cm	↑ cm	ltr.	pcs.
40640	4,5	5	0,08	4



Mini-Servierpfanne „SNACKHOLDER“
mini pan
sartén en formato mini
poêle à frire mini



	cm	↑ cm	ltr.
40660	14,5 x 9,5	4,5 / 6,5	0,5



Snackcan

serving can

lata para aperitivos

boîte de conserves pour apéritifs



	Ø cm	↑ cm	ltr.	
40654	6,5	4,0	0,12	ideale Beilagen Größe
40655	7,5	5,5	0,17	
40656	7,5	10,0	0,35	
40659	12,0	8,0	0,80	
40658	13,5	14,0	1,80	
40657	13,5	10,5	1,30	



Schale

bowl

cuenco

bol



	Ø cm	↑ cm	ltr.
40685	6	3,0	0,05
40686	8	4,5	0,17

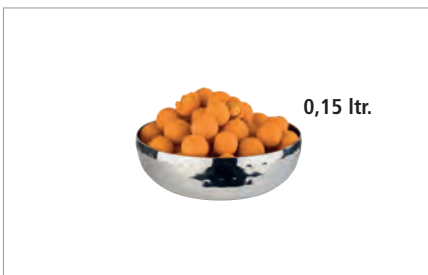

Schale

bowl

cuenco

bol



gehämmerte Oberfläche / hammered surface / superficie martillada / surface martelée

	Ø cm	↑ cm	ltr.
40185	9,5	3	0,15



Serviertöpfchen

small serving pot

olla pequeña de servir

marmite petite de servir



gehämmerte Oberfläche

hammered surface

superficie martillada

surface martelée

	Ø cm	↑ cm	ltr.	Griff / handle cm
40186	9,5	5,5	0,30	2,5
40187	13,5	5,0	0,55	3,0
40188	15,5	5,0	0,75	3,0

SNACKHOLDER

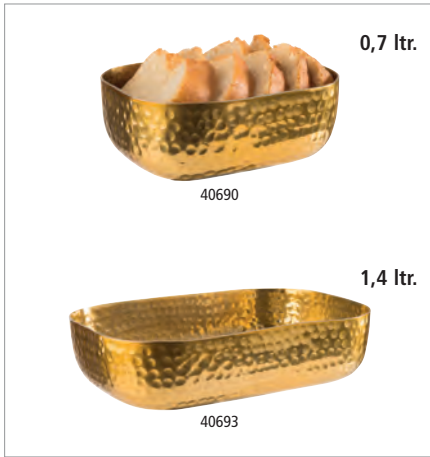

Schale

bowl
cuenco
bol



gehämmerte Oberfläche
hammered surface
superficie martillada
surface martelée

	cm	↑ cm	ltr.	Farbe / Colour
40690	15,5 x 12,0	5,5	0,7	gold look
40693	23,0 x 15,5	6,0	1,4	gold look

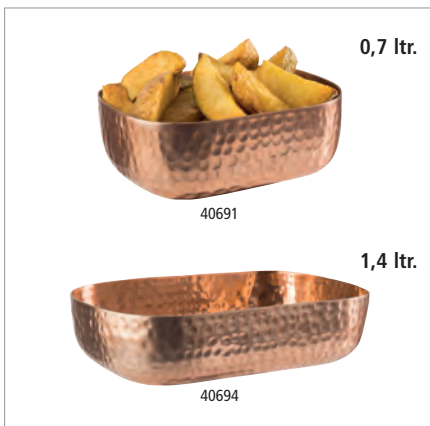

Schale

bowl
cuenco
bol



gehämmerte Oberfläche
hammered surface
superficie martillada
surface martelée

	cm	↑ cm	ltr.	Farbe / Colour
40691	15,5 x 12,0	5,5	0,7	copper look
40694	23,0 x 15,5	6,0	1,4	copper look



Schale

bowl
cuenco
bol



gehämmerte Oberfläche
hammered surface
superficie martillada
surface martelée

	cm	↑ cm	ltr.	Farbe / Colour
40692	15,5 x 12,0	5,5	0,7	gunmetal-look
40695	23,0 x 15,5	6,0	1,4	gunmetal-look



Servierkorb „BURGER & FRIES“

serving basket
cesta para servir
corbeille de service



Servierkorb aus Metall mit 2 Haltern für Dipschälchen

metal serving basket with 2 holders for dip bowls

cesta de metal para servir con 2 soportes para cuencos para dip

corbeille de service en métal avec 2 supports pour ramequins

	cm	↑ cm
40604	39,5 x 20	11

passende Schälchen / fitting bowls / cuencos adecuados / bols apropiés



	ø cm	↑ cm	ltr.	VE / unit
83781	7	3,7	0,05	24

NEW



01010 **0,15 ltr.**



01011 **0,25 ltr.**



01012 **0,50 ltr.**

Schale „OLIVE“

bowl
cuenco
bol



aus geöltem Olivenholz
oiled olive wood
de madera de olivo aceitada
en bois d'olivier huilé

	Ø cm	↑ cm	ltr.
01010	10,0	4,0	0,15
01011	12,5	4,5	0,25
01012	15,0	6,0	0,50



3 Größen ineinander
3 sizes in each other

NEW



01013 **0,05 ltr.**



01014 **0,15 ltr.**



01015 **0,60 ltr.**

Schale „OLIVE“

bowl
cuenco
bol



aus geöltem Olivenholz
oiled olive wood
de madera de olivo aceitada
en bois d'olivier huilé

	cm	↑ cm	ltr.
01013	7,5 x 7,5	2,5	0,05
01014	17,5 x 8,5	2,5	0,15
01015	26,5 x 11,5	5,0	0,60

NEW



01023 **0,4 ltr.**

Schale „OLIVE“

bowl
cuenco
bol



aus geöltem Olivenholz
oiled olive wood
de madera de olivo aceitada
en bois d'olivier huilé

	cm	↑ cm	ltr.
01023	25 x 8,5	7,5	0,40



00843 **0,05 ltr.**



00844 **0,10 ltr.**

Schale „OLIVE“

bowl
cuenco
bol



aus geöltem Olivenholz
oiled olive wood
de madera de olivo aceitada
en bois d'olivier huilé

	cm	↑ cm	ltr.
00843	12,0 x 7,5	2,5	0,05
00844	16,5 x 9,5	2,5	0,10

SNACKHOLDER · SERVING BOARD



Schale „OLIVE“

bowl
cuenco
bol



aus geöltem Olivenholz
oiled olive wood
de madera de olivo aceitada
en bois d'olivier huilé

	cm	↑ cm	ltr.
00907	13 x 8	6,5	0,20
00908	16 x 9	7,0	0,30



Servierbrett „OLIVE“

serving board
tabla de servir
planche de service



aus geöltem Olivenholz
oiled olive wood
de madera de olivo aceitada
en bois d'olivier huilé

	cm	↑ cm
01022	39,5 x 21	2,5
01021	35,5 x 18,5	2,0



Servierbrett „OLIVE“

serving board
tabla de servir
planche de service



aus geöltem Olivenholz
oiled olive wood
de madera de olivo aceitada
en bois d'olivier huilé

	cm	↑ cm
00905	25,5 x 16,5	1,5
00906	35,0 x 20,5	1,5



Servierbrett „OAK“

serving board
tabla de servir
planche de service



aus geöltem Eichenholz, Safrille, ø 9,5 cm Aussparung
made of oiled oak, with juice groove, with hole ø 9.5 cm
de madera de roble aceitada, con ranura para líquidos, con agujero ø 9,5 cm
en bois chêne huilé, avec rigole, avec trou ø 9,5 cm

	cm	↑ cm
00808	37 x 25	2



mit Safrille / with juice groove



Naturschieferplatte

natural slate tray
bandeja pizarra natural
plat ardoise naturelle



mit Absatz Ø 6 cm
with hole Ø 6 cm
con agujero Ø 6 cm
avec trou Ø 6,0 cm

cm * mm
00986 25 x 12 6 - 9



Naturschieferplatte

natural slate tray
bandeja pizarra natural
plat ardoise naturelle



mit 3 Absätzen, Ø 6 cm
with 3 holes, Ø 6 cm
con 3 agujeros, Ø 6 cm
avec 3 trous, Ø 6 cm

cm * mm
00987 28 x 10 6 - 9



Naturschieferplatte „STARTER“

natural slate tray
bandeja de pizarra natural
plat ardoise naturelle carré



cm * mm
00937 20 x 10 6 - 9



Naturschieferplatte / Untersetzer

natural slate tray
bandeja de pizarra natural
plateau ardoise naturelle



mit 2 Absätzen Ø 6 cm
with 2 holes Ø 6 cm
con 2 agujeros Ø 6 cm
avec 2 trous Ø 6 cm

cm * mm
00971 15 x 8 6 - 9



Naturschieferplatte, 2-teilig

natural slate tray, 2 pcs. set
bandeja de pizarra natural y campana
plateau ardoise naturelle et cloche en verre



mit Glashaube
with glass cover
con tapa de cristal
avec cloche en verre

cm * mm
00984 10,5 8 6 - 9

SERVING BOARD

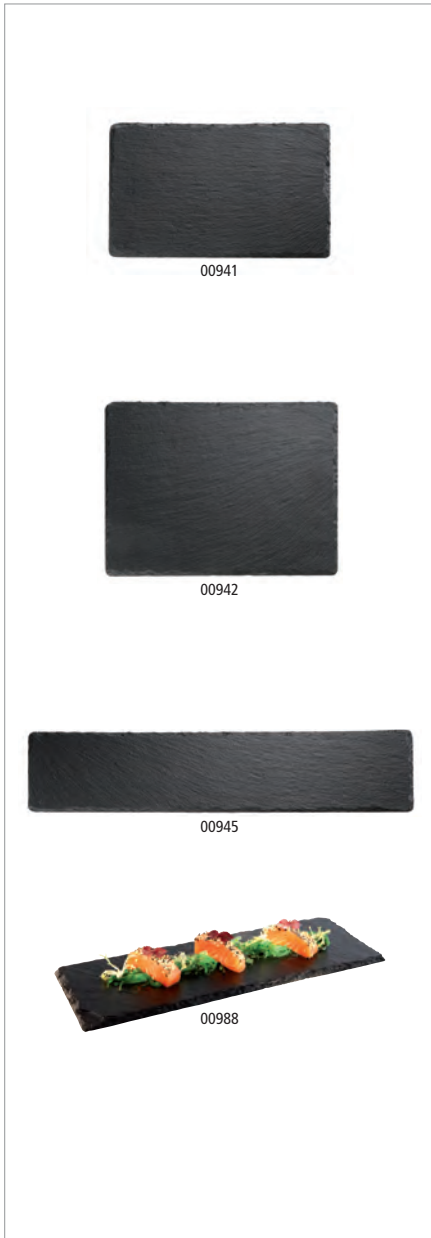

Naturschieferplatte

natural slate
bandeja de pizarra natural
plateau ardoise naturelle



	cm	* mm
00941	24,0 x 15,0	6 - 9
00942	26,5 x 20,5	6 - 9
00945	47,0 x 10,0	6 - 9
00988	30,0 x 12,0	6 - 9

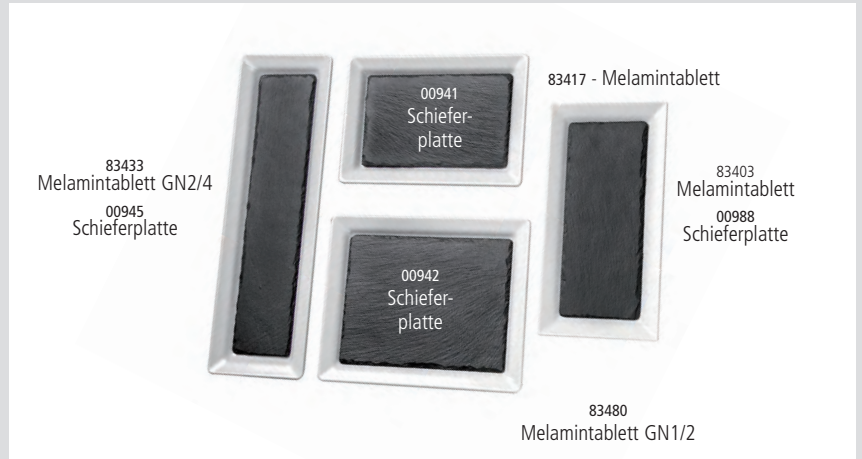

Naturschieferplatte

natural slate tray
bandeja de pizarra natural
plat ardoise naturelle



	cm	* mm
00996	45 x 30	6 - 9



Naturschieferplatte

natural slate tray
bandeja de pizarra natural
plat ardoise naturelle



	cm	* mm
00994	25 x 25	6 - 9
00995	30 x 30	6 - 9

**Servierbrett „SHARING“**

serving board
tabla de servir
planche de service



Servierbrett aus geöltem Akazienholz

serving board made of oiled acacia wood
tabla de servir de madera de acacia aceitada
planche en bois d'acacia huilé

	cm	↑ cm	Griff / handle cm
00887	51,5 x 18	1,5	8,5

**Servierbrett „AKAZIE-SCHIEFER“**

serving board
tabla de servir
planche de service



raffiniertes, rustikales Servierbrett
aus Akazienholz, ausgestattet mit einem Naturschieferstreifen
zur Kennzeichnung

wood with slate, markable
madera con pizarra, se puede marcar
bois avec ardoise, on peut mettre une inscription

	cm	↑ cm	Griff / handle cm
00867	30,5 x 13	1,5	10
00868	36,5 x 15	1,5	12
00869	42,0 x 18	1,5	14

**Servierbrett „OLIVE“**

serving board
tabla de servir
planche de service



Servierbrett im Naturschnitt, aus Olivenholz. Jedes Brett
wird handgefertigt und geölt mit 19 mm Aufhäng Bohrung.
Alle Produkte unterscheiden sich naturbedingt in Form,
Maserung und Größe!

Olive Wood is known for its versatility and striking appearance
with each piece having its own unique features.

El olivo es conocido por su versatilidad y aspecto espectacular y
único en cada pieza. Por su fabricación a mano de forma artesanal,
todas las piezas varían en tamaño, forma y acabado, lo que hace de
cada una un ejemplar único.

Le bois d'olivier est reconnu pour sa versatilité et son esthétique
spectaculaire. De par leur fabrication artisanale à la main, toutes
les pièces varient quant à leur taille, forme et finition, de telle sorte
que chacune est un exemplaire unique.

	cm	↑ cm	Griff / handle cm
00870	25,0 x 17,0	1,5	
00871	30,0 x 20,5	2,0	
00872	35,0 x 24,0	2,0	
00873	40,0 x 15,0	1,5	11
00874	44,0 x 20,0	2,0	12
00875	19,0 x 12,5	1,5	6
00876	25,0 x 16,0	1,5	8
00877	31,0 x 20,0	1,5	9

SERVING BOARD



Servierbrett „NARROW I“

serving board
tabla de servir
planche de service



Akazienholz, mit 3 Vertiefungen Ø 4 cm
acacia wood, with 3 notches Ø 4 cm
madera de acacia, con 3 ranuras Ø 4 cm
bois d'acacia, avec 3 encoches Ø 4 cm

	cm	↑ cm
00864	22 x 8	1,5

passende Schälchen / fitting bowls / cuencos adecuados / bols apropiés

	Ø cm	↑ cm	ltr.	
82312	6	5,5	0,08	glass / 12 pcs
40685	6	3,0	0,05	stainless steel



Servierbrett „NARROW“

serving board
tabla de servir
planche de service



Akazienholz, mit 3 Vertiefungen Ø 6 cm
acacia wood, with 3 notches Ø 6 cm
madera de acacia, con 3 ranuras Ø 6 cm
bois d'acacia, avec 3 encoches Ø 6 cm

	cm	↑ cm
00878	31 x 11	2

passende Schälchen / fitting bowls / cuencos adecuados / bols apropiés

	Ø cm	↑ cm	ltr.	
40686	8	4,5	0,17	stainless steel
82316	7	8	0,22	glass / 12 pcs



Tablett

tray
bandeja
plateau



aus Bambus, geeignet zum Servieren und Transportieren
made of bamboo, suitable for serving and transport
de bambú, para servir y transportar
en bambou, pour servir et transporter

	cm	↑ cm	GN
00845	32,5 x 26,5	3	1/2
00846	32,5 x 17,6	3	1/3
00847	53,0 x 16,2	3	2/4





mit Absatz Ø 5 cm
with hole Ø 5 cm

Servierbrett, 2-teilig

serving board, 2 pcs. set
tabla de servir, set de 2
planche de service, set de 2

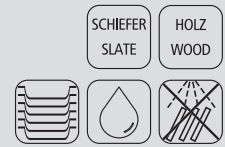

2-teilig:

1 Holzbrett aus Akazienholz + 1 Naturschieferplatte

1 wood board made of acacia wood + 1 natural slate tray

1 tabla de madera de acacia + 1 pizarra natural

1 planche en bois d'acacia + 1 ardoise naturelle

	cm	↑ cm
00814	28 x 17,5	2



Servierbrett

serving board
tabla de servir
planche de service



Servierbrett aus geöltem Akazienholz

serving board made of oiled acacia wood

tabla de servir de madera de acacia aceitada

planche en bois avec plateau en bois d'acacia huilé

	cm	↑ cm
00897	30 x 15	2
00898	30 x 18	2
00899	35 x 25	2



Servierbrett, 2-teilig

serving board, 2 pcs. set
tabla de servir, set de 2
planche de service, set de 2



2-teilig:

Ein rustikales Servierbrett aus Akazienholz,
ausgestattet mit einer Naturschieferplatte

wood board oiled acacia with a slate tray

tabla de madera de acacia con una bandeja de pizarra natural

planche en bois d'acacia avec un plateau en ardoise naturelle

	cm	↑ cm	Griff / handle cm
00810	26 x 18	2	8
00811	33 x 20	2	8
00812	40 x 15	2	5
00813	43 x 12	2	12

Präsentationsmöglichkeit
presentation example



mit Hängeloch Ø 2 cm / with a handle-hole Ø 2 cm

SERVING BOARD



Tablett „VINTAGE“

tray
bandeja
plateau



Antik-Edelstahl-Look
stainless steel antique look
acero estilo antiguo
acier style antique

	cm	↑ cm
30130	26,0 x 13,5	1,5
30131	34,0 x 18,0	1,5
30132	38,0 x 26,5	1,5
30133	25,5 x 16,0	3,0

passende Schälchen / fitting bowls / cuencos adecuados / bols apropiés



	Ø cm	↑ cm	ltr.
40655	7,5	5,5	0,17
40656	7,5	10,0	0,35



Servierbeispiel
serving example

passendes Wachspapier / greaseproof paper squares / papel alimenticio para cucurucho / papier alimentaire pour cornet

	cm	pcs.	
40670	42 x 25	500	Motiv: Zeitung
40671	42 x 25	500	blank
<hr/>			
	cm	pcs.	
40672	42 x 25	500	Motiv: rote Karos / red
40673	42 x 25	500	Motiv: blaue Karos / blue
40674	30 x 20	500	Motiv: Fast Food / black

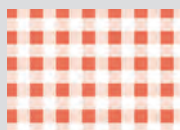

40672



40673



40674

Tablett „TREND“

baking sheet
bandeja
plateau



ein Backblech wird zum Serviertablett
a baking sheet which becomes a serving tray
una bandeja de hornear que se convierte en una bandeja de servir
un moule qui devient un plateau de service

	cm	↑ cm
13380	32 x 21,5	2

NEW



01016



01017

Wachspapier
40677**SNACKBOX „OLIVE“**snackbox
snackbox
snackboxaus geöltem Olivenholz
oiled olive wood
de madera de olivo aceitada
en bois d'olivier huilé

	cm	↑ cm
01016	22 x 15	6
01017	25 x 18	6



01016



01016



40675

Snackbox „INDUSTRIAL“snack box
caja tentempié
casse-croûteMetall, schwarz
metal, black
metal, negro
métal, noir

	cm	↑ cm	litr.
40675	16,5 x 10,5	7,5	0,5
40676	23,0 x 15,5	13,0	2,4

Holzbox „TABLE“woodbox
caja madera
base boisAkazienholz, 3 Fächer (6,5 x 6,5 cm)
acacia wood, 3 compartments (6,5 x 6,5 cm)
madera de acacia, 3 compartimentos (6,5 x 6,5 cm)
bois d'acacia, 3 compartiments (6,5 x 6,5 cm)Servierbeispiel - Lieferung ohne Gläser
delivery without glasses

	cm	↑ cm	inner size cm
11727	23,5 x 8,5	4,5	6,5 x 6,5 je Fach / each compartment

Holzbox „TABLE“woodbox
caja madera
base boisAkazienholz, natur
acacia wood, nature
madera de acacia, natural
bois d'acacia, naturel

40556

40555

	cm	↑ cm	inner size cm
11726	15 x 9,5	5	12 x 6,5

GRAESERPROOF PAPER SQUARE



Snackbox „DUO“

snackbox
snackbox
snackbox



Behälter aus Metall mit Tragegriff aus Holz
container made of metal with wooden handle
contenedor de metal con asa de madera
conteneur métallique avec poignée en bois

	cm	↑ cm
00014	24,5 x 12	18,5



Wachspapier „SNACKHOLDER“

greaseproof paper squares
papel alimenticio para cucurucho
papier alimentaire pour cornet



	cm	pcs.	
40670	42 x 25	500	Motiv: Zeitung
40671	42 x 25	500	blanco
40672	42 x 25	500	Motiv: rote Karos / red
40673	42 x 25	500	Motiv: blaue Karos / blue
40674	30 x 20	500	Motiv: Fast Food / black
40677	25 x 20	1000	Motiv: Zeitung
40678	31 x 31	1000	Motiv: Zeitung
40679	34 x 28	1000	Motiv: Zeitung

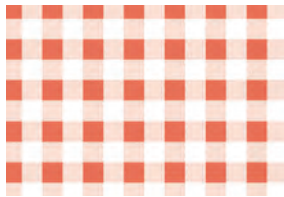

40672

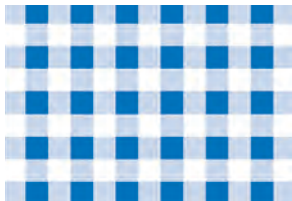

40673



40674



40678



40674



40677



40678



40679



40656

40655

30132



13380



Pfeffermühle „COPPER“

pepper mill
molinillo de pimienta
moulin à poivre



Mahlwerk aus Carbonstahl, Mahlgrad stufenlos einstellbar

mill in carbon steel, the grinding degree can be adjusted infinitely
molinillo de acero al carbono, el grado de molino se puede ajustar de modo continuo
moulin en acier de carbone, la finesse de mouture se peut réglée de façon continue

	Ø cm	↑ cm
40551	6	15

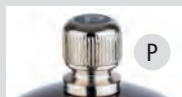

Salzmühle „COPPER“

salt mill
molinillo de sal
moulin à sel



Mahlwerk aus Edelstahl, Mahlgrad stufenlos einstellbar

mill in stainless steel, the grinding degree can be adjusted infinitely
molinillo de acero inoxidable, el grado de molino se puede ajustar de modo continuo
moulin en acier inox, la finesse de mouture se peut réglée de façon continue

	Ø cm	↑ cm
40552	6	15



Pfeffermühle „FRIDA“

pepper mill
molinillo de pimienta
moulin à poivre

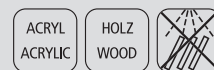

Mahlwerk aus Carbonstahl, Mahlgrad stufenlos einstellbar

mill in carbon steel, the grinding degree can be adjusted infinitely
molinillo de acero al carbono, el grado de molino se puede ajustar de modo continuo
moulin en acier de carbone, la finesse de mouture se peut réglée de façon continue

	Ø cm	↑ cm
40549	6	15,5

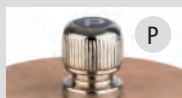

Salzmühle „FRIDA“

salt mill
molinillo de sal
moulin à sel

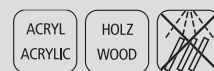

Mahlwerk aus Edelstahl, Mahlgrad stufenlos einstellbar

mill in stainless steel, the grinding degree can be adjusted infinitely
molinillo de acero inoxidable, el grado de molino se puede ajustar de modo continuo
moulin en acier inox, la finesse de mouture se peut réglée de façon continue

	Ø cm	↑ cm
40550	6	15,5



PEPPER, - SALT MILL



Pfeffermühle „DIAMOND“

pepper mill
molinillo de pimienta
moulin à poivre



Mahlwerk aus Carbonstahl, Mahlgrad stufenlos einstellbar

mill in carbon steel, the grinding degree can be adjusted infinitely

molinillo de acero al carbono, el grado de molino se puede ajustar de modo continuo

moulin en acier de carbone, la finesse de mouture se peut régler de façon continue

	Ø cm	↑ cm
40553	6	18



Salzmühle „DIAMOND“

salt mill
molinillo de sal
moulin à sel



Mahlwerk aus Edelstahl, Mahlgrad stufenlos einstellbar

mill in stainless steel, the grinding degree can be adjusted infinitely

molinillo de acero inoxidable, el grado de molino se puede ajustar de modo continuo

moulin en acier inox, la finesse de mouture se peut régler de façon continue

	Ø cm	↑ cm
40554	6	18



Pfeffermühle „GUNMETAL“

pepper mill
molinillo de pimienta
moulin à poivre



Mahlwerk aus Carbonstahl, Mahlgrad stufenlos einstellbar

mill in carbon steel, the grinding degree can be adjusted infinitely

molinillo de acero al carbono, el grado de molino se puede ajustar de modo continuo

moulin en acier de carbone, la finesse de mouture se peut régler de façon continue

	Ø cm	↑ cm
40555	6	15,5



Salzmühle „GUNMETAL“

salt mill
molinillo de sal
moulin à sel



Mahlwerk aus Edelstahl, Mahlgrad stufenlos einstellbar

mill in stainless steel, the grinding degree can be adjusted infinitely

molinillo de acero inoxidable, el grado de molino se puede ajustar de modo continuo

moulin en acier inox, la finesse de mouture se peut régler de façon continue

	Ø cm	↑ cm
40556	6	15,5



**Pfeffermühle „ELEMENT“**

pepper mill
molinillo de pimienta
moulin à poivre

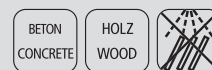

Mahlwerk aus Carbonstahl, Mahlgrad stufenlos einstellbar

mill in carbon steel, the grinding degree can be adjusted infinitely
molinillo de acero al carbono, el grado de molino se puede ajustar de modo continuo
moulin en acier de carbone, la finesse de mouture se peut réglée de façon continue

	Ø cm	↑ cm
40557	7,5	15,5

**Salzmühle „ELEMENT“**

salt mill
molinillo de sal
moulin à sel

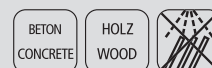

Mahlwerk aus Edelstahl, Mahlgrad stufenlos einstellbar

mill in stainless steel, the grinding degree can be adjusted infinitely
molinillo de acero inoxidable, el grado de molino se puede ajustar de modo continuo
moulin en acier inox, la finesse de mouture se peut réglée de façon continue

	Ø cm	↑ cm
40558	7,5	15,5

**Pfeffermühle „ELEMENT“**

pepper mill
molinillo de pimienta
moulin à poivre

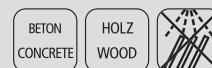

Mahlwerk aus Carbonstahl, Mahlgrad stufenlos einstellbar

mill in carbon steel, the grinding degree can be adjusted infinitely
molinillo de acero al carbono, el grado de molino se puede ajustar de modo continuo
moulin en acier de carbone, la finesse de mouture se peut réglée de façon continue

	Ø cm	↑ cm
40538	6	18

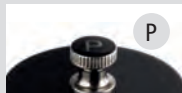
**Salzmühle „ELEMENT“**

salt mill
molinillo de sal
moulin á sel

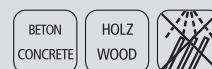

Mahlwerk aus Edelstahl, Mahlgrad stufenlos einstellbar

mill in stainless steel, the grinding degree can be adjusted infinitely
molinillo de acero inoxidable, el grado de molino se puede ajustar de modo continuo
moulin en acier inox, la finesse de mouture se peut réglée de façon continue

	Ø cm	↑ cm
40539	6	18



PEPPER, - SALT MILL



Pfeffer- u. Salzmühle „PROFESSIONAL“

salt / pepper mill
molinillo de sal / pimienta
moulin à sel / poivre



Mahlgrad stufenlos einstellbar

the grinding degree can be adjusted infinitely
el grado de molino se puede ajustar de modo continuo
la finesse de mouture se peut réglée de façon continue

	Ø cm	↑ cm	Farbe / Colour	
40540	5,5	15		pepper mill
40541	5,5	15		salt mill



Pfeffermühle „PROFESSIONAL VINTAGE“

pepper mill
molinillo de pimienta
moulin à poivre



Deutsches Buchenholz, vintage, Mahlwerk aus Carbonstahl, Mahlgrad stufenlos einstellbar

German beechwood, vintage, mill in carbon steel,
the grinding degree can be adjusted infinitely
madera de haya alemana, carácter „vintage“, molinillo de acero
al carbono, el grado de molino se puede ajustar de modo continuo
bois de hêtre d'Allemagne, vintage, moulin en acier de carbone,
la finesse de mouture se peut réglée de façon continue

	Ø cm	↑ cm	Farbe / Colour
40535	5,5	15	
40537	6,0	23	
40546	5,5	15	
40548	6,0	23	



Pfeffermühle

pepper mill
molinillo de pimienta
moulin à poivre



Mahlwerk aus Carbonstahl, Mahlgrad stufenlos einstellbar

mill in carbon steel, the grinding degree can be adjusted infinitely
molinillo de acero al carbono, el grado de molino se puede ajustar de modo continuo
moulin en acier de carbone, la finesse de mouture se peut réglée de façon continue

	Ø cm	↑ cm	Farbe / Colour
40559	5,5	18	



Salzmühle

salt mill
molinillo de sal
moulin à sel



Mahlwerk aus Edelstahl, Mahlgrad stufenlos einstellbar

mill in stainless steel, the grinding degree can be adjusted infinitely
molinillo de acero inoxidable, el grado de molino se puede ajustar de modo continuo
moulin en acier inox, la finesse de mouture se peut réglée de façon continue

	Ø cm	↑ cm	Farbe / Colour
40560	5,5	18	



Salzmühle „PROFESSIONAL VINTAGE“

salt mill
molinillo de sal
moulin à sel



Deutsches Buchenholz, vintage, Mahlwerk aus Edelstahl, Mahlgrad stufenlos einstellbar

German beechwood, vintage, mill in stainless steel, the grinding degree can be adjusted infinitely
madera de haya alemana, carácter „vintage“, molinillo de acero inoxidable, el grado de molino se puede ajustar de modo continuo
bois de hêtre d'Allemagne, vintage, moulin en acier inox, la finesse de mouture se peut régler de façon continue

	Ø cm	↑ cm	Farbe / Colour
40536	5,5	15	
40547	5,5	15	



Pfeffermühle „PROFESSIONAL“

pepper mill
molinillo de pimienta
moulin à poivre



Mahlwerk aus Carbonstahl, Mahlgrad stufenlos einstellbar

mill in carbon steel, the grinding degree can be adjusted infinitely
molinillo de acero al carbono, el grado de molino se puede ajustar de modo continuo
moulin en acier de carbone, la finesse de mouture se peut réglée de façon continue

	Ø cm	↑ cm	Farbe / Colour
40530	5,5	15	Holz / wood
40532	7,0	30	Holz / wood
40534	7,0	40	Holz / wood



Mahlgrad einstellbar
grinder setting

	Ø cm	↑ cm	Farbe / Colour
40520	5,5	15	Holz / wood
40522	7,0	30	Holz / wood
40524	7,0	40	Holz / wood



Mahlgrad einstellbar
grinder setting



Salzmühle „PROFESSIONAL“

salt mill
molinillo de sal
moulin à sel



Mahlwerk aus Edelstahl, Mahlgrad stufenlos einstellbar

mill in stainless steel, the grinding degree can be adjusted infinitely
molinillo de acero inoxidable, el grado de molino se puede ajustar de modo continuo
moulin en acier inox, la finesse de mouture se peut réglée de façon continue

	Ø cm	↑ cm	Farbe / Colour
40531	5,5	15	Holz / wood
40521	5,5	15	Holz / wood

PEPPER, - SALT MILL



Tablett

tray
bandeja
plateau

mit 2 Absätzen Ø 6 cm
with 2 holes Ø 6 cm
con 2 agujeros Ø 6 cm
avec 2 trous Ø 6 cm



	cm	↑ cm
84039	16,5 x 8,5	1,5



Naturschieferplatte / Untersetzer

natural slate tray
bandeja de pizarra natural
plateau ardoise naturelle

mit 2 Absätzen Ø 6 cm
with 2 holes Ø 6 cm
con 2 agujeros Ø 6 cm
avec 2 trous Ø 6 cm



	cm	✂ mm
00971	15 x 8	6 - 9



2 in 1 Salz- u. Pfeffermühle

2 in 1 salt / pepper mill
2 in 1 molinillo de sal / pimienta
2 in 1 moulin à sel / poivre

Keramik Mahlwerk
ceramic mechanism
molinillo de cerámica
broyeur en céramique



	Ø cm	↑ cm
40545	7,5	18,5



Mahlgrad einstellbar
grinder setting

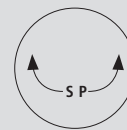

2 in 1 Salz- u. Pfeffermühle

2 in 1 salt / pepper mill
2 in 1 molinillo de sal / pimienta
2 in 1 moulin à poivre / sel

Keramik Mahlwerk
ceramic mechanism
molinillo de cerámica
broyeur en céramique



	cm	↑ cm
40544	6 x 4,5	9,5



Mahlgrad einstellbar
grinder setting

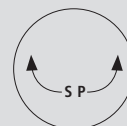



Löcher
Ø 5 mm
inkl.
Staubdeckel

Käse- oder Gewürzstreuer

spice shaker
botes especieros
saupoudreuse à épices



	Ø cm	↑ cm	litr.
00775	5,5	7,5	0,15



inkl.
Staubdeckel

Netzstreuer

mesh top shaker
polvoreador, tapa con malla fina
pot à épices, couvercle toile fine



	Ø cm	↑ cm	litr.
00776	5,5	7,5	0,15



Löcher Ø 1 mm
inkl. Staubdeckel

Streuer fein

small hole shaker
polvoreador, tapa con agujeros pequeños
pot à épices, couvercle à petits trous



	Ø cm	↑ cm	litr.
00777	5,5	7,5	0,15



Löcher
Ø 2,5 mm
inkl.
Staubdeckel

Streuer grob

large hole shaker
polvoreador, tapa con agujeros grandes
pot à épices, couvercle à grands trous



	Ø cm	↑ cm	litr.
00778	5,5	7,5	0,15



00773

00774



00781



00782



00783

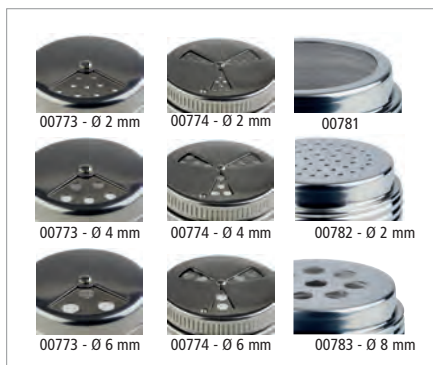

00773 - Ø 2 mm

00774 - Ø 2 mm

00781

00773 - Ø 4 mm

00774 - Ø 4 mm

00782 - Ø 2 mm

00773 - Ø 6 mm

00774 - Ø 6 mm

00783 - Ø 8 mm

Multistreuer

multi-functional shaker
salero
saupoudreuse



	Ø cm	↑ cm	litr.
00773	6	8	0,05
00774	7	12	0,20
00781	6,5	12	0,20
00782	6,5	12	0,20
00783	6,5	12	0,20

PEPPER, - SALT SHAKER



40500 - 2er Set
1 Salz- und
1 Pfefferstreuer

40501 - 2er Set
1 Salz- und
1 Pfefferstreuer

40507 - 2er Set
1 Salz- und 1 Pfefferstreuer

Salz- und Pfefferstreuer, 2er Set

salt - and pepper shaker, 2 pcs.
piezas de sal y pimienta, set de 2
sel et poivre, set de 2



	Ø cm	↑ cm	pcs.	
40500	5	6,5	2	glatte Ausführung / smooth version versión recta / forme lisse
40501	5	6,5	2	geriffelte Ausführung / fluted version versión ondulada / forme ondulée
40507	6	10,0	2	



40504
12er Set

40505
12er Set

Allzweckstreuer, 12er Set

shaker, 12 pcs.
dosificador, set de 12
salières/poivrières, set de 12



	cm	↑ cm	pcs.	
40504	4 x 4	10	12	13 Löcher / 13 holes 13 agujeros / 13 trous
40505	4 x 4	10	12	3 Löcher / 3 holes 3 agujeros / 3 trous



40504

40505



Ministreuer, 4er Set

smaller shaker, 4 pcs.
bodegas pequeñas, set de 4
mini-salières, set de 4



	Ø cm	↑ cm	pcs.
40503	3,5	4	4



00779

00772

Salzstreuer

salt shaker
salero
salière



Pommes-Frites Streuer mit Schraubkappe

for french fries, cover to screw
para patatas fritas, tapa de rosca
pour les frites, couvercle à visser

	Ø cm	↑ cm	
00779	8	17	Aluminium / aluminium aluminio / aluminium
00772	8	17	Edelstahl / stainless steel acero inoxidable / inox



Pfeffer- & Salz-Menage „WOOD“

salt- and pepper-menage
salero-pimentero
ménage sel et poivre



matt poliert, Glasbehälter mit Edelstahl-Deckel und Deckelverschluss
satin polished finish, glass with stainless steel cover
pulido acabado efecto satinado, cristal con tapa de acero inoxidable
verre et inox mat satiné

	cm	↑ cm
40435	11,5 x 5,5	17



Essig- & Öl-Menage „WOOD“

oil- and vinegar-menage
aceitera-vinagrera
ménage huile et vinaigre



matt poliert, Glasbehälter mit Edelstahl-Deckel und Deckelverschluss
satin polished finish, glass with stainless steel cover
pulido acabado efecto satinado, cristal con tapa de acero inoxidable
verre et inox mat satiné

	cm	↑ cm
40436	16 x 7,5	24,5



Pfeffer-, Salz-, Essig- und Öl-Menage „WOOD“

salt- and pepper- and oil- and vinegar-menage
salero-pimentero & aceitera-vinagrera
ménage sel et poivre & huile et vinaigre



matt poliert, mit möbelschonender Unterseite
satin polished finish, glass with stainless steel cover
pulido acabado efecto satinado, con tapa de acero inoxidable
verre et inox mat satiné, avec couvercle inox

	cm	↑ cm
40437	15,5 x 12	24,5

Salz- und Pfefferstreuer / salt - and pepper shaker / juego de sal y pimienta / set sel et poivre

	Ø cm	↑ cm	
40438	4	9	6 Löcher - Ø 1,85 mm
40439	4	9	18 Löcher - Ø 1,35 mm

Ersatzglas Essig / Öl / spare glass vinegar / oil / cristal de recambio con tapa „aceite & vinagre“
verre huile ou vinagre

	Ø cm	↑ cm	ltr.
40442	6	18,5	0,2



mit praktischem Ausgießer
with no drips pourer



Pfeffer- und Salz-Menage „ELEMENT“

salt- and pepper-menage
salero-pimentero
ménage sel et poivre



Beton-Ständer, Glasbehälter mit Edelstahl-Deckel, mit möbelschonender Unterseite
stand made of concrete, glass with stainless steel cover, furniture-friendly underside

soporte de hormigón, recipiente de vidrio con tapa de acero inoxidable, con base anti rayaduras
support en béton, récipient en verre avec couvercle en acier inox, avec revêtement antirayures

	cm	↑ cm
40410	10 x 6	17



Essig- und Öl-Menage „ELEMENT“

oil- and vinegar-menage
aceitera-vinagrera
ménage huile et vinaigre



Beton-Ständer, Glasbehälter mit Edelstahl-Deckel und tropffreiem Kunststoff-Ausgießer, mit möbelschonender Unterseite
stand made of concrete, glass with stainless steel cover and non-drip nozzle-spout, furniture-friendly underside

soporte de hormigón, recipiente de vidrio con tapa de acero inoxidable y sistema antigoteo, con base anti rayaduras
support en béton, récipient en verre avec couvercle en acier inox et verseur antigoutte, avec revêtement antirayures

	cm	↑ cm
40411	14 x 8	25



Pfeffer-, Salz-, Essig- und Öl-Menage „ELEMENT“

salt- and pepper- and oil- and vinegar-menage
salero-pimentero & aceitera-vinagrera
ménage sel et poivre & huile et vinaigre



Beton-Ständer, Glasbehälter mit Edelstahl-Deckel und Drehverschluss, mit möbelschonender Unterseite
stand made of concrete, glass with stainless steel cover and screw cap, furniture-friendly underside

soporte de hormigón, recipiente de vidrio con tapa de acero inoxidable y tapón de rosca, con base anti rayaduras
support en béton, récipient en verre avec couvercle en acier inox et bouchon à vis, avec revêtement antirayures

	cm	↑ cm
40412	12,5 x 12,5	25



Pfeffer-, Salz-, Essig- und Öl-Menage „ELEMENT“

salt- and pepper- and oil- and vinegar-menage
salero-pimentero & aceitera-vinagrera
ménage sel et poivre & huile et vinaigre

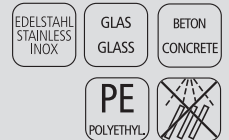

Beton-Ständer mit Kartenhalterung, Glasbehälter mit Edelstahl-Deckel und Drehverschluss, mit möbelschonender Unterseite
stand made of concrete with card holder, glass with stainless steel cover and screw cap, furniture-friendly underside

soporte de hormigón con tarjetero, recipiente de vidrio con tapa de acero inoxidable y tapón de rosca, con base anti rayaduras
support en béton avec porte-cartes, récipient en verre avec couvercle en acier inox et bouchon à vis, avec revêtement antirayures

	cm	↑ cm
40413	14 x 13,5	20



mit Kartenhalterung an der Rückseite
with card holder at the back



Pfeffer- & Salz-Menage „CLASSIC“

salt- and pepper-menage
salero-pimentero
ménage sel et poivre



Glasbehälter mit Edelstahl-Deckel und Drehverschluss

glass with stainless steel cover
vidrio con tapa de acero inoxidable con rosca
en verre avec couvercle inox à visser

	cm	↑ cm
40310	10,5 x 6,5	16



Pfeffer- & Salz-Menage „CLASSIC“

salt- and pepper-menage
salero-pimentero
ménage sel et poivre



Glasbehälter mit Edelstahl-Deckel und Drehverschluss

glass with stainless steel cover
vidrio con tapa de acero inoxidable con rosca
en verre avec couvercle inox à visser

	Ø cm	↑ cm
40320	10,5	16



Menage „CLASSIC“

menage
menage
ménage



Glasbehälter mit Edelstahl-Deckel und tropffreiem Kunststoff-Ausgießer

with stainless steel cover and non-drip nozzle-spout
vidrio con tapa inox y sistema antigoteo
verre avec couvercle inox et verseur antigoutte

	cm	↑ cm	ltr.
40440	14,5 x 8,5	23	0,2
40450	17,5 x 10,5	23	

Ersatzglas mit Deckel / spare glass with cover / vidrio con tapa / verre + couvercle

	Ø cm	↑ cm	
40312	4	9	18 Löcher - Ø 1,35 mm
40311	4	9	6 Löcher - Ø 1,85 mm

Ersatzglas mit Deckel „Essig & Öl“ / spare glass with cover „vinegar & oil“ / cristal de recambio con tapa „vinegar & oil“ / verre huile ou vinaige avec couvercle inox et verseur antigoutte

	Ø cm	↑ cm	ltr.
40441	6	18,5	0,2

Ersatzglas mit Deckel „Zahnstocher“ / spare glass with cover „toothpick“ / porta-palillos vidrio con tapa / verre à cure-dents + couvercle

	Ø cm	↑ cm
40313	4	9



Senftöpfchen, 2er Set

mustard glass, 2 pcs. set
piezas vasos mostaza, set de 2
verres à moutarde, set de 2



inkl. Löffel und Edelstahl-Deckel

incl. spoons and covers
incluye cucharas y tapas
cuillères et couvercles inclus

	Ø cm	↑ cm	pcs.
40415	5	6	2



Menage „ECONOMIC“

menage
menage
ménage



Glasbehälter mit Edelstahl-Deckel und Drehverschluss

glass with stainless steel cover
cristal con tapa inox a rosca
en verre avec couvercle inox à visser

	cm	↑ cm
40455	8 x 4	13



Menage „ECONOMIC“

menage
menage
ménage



Glasbehälter mit Edelstahl-Deckel und Drehverschluss

glass with stainless steel cover
cristal con tapa inox a rosca
en verre avec couvercle inox à visser

	cm	↑ cm
40457	8 x 8	12

Glas für Senf / glass for mustard / vaso de cristal para mostaza / pot verre seul pour la moutarde

40464



40458

Menage „ECONOMIC“

menage
menage
ménage



Glasbehälter mit Edelstahl-Deckel und tropffreiem Kunststoff-Ausgießer

glasses with stainless steel cover and non-drip nozzle-spout
cristales con tapa de acero inoxidable y sistema antigoteo
en verre avec couvercle inox et insert plastique antigoutte

	cm	↑ cm
40458	11,5 x 5,5	22
40460	11,0 x 10,5	22

Pfeffer- oder Salz-Glasstreuer / pepper- or salt-glass with cover salero o pimentero de cristal con tapa / salière ou poivrière seule en verre avec couvercle inox

	Ø cm	↑ cm
40461	3	9

Essig- oder Öl-Glasbehälter / oil- or vinegar-glass with cover / aceitera-vinagrera con tapa bouteille huile ou vinaigre seule en verre et couv. inox

	Ø cm	↑ cm
40462	4,5	16

Glas für Zahnstocher / glass for tooth picks / vaso de cristal para palillos de dientes porte-cure-dents env erre

	Ø cm	↑ cm
40463	3	6



40460



Menage „PRO“

menage
menage
ménage



matt poliert, Glasbehälter mit Edelstahl-Deckel und tropffreiem Kunststoff-Ausgießer

satin polished finish, glass with stainless steel cover and non-drip nozzle-spout

inox satinado, vidrio, sistema antigoteo

inox poli mat satiné et verre, insert plastique antigoutte

	cm	↑ cm
40476	12,0 x 8,0	19
40478	12,5 x 11,0	19
40480	13,0 x 11,0	19

Pfeffer- oder Salz-Glasstreuer / pepper- or salt-glass with cover / salero o pimentero de cristal con tapa
salière ou poivrière seule en verre avec couvercle inox

	Ø cm	↑ cm
40461	3	9

Essig- oder Öl-Glasbehälter / oil- or vinegar-glass with cover / aceitera-vinagrera con tapa
bouteille huile ou vinaigre seule en verre et couv. inox

	Ø cm	↑ cm
40462	4,5	16



Menage „PRO“

menage
menage
ménage



matt poliert, Glasbehälter mit Edelstahl-Deckel und Drehverschluss

satin polished finish, glass with stainless steel cover

inox satinado, vidrio y tapas con rosca

inox poli mat satiné et verre, couvercle à visser

	cm	↑ cm
40470	8,5 x 5,7	11,5
40472	9,2 x 8,5	11,5
40474	10,0 x 10,0	11,5



Parmesan-Menage „CLASSIC“

cheese dish
quesera parmesano
service à parmesan

hochglanzpoliert, inkl. Löffel
mirror polished finish, with spoon
pulido efecto espejo, con bol cristal y cuchara
brillant, avec bol verre et cuillère



	Ø cm	↑ cm
40330	10,5	7

Ersatzbehälter / sparecontainer / bol de recambio / bol de rechange

	Ø cm
40331	10,5



Parmesan-Menage „PROFI“

cheese dish
quesera parmesano
service à parmesan



	Ø cm	↑ cm
40424	9	5,5

Ersatzbehälter / sparecontainer / bol de recambio / bol de rechange

	Ø cm
40331	10,5



Parmesan-Menage „PRO“

cheese dish
quesera parmesano
service à parmesan

matt poliert, inkl. Löffel
satin polished finish, with spoon
pulido mate satinado, con bol cristal y cuchara
mat satiné, avec bol verre et cuillère



	Ø cm	↑ cm
40482	10,5	13

Ersatzbehälter / sparecontainer / bol de recambio / bol de rechange

	Ø cm
40331	10,5



Parmesan-Menage „ECONOMIC“

cheese dish
quesera parmesano
service à parmesan

inkl. Kunststofflöffel
with spoon
con cuchara
avec cuillère



	Ø cm	↑ cm
40453	10,5	7

Ersatzbehälter / sparecontainer / bol de recambio / bol de rechange

	Ø cm
40454	10,5



Essig- & Öl-Menage
oil- and vinegar-menage
aceitera-vinagrera
ménage huile et vinaigre



Glasbehälter mit Deckel und tropffreiem PE-Ausgießer
glass with lid and non-drip nozzle-spout
recipiente de cristal con tapa y sistema antigoteo
pot en verre avec couvercle et système plastique antigoutte

	cm	↑ cm	ltr.
40445	10,5 x 5,5	24	0,12
40446	13,0 x 7,0	34	0,50



tropffreier Ausgießer
non-drip spout



Gewürzständer
condiment stand
soporte salsas y condimentos
porte condiments et sauces



matt poliert, Lieferung ohne Deko
satin polished finish
acabado pulido efecto satinado
poli mat satiné

	Ø cm	↑ cm
40300	19	20



Menage
menage
menage
ménage



drehbares Gestell, Glasbehälter mit Edelstahl-Deckel und Drehverschluss
rotating stand, glass with stainless steel cover
soporte giratorio con piezas de vidrio y tapas inox
tournant, avec pièces en verre et couvercle inox

	Ø cm	↑ cm
40485	16	20



Ständer „URBAN“

serving stand
soporte 2 botellas
support 2 bouteilles

Metall schwarz, mit Kartenhalterung
metal black, with card holder
metal negro, con tarjetero
métal noir, avec porte-cartes



	cm	↑ cm
40414	13 x 8,5	25



mit Kartenhalterung an der Rückseite
with card holder at the back



350 ml

Essig- & Öl-Flasche „OLD FASHIONED“

oil- and vinegar bottle
botella de aceite y vinagre
bouteille d'huile et vinaigre

Glasflasche, Edelstahl - Ausgießer mit Deckel
glass bottle, stainless steel spout with lid
botella de vidrio, pico verteder de acero inoxidable con tapa
bouteille en verre, bec verseur en acier inox avec couvercle



	Ø cm	↑ cm	ltr.
40511	7	22	0,35



93308
200 ml

93309

Spritzflasche inklusive Ausgießer

squeeze bottle with nozzle
botella exprimible con dosificador
flacon pulvérisateur avec bec verseur

ideal für Bitter-Liköre, Essig, Öl
perfect for bitter liqueur, vinegar, oil
perfecto para licores amargos, vinagre, aceite
idéal pour liqueur amère, vinaigre, huile



	cm	↑ cm	ltr.
93308	6 x 5	20	0,2

Ausgießer passend für Spritzflasche / nozzle suitable for squeeze bottle / dosificador apto para botella exprimible / bec verseur approprié pour flacon pulvérisateur

	Ø cm	↑ cm
93309	2,5	5,5



350 ml

Zuckerdosierer „OLD FASHIONED“

sugar dispenser
azucarero
sucrier



Schraubdeckel aus Edelstahl, mit Dosierklappe
cover stainless steel with dosing flap
tapa de acero inoxidable, con cierre dosificador
couvrecl en acier inox, avec couvercle de dosage

	Ø cm	↑ cm	ltr.
40510	7,5	14	0,35



mit Dosierklappe
with dosing flap



300 ml

Zuckerdosierer

sugar dispenser
azucarero
sucrier



Schraubdeckel aus Edelstahl
cover stainless steel
tapa de acero inoxidable
couvrecl en acier inox

	Ø cm	↑ cm	ltr.
00766	8,5	15	0,3

Ersatzglasbehälter / spare glass-container / contenedor de repuesto / récipient verre de rechange

00768



40490
150 ml

40494
250 ml

Zuckerdosierer

sugar dispenser
azucarero
sucrier



Schraubdeckel aus Edelstahl, mit Dosierrohr
cover stainless steel with dosingtube
tapa de acero inoxidable y tubo dosificador
couvrecl en acier inox et tube doseur

	Ø cm	↑ cm	ltr.
40490	8,5	12	0,15
40494	8,5	15	0,25

Ersatzglasbehälter / spare glass-container / contenedor de repuesto / récipient verre de rechange

fits to

40498	40490
40499	40494

SUGAR DISPENSER



200 ml

Zuckerdosierer

sugar dispenser
azucarero
sucrier



Schraubdeckel aus Edelstahl mattiert, mit Dosierrohr
cover stainless steel matt polished, with dosing tube
tapa de rosca de acero inoxidable mate y tubo dosificador
couvercle à vis en acier inox mat et tube doseur

	Ø cm	↑ cm	ltr.
40509	6	14,5	0,20



40486 250 ml

40506 320 ml

Zuckerdosierer

sugar dispenser
azucarero
sucrier



Schraubdeckel aus Edelstahl, mit Dosierrohr
cover stainless steel, with dosing tube
tapa de acero inoxidable y tubo dosificador
couvercle en acier inox et tube doseur

	Ø cm	↑ cm	ltr.
40486	8,0	15	0,25
40506	7,5	17	0,32



250 ml

Allzweckgießer

pourer
dosificador
doseur



Schraubdeckel aus Edelstahl und Kunststoff, mit Dosierklappe
cover stainless steel and plastic, with dosing flap
tapa de acero inoxidable y plástico, con cierre dosificador
couvercle en acier inox et plastique, avec couvercle de dosage

	Ø cm	↑ cm	ltr.
40488	8	12,5	0,25



300 ml

Allzweckgießer

pourer
bote vertedor universal
pot verseur universel



für Honig, Kaffeesahne, etc., Schraubdeckel aus Edelstahl
for honey, cream, etc., cover stainless steel
para miel, crema, etc., tapa de acero inoxidable
pour le miel, le lait, la crème, etc., couvercle en acier inox

	Ø cm	↑ cm	ltr.
00765	8,5	13,5	0,3

Ersatzglasbehälter / spare glass-container / contenedor de repuesto / récipient verre de rechange

00768



320 ml

Zuckerdosierersugar dispenser
azucarero
sucrier**Schraubdeckel mit Klappe aus Edelstahl, mit Dosierklappe**cover stainless steel, with dosing flap
tapa acero inoxidable, con cierre dosificador
couvercle inox, avec couvercle doseur

	Ø cm	↑ cm	ltr.
40487	7,5	13,5	0,32



200 ml

Zuckerdosierersugar dispenser
azucarero
sucrier**mit Schraubverschluss, Dosier-Rohr Ø 15 mm**cover and dosingtube Ø 15 mm
con tapa y tubo dosificador Ø 15 mm
couvercle avec tube doseur Ø 15 mm

	Ø cm	↑ cm	ltr.
40508	6,5	14,5	0,20



170 ml

Zuckerspendersugar pourer / milk jug
dispensador de azúcar
sucrier doseur**matt poliert**satin polished finish
pulido efecto satinado
intérieur et extérieur poli mat

	Ø cm	↑ cm	ltr.
10316	5	15	0,17

**Zuckerkugel**sugar pot
azucarero
sucrier**hochglanzpoliert, mit Rolldecke**mirror polished finish, rolltop cover
pulido acabado brillante, tapa abatible
brillant, couvercle abattant

	Ø cm	↑ cm
00033	13,5	15

BUTTER DISH · EGG HOLDER



Butterservierer
butter dish
mantequillera
beurrer



	cm	↑ cm	ltr.
15925	Ø 9	9	0,07
15926	9 x 9	9	0,075



Butterservierer
butter dish
mantequillera
beurrer



hochglanzpoliert
mirror polished finish
acabado brillante
poli brillant

	Ø cm	↑ cm	ltr.
15921	9	7	0,06



Schale „ENAMELWARE“
bowl
cuenco
bol



	cm	↑ cm	ltr.
40667	16 x 12,0	3,5	0,20
40668	18 x 13,5	4,0	0,35



Kühlschrank-Butterdose
refrigerator butter dish
mantequillera para nevera
boîte à beurre pour le frigo



	cm	↑ cm
00063	16 x 9,5	5,5



Eierbecher
egg holder
huevera
coquetier



	Ø cm	↑ cm
00032	8,5	2



NEW

2,2 ltr.

65060

Fondue und Feuerzangenbowle-Set „TWO IN ONE“

fondue and fire punch bowl set
set para fondue o ponche caliente
service à fondue et à punch

EDELSTAHL
STAINLESS
INOX
18/8

PP
POLYPROP.

13-teiliges Set aus Edelstahl bestehend aus:

1 Topf, 1 Rechaud, 1 Spritzschutz, 1 Untersetzer, 1 Schöpfkelle, 1 Feuerzange,
1 Pastenbrenner, 6 Fonduegabeln

13-piece stainless steel set consisting of:

1 pot, 1 rechaud, 1 splash guard, 1 coaster, 1 ladle, 1 fire tongs,
1 paste burner, 6 fondue forks

set de 13 piezas de acero inoxidable compuesto por:

1 olla, 1 rechaud, 1 protector contra salpicaduras, 1 trébede, 1 cazo,
1 pinza para el fuego, 1 quemador de pasta, 6 tenedores de fondue

set de 13 pièces en acier inox comprenant:

1 marmite, 1 rechaud, 1 pare-éclaboussures, 1 dessous de plat, 1 louche, 1 pince à feu,
1 brûleur à pâte, 6 fourchettes à fondue

	Ø cm	↑ cm	ltr.
65060	22	23	2,2



Kaviarkühler

caviar cooler
enfriador de caviar
rafraîchisseur de caviar

GLAS
GLASS

EDELSTAHL
STAINLESS
INOX
18/8

GLAS
GLASS

EDELSTAHL
STAINLESS
INOX
18/8

4-teilig: Glasschale Ø 10 cm / 4 pcs.: glass bowl Ø 10 cm / set de 4: bol Ø 10 cm
set de 4: bol Ø 10 cm

	Ø cm	↑ cm
01699	18	12



Butter- und Saucenwärmer

butter and sauce pan warmer
calentador de mantequilla y salsa
réchaud à beurre et sauce

EDELSTAHL
STAINLESS
INOX
18/8

EDELSTAHL
STAINLESS
INOX
18/8

Saucentopf mit Ausgießer + Deckel + Gestell (passend für 1 Teelicht)

pan with spout + lid + riser (for 1 light)

cacerola + tapadera + soporte (para 1 vela)

petite casserole avec bec verseur + couvercle + support (pour 1 bougie)

	Ø cm	↑ cm	ltr.	Griff / handle cm
35350	14	16	0,7	13,5



75001
Spießständer
skewer rack

75002
Spieße
skewer

Spießständer / Spieße

espetada and kebab skewer rack / skewer
soporte para brochetas
support pour brochettes

METALL
VERCHROMT

EDELSTAHL
STAINLESS
INOX

zum Servieren von Fleischspießen bis 40 cm, Gestell aus 8 mm Edelstahl

to serve skewers up to 40 cm, wire stainless steel 8 mm

para servir brochetas de carne hasta 40 cm, grosor del alambre 8 mm, inox

pour présenter les brochettes long. maxi 40 cm, fil 8 mm, inox

	Ø cm	↑ cm	
75001	22,0	46	
75002	0,3	40	4er Set / 4 pcs. set



VINTAGE

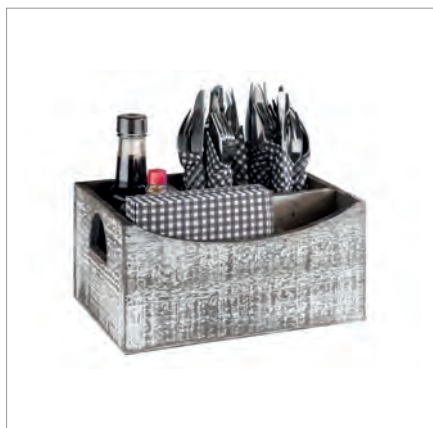

Table Caddy „VINTAGE“

table caddy
caddy de mesa
caddy de table



unterteilt in 5 Fächer
divided into 5 compartments
dividido en 5 compartimentos
divisé en 5 compartiments

	cm	↑ cm
11608	22 x 15,5	11,5



Table Caddy „VINTAGE“

table caddy
caddy de mesa
caddy de table



unterteilt in 7 Fächer
divided into 7 compartments
dividido en 7 compartimentos
divisé en 7 compartiments

	cm	↑ cm
11609	25,5 x 15,5	11,5



Table Caddy „VINTAGE“

table caddy
caddy de mesa
caddy de table



unterteilt in 4 Fächer, mit Tragegriff
divided into 4 compartments, with handle
dividido en 4 compartimentos, con asa
divisé en 4 compartiments, avec poignée

	cm	↑ cm
11610	22 x 15,5	22



Table Caddy „VINTAGE“

table caddy
caddy de mesa
caddy de table



	cm	↑ cm
11612	15 x 15	10



Table Caddy „VINTAGE“

table caddy
caddy de mesa
caddy de table



herausnehmbare Aufteilung, 6 Fächer (7,5 x 7,5 cm)
separation removable, 6 compartments (7,5 x 7,5 cm)
separadores amovibles, 6 compartimentos (7,5 x 7,5 cm)
séparateurs amovibles, 6 compartiments (7,5 x 7,5 cm)

	cm	↑ cm
11638	27 x 17	10



Table Caddy „ELEMENT“

table caddy
caddy de mesa
caddy de table



Beton, mit möbelschonender Unterseite
concrete, furniture-friendly underside
hormigón, con base anti rayaduras
béton, avec revêtement antirayures

	cm	↑ cm	inner size cm
11647	16,5 x 16	6,5	14,5 x 14



Table Caddy „ELEMENT“

table caddy
caddy de mesa
caddy de table



Beton, mit möbelschonender Unterseite, 2 Löcher je 6,5 cm
concrete, furniture-friendly underside, 2 holes each 6.5 cm
hormigón, con base anti rayaduras, 2 agujeros cada uno 6,5 cm
béton, avec revêtement antirayures, 2 trous de 6,5 cm chacun

	cm	↑ cm	inner size cm
11648	23,5 x 16	6,5	14,5 x 14

TABLE CADDY



Table Caddy „ACACIA“

table caddy
caddy de mesa
caddy de table



Akazienholz, 3-Fächer

Fach 1+3: 11,5 x 5,5 cm / Fach 2: 12,0 x 11,5 cm

acacia wood, 3 compartments

compartment 1+3: 11,5 x 5,5 cm / compartment 2: 12,0 x 11,5 cm

madera de acacia, 3 compartimentos

compartimento 1+3: 11,5 x 5,5 cm / compartimento 2: 12,0 x 11,5 cm

bois d'acacia, 3 compartiments

compartiments 1+3: 11,5 x 5,5 cm / compartiment 2: 12,0 x 11,5 cm

	cm	↑ cm
40403	27,5 x 13,5	24

passende Brottasche / suitable bread basket / panera a juego / corbeille assortie

	cm	↑ cm	Farbe / Colour
30355	12 x 11,5	11,5	
30356	12 x 11,5	11,5	



Table Caddy

table caddy
caddy de mesa
caddy de table



Akazienholz, 2-Fächer

acacia wood, 2 compartements

madera de acacia, 2 compartimentos

bois d'acacia, 2 compartiments

	cm	↑ cm	inner size cm
40405	25 x 15	18	21,5 x 8



Table Caddy „VINTAGE“

table caddy
caddy de mesa
caddy de table



Holz, 2-Fächer (13,5 x 6 cm)

2 compartments (13,5 x 6 cm)

2 compartimentos (13,5 x 6 cm)

2 compartiments (13,5 x 6 cm)

	cm	↑ cm	inner size cm
40404	15,5 x 15,5	15	13,5 x 6



Holzbox „WOODY“

woodbox
caja madera
base bois



Akazienholz, 4-Fächer

acacia wood, 4 compartements

madera de acacia, 4 compartimentos

bois d'acacia, 4 compartiments

	cm	↑ cm	inner size cm
11649	36 x 14	12,5	12,5 x 8



Holzbox „TABLE“

woodbox
caja madera
base bois



Akazienholz, 3 Fächer (6,5 x 6,5 cm)

acacia wood, 3 compartments (6,5 x 6,5 cm)
madera de acacia, 3 compartimentos (6,5 x 6,5 cm)
bois d'acacia, 3 compartiments (6,5 x 6,5 cm)

	cm	↑ cm	inner size cm
11727	23,5 x 8,5	4,5	6,5 x 6,5 je Fach / each compartment

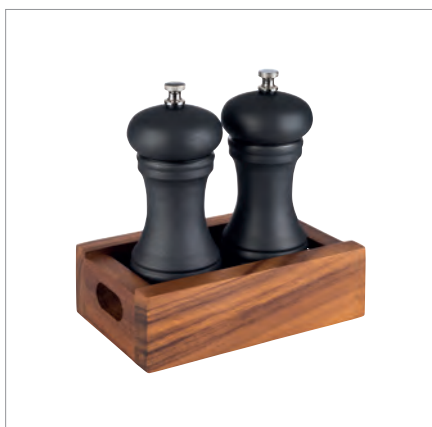

Holzbox „TABLE“

woodbox
caja madera
base bois



Akazienholz natur

acacia wood nature
madera de acacia natural
bois d'acacia naturel

	cm	↑ cm	inner size cm
11726	15,0 x 9,5	5	12 x 6,5



Table Caddy

table caddy
caddy de mesa
caddy de table



Akazienholz

acacia wood
madera de acacia
bois d'acacia

	cm	↑ cm	inner size cm
11625	23 x 10	10	22,5 x 6



Holzbox „WOODY“

woodbox
caja madera
base bois



Akazienholz

acacia wood
madera de acacia
bois d'acacia

	cm	↑ cm	inner size cm
11650	15,0 x 15	5,5	13 x 13
11651	22,5 x 15	5,5	13,5 x 13 / 6,5 x 13

CANDLE HOLDER



Kerzenleuchter

candle holder
candelabro
chandelier



hochwertige Gastro Ausführung, mit möbelschonender Unterseite

heavy quality, with non-scratching undersurface

alta calidad, con base anti raya duras

haute qualité, avec revêtement antirayures

	cm	↑ cm	
04001	27,5 x 27,5	25	5-flammig / 5-lids / 5 ramas / 5 branches
04002	27,5 x 11,0	25	3-flammig / 3-lids / 3 ramas / 3 branches
	Ø cm	↑ cm	
04003	11	22	1-flammig / 1 lid / 1 rama / 1 branche
04004	11	10	1-flammig / 1 lid / 1 rama / 1 branche



Kerzenleuchter, 2er Set

candle holder, 2 pcs.
candelabros, set de 2
chandeliers, set de 2



mit möbelschonender Unterseite

with non-scratching undersurface

con base anti rayaduras

avec revêtement antirayures

	Ø cm	↑ cm	pcs.
04008	6	7	2



Kerzenleuchter

candle holder
candelabro
chandelier



extra schwerer Fuß, verchromt, mit möbelschonender Unterseite

heavy foot, chrome plated, with non-scratching undersurface

pie pesado, asa cromado, con base anti rayaduras

pie lourd, chromé, avec revêtement antirayures

	Ø cm	↑ cm	Farbe / Colour
04020	10	11	—
04021	10	16	—

**Kerzenleuchter „CLASSIC“, 2er Set**

candle holder, 2 pcs.
candelabros, set de 2
chandeliers, set de 2



mit möbelschonender Unterseite
with non-scratching undersurface
con base anti rayaduras
avec revêtement antirayures

	Ø cm	↑ cm	pcs.
04035	10	20,5	2

**Kerzenleuchter „CLASSIC“**

candle holder
candelabro
chandelier



mit möbelschonender Unterseite
with non-scratching undersurface
con base anti rayaduras
avec revêtement antirayures

	cm	↑ cm	
04036	22 x 10	22,5	3-flammig / 3-lids / 3 ramas / 3 branches

**Kerzenleuchter „CLASSIC“**

candle holder
candelabros
chandelier



mit möbelschonender Unterseite
with non-scratching undersurface
con base anti rayaduras
avec revêtement antirayures

	cm	↑ cm	
04037	22 x 22	24	5-flammig / 5-lids / 5 ramas / 5 branches

**Kerzenleuchter „XL“**

candle holder
candelabro
grand chandelier



extra hoch und schwer, mit möbelschonender Unterseite
extra high and heavy, with non-scratching undersurface
pesado y de alta calidad, con base anti rayaduras
lourd et de haute qualité, avec revêtement antirayures

	cm	↑ cm	
04005	35 x 13	39	3-flammig / 3-lids / 3 ramas / 3 branches

**Kerzenleuchter „XL“**

candle holder
candelabro
grand chandelier



extra hoch und schwer, mit möbelschonender Unterseite
extra high and heavy, with non-scratching undersurface
pesado y de alta calidad, con base anti rayaduras
lourd et de haute qualité, avec revêtement antirayures

	cm	↑ cm	
04006	35 x 35	39	5-flammig / 5-lids / 5 ramas / 5 branches

CANDLE HOLDER



Windlichter, 2er Set

wind lights, 2 pcs.
portavelas antiviento, set de 2
porte-bougies anti-vent, set de 2



matt poliert, Gläser satiniert, mit möbelschonender Unterseite
satin polished finish, glasses satin, with non-scratching undersurface
pulido acabado efecto satinado, cristales satinados, con base anti rayaduras
inox mat satiné et verre mat, avec revêtement antirayures

	Ø cm	↑ cm	pcs.
03020	5	15	2

Ersatzglas / spare glass / cristal de recambio / verre de rechange

03025



Windlichter „ELEMENT“, 2er Set

wind lights, 2 pcs.
portavelas antiviento, set de 2
porte-bougies anti-vent, set de 2



Beton, Gläser klar, mit möbelschonender Unterseite
concrete, glass clear, with non-scratching undersurface
hormigón, vidrio transparente, con base anti rayaduras
bèton, verre transparente, avec revêtement antirayures

	Ø cm	↑ cm	pcs.
03038	6	8	2

Ersatzglas / spare glass / vidrio de recambio solo / verre de rechange transparent, seul

	Ø cm	↑ cm
03098	6	5



Windlicht „ELEMENT“

wind light
porta vela
porte-bougie



Beton, Glas klar, mit möbelschonender Unterseite
concrete, glass clear, with non-scratching undersurface
hormigón, vidrio transparente, con base anti rayaduras
bèton, verre transparente, avec revêtement antirayures

	Ø cm	↑ cm
03039	7,5	13

Ersatzglas / spare glass / vidrio de recambio solo / verre de rechange transparent, seul

	Ø cm	↑ cm
03099	7,5	9



Vase mit Glaseinsatz „ELEMENT“

flower vase with glass insert
florero con tubo de cristal
vase soliflor avec verre



Beton, Glas klar, mit möbelschonender Unterseite, inkl. 2 Ersatzgläsern
concrete, clear glass, furniture-friendly underside, incl. 2 spare glasses
hormigón, cristal incoloro, con base anti rayaduras, incl. 2 tubos de repuesto
béton, verre transparente avec revêtement antirayures y compris 2 verres de rechange

	cm	↑ cm	ml
04010	10 x 4,5	12,5	25



Ersatzglas / spare glass / tubo de recambio / verre de rechange

	Ø cm	↑ cm	ml
04011	2,5	11	25



Vase

flower vase
florero
vase soliflor



Edelstahl-Look, Zinkdruckguss, vernickelt, lackiert, anlaufgeschützt, schwere Ausführung
stainless steel look, heavy zink alloy, nickel plated, laquered
aspecto acero, acabado satinado, alta calidad
aspect inox, fini mat satiné, bonne qualité

	Ø cm	↑ cm	kg
04015	4,0	16,5	0,17
04016	4,5	20,0	0,20



Vase

flower vase
florero
vase soliflor



Edelstahl-Look, Zinkdruckguss, vernickelt, lackiert, anlaufgeschützt, schwere Ausführung
stainless steel look, heavy zink alloy, nickel plated, laquered
aspecto acero, acabado satinado, alta calidad
aspect inox, fini mat satiné, bonne qualité

	Ø cm	↑ cm	kg
04017	6,5	18	0,36



Die umgelegten und angenähten Kanten machen diese Tischsets besonders robust. Geliefert in einer 6er Einheit.

The folded and sewn edges make these table sets particularly robust. Delivered in a packing unit of 6 pieces.

Los bordes doblados y cosidos des los mantelitos los hacen especialmente resistentes. Se entregan en una unidad de embalaje de 6 piezas.

Les bords repliés et cousus rendent ces sets de table en particulièrement robustes. Livré dans un emballage de 6 pièces.



Warenträger - Tischsets

display for table sets
expositor para mantelinas de mesa
présentoir pour sets de table

12 Einschubfächer, komplett auf Rollen, 2 Feststellrollen, Lieferung demontiert

12 shelves, on rolls, 2 rolls to fix, delivery unassembled

12 niveles, 4 ruedas, desmontado (montaje fácil)

12 niveaux, 4 roues, livré démonté

	cm	↑ cm
00401	39,5 x 45	165



Tischset Feinband

placemat fine band
mantelín cinta fina
set de table, tressage fin



	cm		VE / unit
60037	45 x 33	gold / gold	6
60038	45 x 33	beige braun / beige brown	6
60040	45 x 33	blau / blue	6

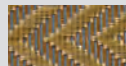

60037 - gold

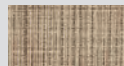

60038 - beige brown



60040 - blue



Tischset Feinband „TAO“

placemat fine band
mantelín cinta fina
set de table, tressage fin



	cm		VE / unit
60502	45 x 33	grau, beige / grey, beige	6
60503	45 x 33	beige / beige	6
60505	45 x 33	braun / brown	6



60502 - grey, beige

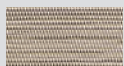

60503 - beige



60505 - brown



60044 - grey



60045 - brown

Tischset „KUNSTLEDER“

placemat
mantelín
set de table

Kunstleder
imitation leather
imitación de cuero
similicuir



	cm		VE / unit
60044	45 x 32,5	grau / grey	6
60045	45 x 32,5	braun / brown	6
60046	45 x 32,5	schwarz / black	6

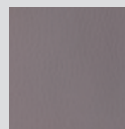

60044 - grey

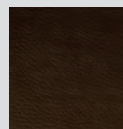

60045 - brown

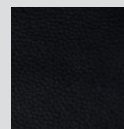

60046 - black



mit Naht rundherum

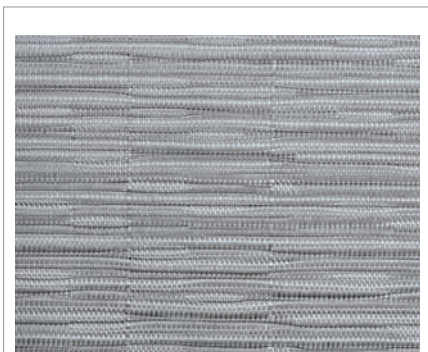

60525 - white

Tischset Schmalband

placemat smallband
mantelín cinta estrecha
set de table tressage étroit



	cm		VE / unit
60525	45 x 33	weiß / white	6
60526	45 x 33	gold / gold	6
60527	45 x 33	silber / silver	6
60528	45 x 33	grün / green	6

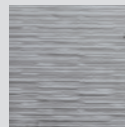

60525 - white

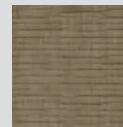

60526 - gold



60527 - silver

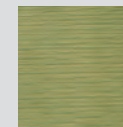

60528 - green



60535 - gold



60536 - copper

Tischset „CROCO“

placemat
mantelín
set de table

rutschhemmende Unterseite
slip resistant underside
antideslizante por debajo
dessous antiglisse



	cm		VE / unit
60535	45 x 30	gold / gold	6
60536	45 x 30	kupfer / copper	6
60537	45 x 30	braun / brown	6



60535 - gold

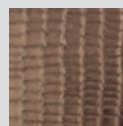

60536 - copper

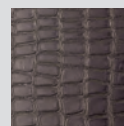

60537 - brown

TABLE SET

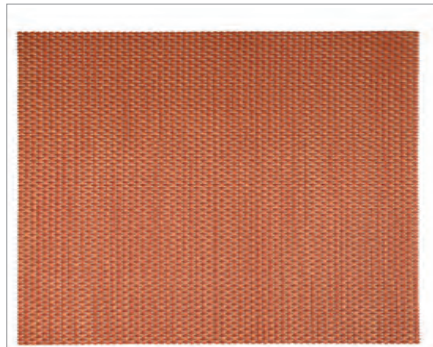

60018 - candyred

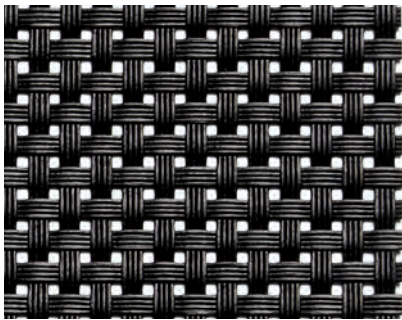

60012 - black

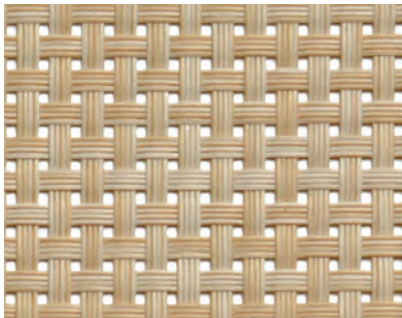

60014 - beige

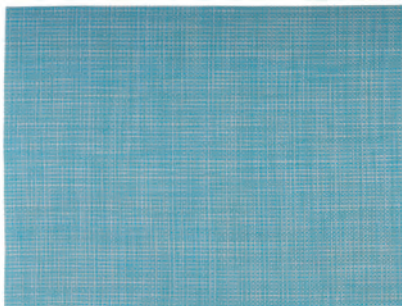

60041 - light blue, white

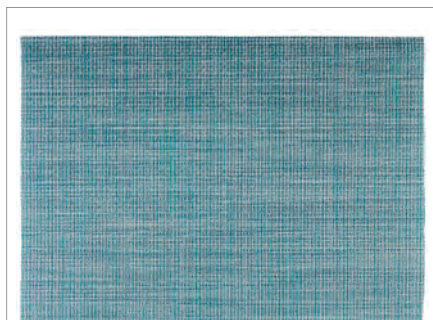

60042 - turquoise, green, white

Tischset Schmalband placemat smallband mantelín cinta estrecha set de table tressage étroit



	cm		VE / unit
60002	45 x 33	hellblau / light blue	6
60018	45 x 33	candyrot / candyred	6
60012	45 x 33	schwarz / black	6
60014	45 x 33	beige / beige	6
60015	45 x 33	silbergrau / silvergrey	6
60016	45 x 33	grün / green	6
60019	45 x 33	beige braun / beige brown	6
60522	45 x 33	hellorange / light orange	6
60520	45 x 33	schwarz weiß / black white	6
60521	45 x 33	apfelgrün / apple green	6
60523	45 x 33	violett / purple	6
60524	45 x 33	platin / platinum	6
60041	45 x 33	hellblau, weiß / light blue, white	6

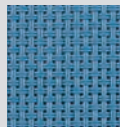

60002 - light blue



60018 - candyred

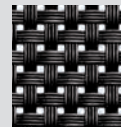

60012 - black



60014 - beige



60015 - silvergrey



60016 - green



60019 - beige brown



60522 - light orange



60520 - black white

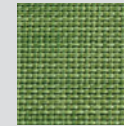

60521 - apple green

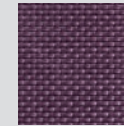

60523 - purple

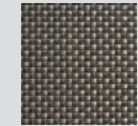

60524 - platinum

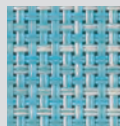

60041 - light blue, white

Tischset Feinband placemat fine band mantelín cinta fina set de table, tressage fin



	cm		VE / unit
60042	45 x 33	türkis, grün, weiß / turquoise, green, white	6
60509	45 x 33	Mosaik schwarz, grau / black, grey	6
60512	45 x 33	schwarz, grau / black, grey	6
60542	45 x 33	rot / red	6



60042 - turquoise, green, white

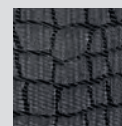

60509 - black, grey

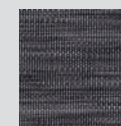

60512 - black, grey

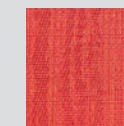

60542 - red

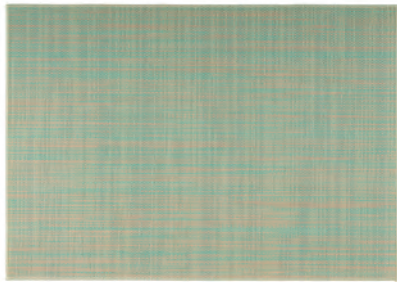

60506 - beige, turquoise

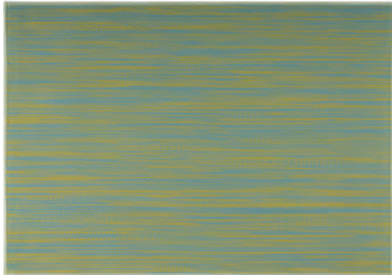

60507 - yellow, light blue



60508 - light blue, dark blue

Tischset Feinband „TAO“

placemat fine band
mantelín cinta fina
set de table, tressage fin



	cm		VE / unit
60506	45 x 33	beige, türkis / beige, turquoise	6
60507	45 x 33	gelb, hellblau / yellow, light blue	6
60508	45 x 33	hellblau, dunkelblau / light blue, dark blue	6



60506 - beige, turquoise



60507 - yellow, light blue

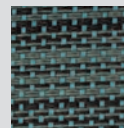

60508 - light blue, dark blue

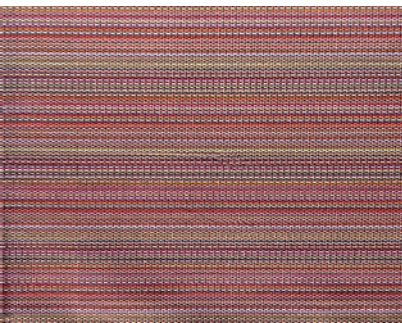

60510 - LINES orange red



60511 - LINES orange, yellow

Tischset Feinband

placemat fine band
mantelín cinta fina
set de table, tressage fin



	cm		VE / unit
60510	45 x 33	LINES orange, rot / LINES orange red	6
60511	45 x 33	LINES orange, gelb / LINES orange yellow	6
60531	45 x 33	LINES schwarz / LINES black	6
60532	45 x 33	LINES pastell / LINES pastell	6
60533	45 x 33	LINES bordeaux / LINES bordeaux	6
60534	45 x 33	LINES rot / LINES red	6
60530	45 x 33	STRIPES grau / STRIPES grey	6
60540	45 x 33	FRAMES grau / FRAMES grey	6
60541	45 x 33	FRAMES schwarz / FRAMES black	6



60510 - LINES orange red



60511 - LINES orange, yellow

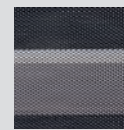

60531 - LINES black

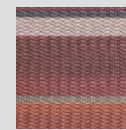

60532 - LINES pastell

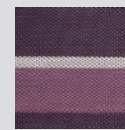

60533 - LINES bordeaux

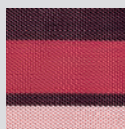

60534 - LINES red

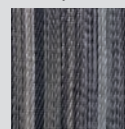

60530 - LINES grey

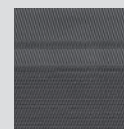

60540 - FRAMES grey

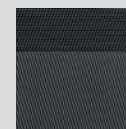

60541 - FRAMES black

TABLE SET

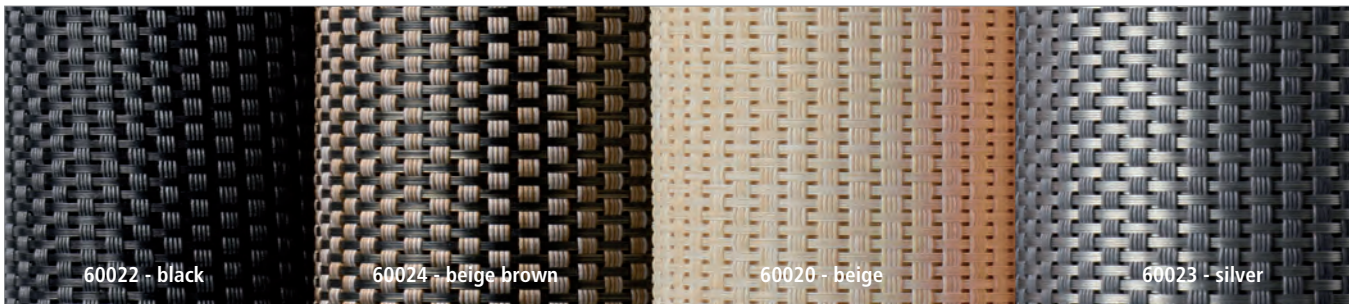

Schmalband Tischläufer

table runner fine fabric
camino de mesa
chemin de table

pflegeleichtes Kunststoffgeflecht

easy to clean

fácil de limpiar

nettoyage aisé



	cm	
60022	45 x 150	schwarz / black
60024	45 x 150	beige, braun / beige, brown
60020	45 x 150	beige / beige
60023	45 x 150	silbergrau / silver grey



60551

Servietten- und Bestecktaschen, 6er Set

cutlery bag, 6 pcs. set
bolsa cubiertos, set de 6
pochette couverts, set de 6



	cm		pcs.
60551	24 x 9	silbergrau / silvergrey	6
60550	24 x 9	beige / beige	6
60552	24 x 9	beige braun / beige brown	6
60554	24 x 9	platin / platinum	6



60550 - beige

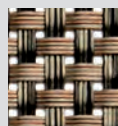

60552 - beige/braun

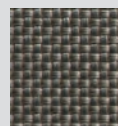

60554 - platin

ENAMELWARE



Teller „ENAMELWARE“

plate
plato
assiette



	Ø cm	↑ cm	Farbe / Colour	
40664	20	2		flacher Teller
40665	24	2		flacher Teller
40666	26	2		flacher Teller



Teller „ENAMELWARE“

plate
plato
assiette



	Ø cm	↑ cm	ltr.	Farbe / Colour	
40661	18	3,5	0,35		tiefer Teller
40662	22	3,5	0,60		tiefer Teller
40663	24	3,5	0,85		tiefer Teller



Schale „ENAMELWARE“

bowl
cuenco
bol



	cm	↑ cm	ltr.	Farbe / Colour	
40667	16 x 12,0	3,5	0,20		
40668	18 x 13,5	4,0	0,35		



Schale „ENAMELWARE“

bowl
cuenco
bol



	cm	↑ cm	ltr.	Farbe / Colour	
40669	28 x 23	4,5	1,9		

ENAMELWARE



Henkelbecher „ENAMELWARE“

beaker
vaso coctelero
bol mélangeur



	Ø cm	↑ cm	ltr.	Farbe / Colour
40636	7	5	0,10	White/Blue
40632	9	8	0,35	White/Blue
40637	10	9	0,50	White/Blue



Henkelbecher „ENAMELWARE“

beaker
vaso coctelero
bol mélangeur



	Ø cm	↑ cm	ltr.	Farbe / Colour
40633	9	8	0,35	Red/Black



Henkelbecher „ENAMELWARE“

beaker
vaso coctelero
bol mélangeur



	Ø cm	↑ cm	ltr.	Farbe / Colour
40634	9	8	0,35	Green/Black



Henkelbecher „ENAMELWARE“

beaker
vaso coctelero
bol mélangeur



	Ø cm	↑ cm	ltr.	Farbe / Colour
40635	9	8	0,35	Blue/Black



Schale „ENAMELWARE“

bowl
cuenco
bol



	Ø cm	↑ cm	ltr.	Farbe / Colour
40645	7,0	4,5	0,08	White/Blue
40646	8,0	3,5	0,08	White/Blue
40638	13,0	6,0	0,50	White/Blue
40647	16,5	4,5	0,45	White/Blue

Original Weck



Weck-Flaschen, 6er Set

Weck-bottles, 6 pcs.
Weck-botellas, set de 6
Weck-bouteilles, set de 6



6 Flaschen + 6 Deckel, ideal zum Servieren von Saft, Smoothie, Dressing und Saucen
6 bottles + 6 covers, ideal for serving juice, smoothie, dressing and sauces
6 botellas + 6 tapas, ideal para servir zumo, licuado, aliño y salsas
6 bouteilles + 6 couvercles, idéal pour servir de jus, smoothie, vinaigrette et sauces

	Ø cm	↑ cm	ltr.	pcs
82307	6	14,5	0,25	6



Weck-Flaschen, 6er Set

Weck-bottles, 6 pcs.
Weck-botellas, set de 6
Weck-bouteilles, set de 6



6 Flaschen + 6 Deckel, ideal zum Servieren von Saft, Smoothie, Dressing und Saucen
6 bottles + 6 covers, ideal for serving juice, smoothie, dressing and sauces
6 botellas + 6 tapas, ideal para servir zumo, licuado, aliño y salsas
6 bouteilles + 6 couvercles, idéal pour servir de jus, smoothie, vinaigrette et sauces

	Ø cm	↑ cm	ltr.	pcs
82308	6	19	0,5	6



Weck-Flaschen, 6er Set

Weck-bottles, 6 pcs.
Weck-botellas, set de 6
Weck-bouteilles, set de 6



6 Flaschen + 6 Deckel, ideal zum Servieren von Saft, Smoothie, Dressing und Saucen
6 bottles + 6 covers, ideal for serving juice, smoothie, dressing and sauces
6 botellas + 6 tapas, ideal para servir zumo, licuado, aliño y salsas
6 bouteilles + 6 couvercles, idéal pour servir de jus, smoothie, vinaigrette et sauces

	Ø cm	↑ cm	ltr.	pcs
82309	6	25,5	1,0	6

GLASSES



Tulpenform

Weck-Gläser mit Deckel, 12er Set

Weck-glasses with lid, 12 pcs.
Weck tarros de vidrio con tapa, set de 12
Weck verrines avec couvercle, set de 12

GLAS
GLASS



12 Gläser + 12 Deckel
12 glasses + 12 covers
12 vasos + 12 tapas
12 verrines + 12 couvercles

	Ø cm	↑ cm	ltr.	pcs
82316	7	8,0	0,22	12



Sturzform

Weck-Gläser mit Deckel, 12er Set

Weck-glasses with lid, 12 pcs.
Weck tarros de vidrio con tapa, set de 12
Weck pots en verre avec couvercle, set de 12

GLAS
GLASS



12 Gläser + 12 Deckel
12 glasses + 12 cover
12 vasos + 12 tapas
12 verrines + 12 couvercles

	Ø cm	↑ cm	ltr.	pcs
82345	9	6	0,20	12



Sturzform

Weck-Gläser mit Deckel, 3er Set

Weck-glasses with lid, 3 pcs.
Weck tarros de vidrio con tapa, set de 3
Weck verrines avec couvercle, set de 3

GLAS
GLASS



3 Gläser + 3 Deckel
3 glasses + 3 covers
3 vasos + 3 tapas
3 verrines + 3 couvercles

	Ø cm	↑ cm	ltr.	pcs
82346	11	7,5	0,37	3



Sturzform

Weck-Gläser mit Deckel, 2er Set

Weck-glasses with lid, 2 pcs.
Weck tarros de vidrio con tapa, set de 2
Weck verrines avec couvercle, set de 2

GLAS
GLASS



2 Gläser + 2 Deckel
2 glasses + 2 covers
2 vasos + 2 tapas
2 verrines + 2 couvercles

	Ø cm	↑ cm	ltr.	pcs
82347	11	11	0,58	2



Sturzform

Gourmetgläser, 12er Set

gourmet glasses, 12 pcs.
tarros gourmet, set de 12
verres gourmet, set de 12

GLAS
GLASS



	Ø cm	↑ cm	ltr.	pcs
82359	5	3,5	0,035	12
82370	6	5,5	0,08	12
82371	6	8,0	0,16	12

12er Set ohne Deckel
12 pcs. set without cover



Weck-Gläser mit Deckel, 12er Set

Weck-glasses with lid, 12 pcs.
Weck tarros de vidrio con tapa, set de 12
Weck verrines avec couvercle, set de 12



12 Gläser + 12 Deckel

12 glasses + 12 covers
12 tarros + 12 tapas
12 verrines + 12 couvercles

	Ø cm	↑ cm	ltr.	pcs
82350	5,5	6	0,075	12



Weck-Gläser mit Deckel, 12er Set

Weck-glasses with lid, 12 pcs.
Weck tarros de vidrio con tapa, set de 12
Weck verrines avec couvercle, set de 12



12 Gläser + 12 Deckel

12 glasses + 12 covers
12 tarros + 12 tapas
12 verrines + 12 couvercles

	Ø cm	↑ cm	ltr.	pcs
82351	5,5	9	0,145	12

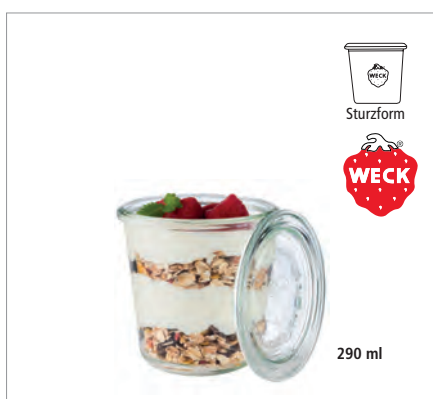

Weck-Gläser mit Deckel, 6er Set

Weck-glasses with lid, 6 pcs.
Weck tarros de vidrio con tapa, set de 6
Weck verrines avec couvercle, set de 6



6 Gläser + 6 Deckel

6 glasses + 6 covers
6 tarros + 6 tapas
6 verrines + 6 couvercles

	Ø cm	↑ cm	ltr.	pcs
82352	9	9	0,29	6



Weck-Gläser mit Deckel, 6er Set

Weck-glasses with lid, 6 pcs.
Weck tarros de vidrio con tapa, set de 6
Weck verrines avec couvercle, set de 6



6 Gläser + 6 Deckel

6 glasses + 6 covers
6 tarros + 6 tapas
6 verrines + 6 couvercles

	Ø cm	↑ cm	ltr.	pcs
82354	11	9	0,58	6



Original WECK



370 ml



370 ml



580 ml



580 ml



Sturzform



370 ml

Weck-Gläser mit Deckel, 2er Set

Weck-glasses with lid, 2 pcs.
Weck tarros de vidrio con tapa, set de 2
Weck verrines avec couvercle, set de 2

2 Gläser + 2 Edelstahl Deckel
2 glasses + 2 stainless steel lids
2 tarros + 2 tapas de acero inoxidable
2 verrines + 2 couvercles en acier inox



	Ø cm	↑ cm	ltr.	pcs
82239	11	7,5	0,37	2



Sturzform



580 ml

Weck-Gläser mit Deckel, 2er Set

Weck-glasses with lid, 2 pcs.
Weck tarros de vidrio con tapa, set de 2
Weck verrines avec couvercle, set de 2

2 Gläser + 2 Edelstahl Deckel
2 glasses + 2 stainless steel lids
2 tarros + 2 tapas de acero inoxidable
2 verrines + 2 couvercles en acier inox



	Ø cm	↑ cm	ltr.	pcs
82240	11	11	0,58	2

klappbar
foldable



370 ml

Weck-Gläser mit Deckel, 2er Set

Weck-glasses with lid, 2 pcs.
Weck tarros de vidrio con tapa, set de 2
Weck verrines avec couvercle, set de 2

2 Gläser + 2 Edelstahl Deckel
2 glasses + 2 stainless steel lids
2 tarros + 2 tapas de acero inoxidable
2 verrines + 2 couvercles en acier inox



	Ø cm	↑ cm	ltr.	pcs
82241	11	7,5	0,37	2

klappbar
foldable



580 ml

Weck-Gläser mit Deckel, 2er Set

Weck-glasses with lid, 2 pcs.
Weck tarros de vidrio con tapa, set de 2
Weck verrines avec couvercle, set de 2

2 Gläser + 2 Edelstahl Deckel
2 glasses + 2 stainless steel lids
2 tarros + 2 tapas de acero inoxidable
2 verrines + 2 couvercles en acier inox



	Ø cm	↑ cm	ltr.	pcs
82242	11	11	0,58	2



NEW

82241

Tablett
tray
30130

Deckel klappbar
lid foldable
82242



370 ml

Weck-Gläser mit Deckel, 2er Set

Weck-glasses with lid, 2 pcs.
Weck tarros de vidrio con tapa, set de 2
Weck verrines avec couvercle, set de 2

2 Gläser + 2 Holz Deckel
2 glasses + 2 wooden lids
2 tarros + 2 tapas de madera
2 verrines + 2 couvercles en bois



	Ø cm	↑ cm	ltr.	pcs
82243	11	7,5	0,37	2



580 ml

Weck-Gläser mit Deckel, 2er Set

Weck-glasses with lid, 2 pcs.
Weck tarros de vidrio con tapa, set de 2
Weck verrines avec couvercle, set de 2

2 Gläser + 2 Holz Deckel
2 glasses + 2 wooden lids
2 tarros + 2 tapas de madera
2 verrines + 2 couvercles en bois



	Ø cm	↑ cm	ltr.	pcs
82244	11	11	0,58	2

Deckel für Weck-Gläser / lids for Weck-glasses

	Ø cm	↑ cm	fits to
82362	11	2	82243, 82244, 82346, 82347
82360	10,5	2	82239, 82240, 82346, 82347
82361	10,5	4,5	82241, 82242, 82346, 82347



82362

82360

82361



00898



82244



82240

GLASSES



passende Gläser
matching glasses
82310
82312
82314

Serviergestell „WECK“

serving stand
expositor
présentoir

ohne Gläser
without glasses
sin vasos
sans verrines



	Ø cm	↑ cm	
33247	22	33	6 x Ø 6 cm



passende Gläser
matching glasses
82310
82312
82314

Serviergestell „WECK“

serving stand
expositor
présentoir

ohne Gläser
without glasses
sin vasos
sans verrines



	Ø cm	↑ cm	
33246	22	59	12 x Ø 6 cm



Weck-Gläser mit Deckel, 12er Set

Weck-glasses with lid, 12 pcs.
Weck tarros de vidrio con tapa, set de 12
Weck verrines avec couvercle, set de 12



12 Gläser + 12 Deckel
12 glasses + 12 covers
12 vasos + 12 tapas
12 verrines + 12 couvercles

	Ø cm	↑ cm	ltr.	pcs
82310	6	5,5	0,08	12
82312	6	7,0	0,14	12
82314	6	8,0	0,16	12

**Weck-Frischhaltecover, 5er Set**

airtight cover, 5 pcs.
tapa hermética, set de 5
couvercle hermétique, set de 5

für Rundrandgläser Ø 6 cm, 5er Set

for Ø 6 cm glasses, 5 pcs. set
para vasos Ø 6 cm, set de 5
pour verrines Ø 6 cm, set de 5



	Ø cm	pcs.
82338	7	5

**Gummidichtringe, 10er Set**

rubber washer, 10 pcs.
juntas de goma, set de 10
joints de caoutchouc, set de 10

für Deckel der Weck-Gläser, im Beutel verpackt

for covers of Weck-glasses
para las tapas de los tarritos Weck
pour la fermeture des verrines Weck

	fits to	pcs.
82318	82307, 82308, 82309, 82310, 82312, 82314, 82316	10
82394	82345	10
82395	82346, 82347	10

**8er Set Deckel-Klammer für 4 Weck-Gläser**

8 pcs. cover clamps for 4 Weck-glasses
8 abrazaderas para 4 vasitos Weck
8 agrafes pour 4 verrines Weck



	pcs.
82319	8



Topf darf nicht erhitzt werden!
Topf ist nicht zum Kochen geeignet!

Muscheltopf

mussel pot
mejillonera
casserole à moules

schwarz emailliertes Stahlblech, mit Edelstahlrand

black enamelled steel, stainless steel rim

hierro esmaltado negro, borde inox

acier émaillé noir, bord inox



	Ø cm	↑ cm	Topf / pot ltr.	Deckel / lid ltr.
00623	13,5	9,0	0,75	0,60
00625	18,0	12,0	2,60	1,40
00626	20,0	13,0	3,30	1,60
00627	24,0	13,5	5,20	2,70



ACACIA



Servier- und Tortenplatte „ACACIA MINI“

cake stand
porta pasteles
présentoir à gâteaux

Akazienholz geölt
acacia wood oiled
madera de acacia aceitada
bois d'acacia huilé

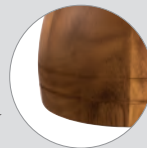

	Ø cm	↑ cm
33290	9,5	7
33291	13,0	9



Servier- und Tortenplatte „ACACIA“

cake stand
porta pasteles
présentoir à gâteaux

Akazienholz geölt, mit möbelschonender Unterseite
acacia wood oiled, with non-scratching undersurface
madera de acacia aceitada, con base anti rayaduras
bois d'acacia huilé, avec revêtement antirayures



	Ø cm	↑ cm
33292	24,0	8
33293	24,0	16
33294	33,0	8
33295	33,0	16
33296	38,5	8
33297	38,5	16

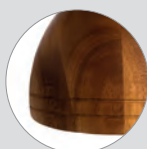

Frischhalte- Haube / cover / campana / cloche



	Ø cm	↑ cm	fits to
06519	21	17	33292, 33293
06520	30	22	33294, 33295
06521	36	27	33296, 33297



Torten- / Konditorplatte „SLATE“

cake stand
soporte para pastel
présentoir à gâteaux

Rand fixiert die Haube, mit Antirutsch-Füßchen
carved edge fixes the cover, with non-slip feet
ranura para fijar bien la campana, con pies antideslizantes
bord rainuré pour maintenir ferme la cloche, avec pieds antidérapants



	Ø cm	↑ cm	fits to
85046	21,5	2,5	06519
85047	30,5	3,5	06520, 06512
85048	37,5	4,0	06521



Torten- / Konditorplatte „LOOPS“

cake stand
soporte para pastel
présentoir à gâteaux

	Ø cm	↑ cm	fits to
85033	21,5	2,5	06519
85034	30,5	3,5	06520, 06512, 06510
85035	37,5	4,0	06521



Torten- / Konditorplatte

cake stand
soporte para pastel
présentoir à gâteaux

Rand fixiert die Haube, mit Antirutsch-Füßchen
carved edge fixes the cover, with non-slip feet
ranura para fijar bien la campana, con pies antideslizantes
bord rainuré pour maintenir ferme la cloche, avec pieds antidérapants



	Ø cm	↑ cm	Farbe / Colour
00468	31,0	3,5	White
00469	31,0	3,5	Black



Servier- und Tortenplatte „CASUAL“

cake plate
porta pasteles
présentoir à gâteaux

	Ø cm	↑ cm
83890	31	8
83891	31	16



Konditorplatte

cake stand
soporte para pastel
présentoir à gâteaux

matt poliert / satin polished finish / acabado efecto satinado / poli mat effet satin



	Ø cm	↑ cm
00046	31	3

CAKE STAND



Servier- und Tortenplatte

cake stand
porta pasteles
présentoir à gâteaux



Eichenholz geölt, mit Antirutsch-Füßchen
oak wood oiled with non-slip feet
madera de roble aceitada, con pies antideslizantes
bois de chêne huilé, avec pieds antidérapants

	Ø cm	↑ cm
00818	32	2,0



Präsentationsmöglichkeit
presentation example



Servier- und Tortenplatte „CLASSIC“

cake stand
porta pasteles
présentoir à gâteaux



Rand fixiert die Haube
carved edge fixes the cover
ranura para fijar bien la campana
bord rainuré pour maintenir ferme la cloche

	Ø cm	↑ cm
85051	30,5	9
85052	30,5	17



Servier- / Tortenplatte

cake stand
soporte para pastel
présentoir à gâteaux



matt poliert, drehbar, möbelschonende Moosgummi-Unterseite
satin polished finish, rotating, foam rubber below to save your furniture
acabado pulido satinado, giratorio, base revestida de goma para no rallar el mobiliario
poli satiné, plateau tournant, revêtement mousse sous le pied pour ne pas rayer les meubles

	Ø cm	↑ cm
00463	30,5	9



Servier- / Tortenplatte

cake stand
soporte para pastel
présentoir à gâteaux



Fuß matt poliert, drehbar, möbelschonende Moosgummi-Unterseite
foot satin polished finish, rotating, foam rubber below to save your furniture
vidrio, pie inox satinado giratorio, base de goma para proteger el mobiliario
plateau en verre, pied tournant inox poli satin, revêtement mousse sous le pied anti-rayures

	Ø cm	↑ cm
00444	30	7



Sauciere
gravy boat
salsera
saucière

hochglanzpoliert, extra schwere Qualität
mirror polished finish, high quality
acabado efecto espejo, alta calidad, base pesada
poli brillant, belle qualité, pied pesant



	cm	↑ cm	ltr.
40208	13 x 6,0	9,0	0,075
40204	16 x 7,5	9,0	0,125
40205	19 x 9,0	13,0	0,25
40206	22 x 10,5	13,5	0,4



Sauciere
gravy boat
salsera
saucière

poliert / polished / pulido / poli



	cm	↑ cm	ltr.
40200	18,0 x 7,5	7,0	0,10
40203	21,5 x 9,5	8,5	0,15
40201	23,5 x 10,0	10,0	0,20
40202	23,5 x 12,0	12,0	0,45



Thermo-Sauciere
insulated sauce boat
salsera isotérmica
saucière thermique

doppelwandig, Klappdeckelverschluss, Einhandbedienung
double wall, hinged cover, one-hand operation
doble pared, tapa con bisagra, se maneja con 1 mano
double paroi, couvercle avec charnière, usage 1 main



	cm	↑ cm	ltr.
40207	19 x 12,5	13	0,4

PLATE TRAYS



Glocke

cloche / dome cover
campana esférica
cloche demi-sphère



außen hochglanzpoliert, innen matt poliert, mit verchromten Griff
outside mirror polished finish, inside satin polished finish, with chromeplated handle
exterior pulido acabado efecto espejo, interior pulido acabado efecto satinado, pomo cromado
extérieur poli brillant, intérieur poli satin, buton chromé

	Ø cm	↑ cm
35734	29	18



Platzteller

plate tray
bajo plato
assiette de présentation



hochglanzpoliert, Rand ingerollt
mirror polished finish, rolled edge
pulido efecto espejo, borde redondeado
poli miroir, bord rond

	Ø cm
35735	31



Platzteller

plate tray
bajo plato
assiette de présentation



hochglanzpoliert, mit Fadendekor
mirror polished finish, with line edge
pulido efecto espejo, con un filo en relieve
poli miroir, filet relief

	Ø cm
35730	30,5
36233	33,0



Platzteller

plate tray
bajo plato
assiette de présentation



hochglanzpoliert, mit Perlrand
mirror polished finish, with pearl edge
acabado pulido efecto espejo, con borde aperlado
poli miroir, bord perlé

	Ø cm
35720	30,5
36323	33,0



Tischkrümelentferner

crumbler
recogemigas
ramasse-miettes



matt poliert / satin polished finish / acabado mate, fácil de usar, mango hueco
mat satiné, manche creux, simple à utiliser

	Ø cm	↑ cm	
00058	6,5 x 2,5	22	Hohlgriff / hollow handles
00581	19,0 x 4,5	1	geschliffene Edelstahlkante flat grinded stainless steel edge



Untersetzer, 6er Set

coaster, 6 pcs.
posavasos, set de 6
plateau sous-verre, set de 6



hochglanzpoliert, schwere Ausführung, Rand eingerollt
mirror polished finish, heavy quality, rolled edge
acabado pulido efecto espejo, alta calidad, borde redondeado
effet miroir, bord rond, qualité extra

	Ø cm	pcs.
35711	10	6
35912	12	6



Serviettenringe, 4er Set

napkin rings, 4 pcs.
servilleteros, set de 4
anneaux porte-serviette, set de 4



	Ø cm	↑ cm	pcs.
04446	4,5	2,5	4



Rechnungstablett

bill presenter
porta cuenta
porte-addition



mit Klemme für Rechnung
with clip for bill
con clip para la nota
avec clip pour la note

	cm	↑ cm	Material / material
30108	20 x 12	0,5	ABS Kunststoff / ABS plastic
30110	17 x 11	1,0	Edelstahl / stainless steel

TABLE CUTLERY BIN



Besteckkorb „ECONOMIC“

cutlery dispenser
dispensador de cubiertos
corbeille à couverts



in Handarbeit geflochten

wickerwork
trensado a mano
tressage à main

	Ø cm	↑ cm	Farbe / Colour
40130	12	15	
40007	12	15	
40012	12	15	
40013	12	15	



Besteckkorb „ECONOMIC“

cutlery dispenser
dispensador de cubiertos
corbeille à couverts



in Handarbeit geflochten

wickerwork
trensado a mano
tressage à main

	cm	↑ cm	Farbe / Colour
40131	27 x 10	4,5	
40009	27 x 10	4,5	
40010	27 x 10	4,5	
40011	27 x 10	4,5	



Table Caddy „COUNTRY STYLE“

table barrel
caddy de mesa
caddy de table



cooler Country-Style, nicht für den direkten Kontakt mit Lebensmitteln verwendbar

condiment and cutlery holders or even for food presentation, the mini barrels should not come into contact with food, they should be lined with our greaseproof paper

estilo campo, no aptos para el contacto directo con alimentos, sólo usando papel alimenticio

de style champêtre, pas de contact direct avec aliments, seulement en utilisant papier alimentaire

	Ø cm	↑ cm
11930	17,5	8,5
11931	11,5	14,0



Tischreste- / Besteckbehälter „TOP CHROME“

table waste bin / cutlery bin
 papelera de sobremesa / recipiente para cubiertos
 poubelle de table / récipients pour couverts



mit verchromten Rand
 with chrome plated ring
 con anillo cromado
 avec bord chromé

	Ø cm	↑ cm	ltr.	Farbe / Colour
00025	13	15	1	
00026	13	15	1	



Tischreste- / Besteckbehälter „BASE CHROME“

table waste bin / cutlery bin
 papelera de sobremesa / recipiente para cubiertos
 poubelle de table / récipients pour couverts



mit verchromten Boden
 with chrome bottom
 con base cromada
 avec base chromée

	Ø cm	↑ cm	ltr.	Farbe / Colour
00019	13	15	1,3	
00020	13	15	1,3	



Besteckköcher

cutlery basket
 cesta para cubiertos
 corbeille à couverts



	Ø cm	↑ cm	
11998	9,7	13,7	Kunststoff weiß / white plastic plástico blanco / plastique blanc
11999	9,7	13,7	matt poliert / satin polished finish acero inoxidable / inox

11998
Köcher weiß

11999
Köcher Edelstahl



Tischreste- / Besteckbehälter

table garbage bin / cutlery bin
 papelera de sobremesa / recipiente para cubiertos
 poubelle de table / récipients pour couverts



matt poliert, mit abnehmbaren Lochdeckel
 satin polished finish, with removeable cover
 acabado pulido satinado, con tapa desmontable
 poli mat satiné, avec couvercle démontable ouvert au centre

	Ø cm	↑ cm	ltr.
00028	10	12	0,7



Tischrestebehälter

table garbage bin
papelera de sobremesa
poubelle de table



matt poliert, abnehmbarer Schwingdeckel, mit Bajonettverschluss „fester Deckelsitz“
satin polished finish, swing cover, cover removable
acabado satinado, tapa basculante desmontable
poli mat satiné, couvercle basculant démontable

	Ø cm	↑ cm	ltr.
00029	12	17	1,2
00027	10	13	0,7



Tischrestebehälter

table garbage bin
papelera de sobremesa
poubelle de table



Behälter aus weiß lackiertem Metall, Edelstahl-Lochdeckel
metall white, stainless cover with hole
tapa, acero inoxidable, con apertura
couvercle inox, avec ouverture centrale, récipient en acier laqué blanc

	Ø cm	↑ cm	ltr.
00292	12	15	1,2



Tischreste- / Besteckbehälter

table waste bin / cutlery bin
papelera de sobremesa / recipiente para cubiertos
poubelle de table / récipients pour couverts



mit verchromten Rand, inkl. herausnehmbarem Einteiler (4 Fächer)
with chrome plated ring, incl. divider (4 chambers)
con anillo cromado
avec bord chromé

	cm	↑ cm	Farbe / Colour
00016	14 x 14	16	■



Tischrestebehälter „SUNDAY“

table waste bin
papelera de sobremesa
poubelle de table



matt poliert, inkl. Deckel, fester Deckelsitz
satin polished finish, incl. cover, cover removeable
acero inoxidable mate, con tapa
inox mat, avec couvercle

	Ø cm	↑ cm	ltr.
00024	10	18	1,1



Besteckbehälter „TIN“

cutlery bin
recipiente
récipient



Behälter aus Metall mit Tragegriff aus Holz
container made of metal with wooden handle
contenedor de metal con asa de madera
conteneur métallique avec poignée en bois

	cm	↑ cm
00014	24,5 x 12	18,5



Besteckköcher

cutlery basket
cesta para cubiertos
corbeille à couverts



	cm	↑ cm	Farbe / Colour
84535	12 x 12	16	White
84536	12 x 12	16	Black



Abtropflöcher
drainer holes



Besteckständer

cutlery basket
porta cubiertos
porte-couverts



Behälter aus Edelstahl, matt poliert
container made of stainless steel, matt polished
contenedor de acero inoxidable, pulido mate
conteneur en acier inox, poli mat

	Ø cm	↑ cm
11921	10	10,0
11922	12	13,5

TABLE GARBAGE BIN



Tischrestebehälter
table garbage bin
papelera de sobremesa
poubelle de table



	Ø cm	↑ cm	ltr.	Farbe / Colour
02038	11	14	0,9	White
02039	11	14	0,9	Black



Tischrestebehälter
table garbage bin
papelera de sobremesa
poubelle de table



	Ø cm	↑ cm	ltr.
00311	14	15	1,2



Tischrestebehälter
table garbage bin
papelera de sobremesa
poubelle de table



Kunststoff weiß / granit, abnehmbarer Schwingdeckel
white plastic, swing cover, cover removable
plástico blanco/granito, tapa basculante desmontable
plastique blanc/gris chiné, couvercle basculant démontable

	Ø cm	↑ cm	ltr.
00031	12	18	1,4



Tischrestebehälter „INTERNATIONAL“
table waste bin
papelera de sobremesa
poubelle de table



Deckel-Ring mit Dichtung, internationale Beschriftung
cover with sealing ring, internationale Beschriftung
tapa con junta, texto multi-idomas
couvercle avec joint, texte multilingue

	Ø cm	↑ cm	ltr.
83847	10	17,5	1



Tischrestebehälter
table garbage bin
papelera de sobremesa
poubelle de table



	Ø cm	↑ cm	ltr.
83999	13 / 9	14	1,2



Besteckbehälter „ELEMENT“

cutlery bin
 recipiente para cubiertos
 récipients pour couverts



mit Abflussloch, mit weißem Logo, Bodeneinlage aus Silikon zum Schonen des Bestecks, mit möbelschonender Unterseite
 with drain hole, with white logo, silicone floor inserts for saving the cutlery, with non-scratching undersurface
 con orificio de drenaje, con logotipo blanco, base de silicona para proteger la cubertería, con base anti rayaduras
 avec trou de drainage, avec logo blanc, insert de silicone pour protéger la coutellerie, avec revêtement antirayures

	Ø cm	↑ cm	Logo
11935	12	14	fork
11936	12	14	knife
11937	12	14	spoon



Besteckbehälter „ELEMENT“

cutlery bin
 recipiente para cubiertos
 récipients pour couverts



mit Abflussloch, mit Besteck Logo, Bodeneinlagen aus Silikon zum Schonen des Bestecks, mit möbelschonender Unterseite
 with drain hole, with cutlery logo, silicone floor inserts for saving the points of knives, with non-scratching undersurface
 con orificio de drenaje, con logotipo de cubertería, soporte de silicona para proteger las puntas de los cuchillos, con base antirrayaduras
 avec le trou de drainage, avec le logo de coutellerie, insert de silicone pour protéger les pointes des couteaux, avec base revêue antirayures

	Ø cm	↑ cm
00018	11	14



Besteckbehälter „ACACIA“

cutlery bin
 recipiente para cubiertos
 récipients pour couverts



Akazienholz natur
 acacia wood nature
 madera de acacia natural
 bois d'acacia naturelle

	cm	↑ cm	Logo
11939	14 x 14	15	fork / knife / spoon

NEW **MENU HOLDER**

zum Einschieben der Speisekarten – schneller Austausch jederzeit möglich!
for inserting the menus - quick exchange possible at any time!

Der Kartenhalter ist völlig unkompliziert zu handhaben, denn er verfügt über eine Vorrichtung, in die die Karten einfach eingeschoben und schnell ausgetauscht werden können.

The menu holder is completely uncomplicated to handle, because it has a device into which the cards can simply be inserted and quickly exchanged.

El uso del porta menús es totalmente sencillo, ya que dispone de un dispositivo en el que simplemente se introducen las tarjetas y se intercambian rápidamente.

L'utilisation du porte-cartes est très simple, car il dispose d'un dispositif dans lequel les cartes peuvent être simplement insérées et rapidement échangées.

DIN A6

71521

Kartenhalter 2-teilig

menu holder, 2 pcs.
porta menús, set de 2
porte-cartes, set de 2



1 Fuß aus Edelstahl, 1 Menühalter aus Acryl
1 stainless steel base, 1 menu holder made of acrylic
1 base de acero inoxidable, porta menús acrílico
1 base en acier inox, porte-cartes en acrylique

	cm	↑ cm		
71521	10,5 x 7	17	stainless steel	
71527	10,5 x 7	17	black	

DIN A5

71528

Kartenhalter 2-teilig

menu holder, 2 pcs.
porta menús, set de 2
porte-cartes, set de 2



1 Fuß aus Edelstahl, 1 Menühalter aus Acryl
1 stainless steel base, 1 menu holder made of acrylic
1 base de acero inoxidable, porta menús acrílico
1 base en acier inox, porte-cartes en acrylique

	cm	↑ cm		
71522	15 x 7	23	stainless steel	
71528	15 x 7	23	black	

DIN A4

71523

Kartenhalter 2-teilig

menu holder, 2 pcs.
porta menús, set de 2
porte-cartes, set de 2



1 Fuß aus Edelstahl, 1 Menühalter aus Acryl
1 stainless steel base, 1 menu holder made of acrylic
1 base de acero inoxidable, porta menús acrílico
1 base en acier inox, porte-cartes en acrylique

	cm	↑ cm		
71523	21 x 7	32	stainless steel	
71529	21 x 7	32	black	



Mini Staffelei, 2 teilig

easel mini, 2 pcs.
caballete mini, set de 2
chevale mini, set de 2

HOLZ
WOOD

1 Ständer aus Akazienholz, 1 Schild kann senkrecht oder waagrecht verwendet werden
1 acacia wood stand, 1 sign can be used vertically or horizontally
1 soporte de madera de acacia, 1 el cartel se puede utilizar vertical u horizontalmente
1 support en bois d'acacia, 1 le panneau peut être utilisé verticalement ou horizontalement

	cm	↑ cm
71520	13,5 x 10,0	19



waagrecht
horizontal



senkrecht
vertical

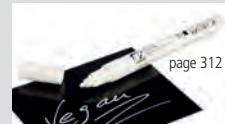

page 312

71490 Kreide-Marker
chalk marker

Inhalt ohne Stift
content without pen
contenido sin bolígrafo
contenu sans stylo



71496

71497

Kartenhalter „ELEMENT“, 2 teilig

menu holder, 2 pcs.
soporte de tarjeta de menú, set de 2
porte-cartes de menu, set de 2

BETON
CONCRETE

ACRYL
ACRYLIC

1 Fuß aus Beton, 1 Menühalter aus Acryl
1 concrete base, 1 acrylic menu sign / holder
1 base de hormigón, 1 letrero de menú acrílico
1 socle en béton, 1 plaque de menu en acrylique

	cm	↑ cm
71496	11,5 x 4,5	10
71497	15,5 x 6,5	26



6 Stck. Halter
12 Stck. Karten

Kartenhalter-Set

card holder set
portatarjetas, set
porte-cartes, set

PP
POLYPROPYLEN

METALL
VERCHROMT

18-teilig: 6 Kartenhalter 4 x 2,5 cm + 12 Kunststoff-Beschriftungskarten 10 x 6 cm
18 pcs. set: 6 card holder 4 x 2,5 cm + 12 plastic cards of inscription 10 x 6 cm
set de 18: 6 soportes 4 x 2,5 cm + 12 tarjetas de plástico 10 x 6 cm
set de 18: 6 supports 4 x 2,5 cm + 12 étiquettes en plastique 10 x 6 cm

	cm
00022	4 x 2,5

MENU HOLDER

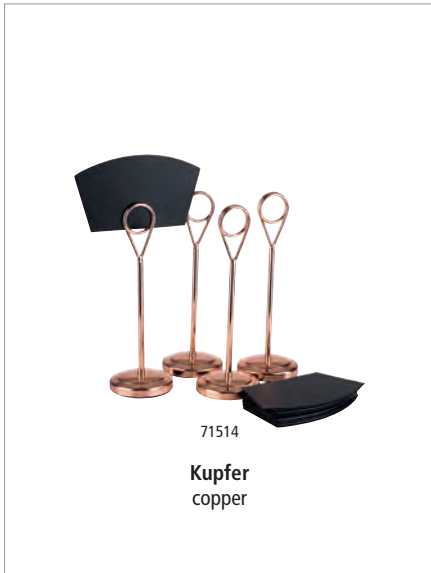

Kartenhalter, 4er Set

table stands, 4 pcs.
portatarjetas, set de 4
porte-cartes, set de 4



hochglanzpoliert, inkl. 20 schwarze Beschriftungskarten aus Polypropylen
mirror polished finish, incl. 20 black cards made of polypropylene
pulido brillante, incl. 20 tarjetas negras de polipropileno
poli miroir, incl. 20 étiquettes noires en polypropylène

	Ø cm	↑ cm	pcs.	Farbe / Colour	
71511	5	10,5	4		copper
71514	5	15,5	4		copper
71517	5	20,5	4		copper

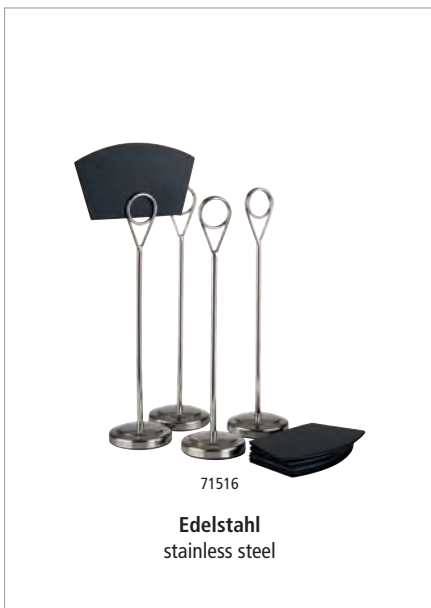

Kartenhalter, 4er Set

table stands, 4 pcs.
portatarjetas, set de 4
porte-cartes, set de 4



hochglanzpoliert, inkl. 20 schwarze Beschriftungskarten aus Polypropylen
mirror polished finish, incl. 20 black cards made of polypropylene
pulido brillante, incl. 20 tarjetas negras de polipropileno
poli miroir, incl. 20 étiquettes noires en polypropylène

	Ø cm	↑ cm	pcs.	Farbe / Colour	
71510	5	10,5	4		stainless steel
71513	5	15,5	4		stainless steel
71516	5	20,5	4		stainless steel

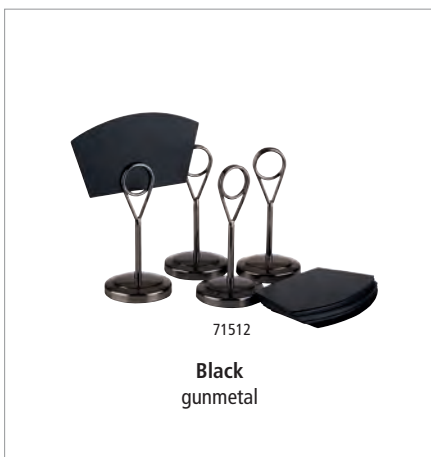

Kartenhalter, 4er Set

table stands, 4 pcs.
portatarjetas, set de 4
porte-cartes, set de 4



hochglanzpoliert, inkl. 20 schwarze Beschriftungskarten aus Polypropylen
mirror polished finish, incl. 20 black cards made of polypropylene
pulido brillante, incl. 20 tarjetas negras de polipropileno
poli miroir, incl. 20 étiquettes noires en polypropylène

	Ø cm	↑ cm	pcs.	Farbe / Colour	
71512	5	10,5	4		gunmetal
71515	5	15,5	4		gunmetal
71518	5	20,5	4		gunmetal



Beschriftungskarten, 10er Set

designation cards, 10 pcs.
tarjetas, set de 10
étiquettes, set de 10



	cm	* mm
00037	7,5 x 5	0,4



Bankettkartenständer

menu stand / table number
 porta-etiqueta o carta de sobremesa
 porte-étiquette de table, porte-menu, ou n° de table



hochglanzpoliert, schwere Qualität
 mirror polished finish, heavy gauge
 acero inoxidable de alta calidad
 inox, belle qualité

	Ø cm	↑ cm
71460	7,5	18,5
71461	7,5	29
71462	7,5	46



Tischkartenhalter, 4er Set

table stands, 4 pcs.
 pinzas porta-etiquetas, set de 4
 porte-étiquettes à pince, set de 4



hochglanzpoliert, schwerer Fuß, inkl. 20 weiße Beschriftungskarten
 mirror polished finish, heavy foot, incl. 20 white labels
 acabado brillante, incluye 20 etiquetas en blanco
 poli brillant, inclut 20 étiquettes blanches

	Ø cm	↑ cm	pcs.
00070	4	10	4



Tischaufsteller, 10er Set

table stands, 10 pcs.
 caballes de mesa, set de 10
 chevalets de table, set de 10



Ecken abgerundet
 corners rounded
 esquinas redondeadas
 coins arrondies

	cm	↑ cm	pcs.
00011	7,5 x 3,5	5	10
00012	10,5 x 6	6,5	10



Kartenhalter, 2er Set

card holder, 2 pcs.
 soporte de mesa, set de 2
 support de table, set de 2



inkl. 40 Beschriftungskarten, durch Magnete einfach zusammenklappbar
 incl. 40 cards, easily foldable with magnets
 incluye 40 tarjetas, fácil de plegar, con imanes
 inclut 40 étiquettes, fácil à plier, avec aimants

	cm	↑ cm	pcs.
00076	9 x 3	5,5	2

MENU HOLDER

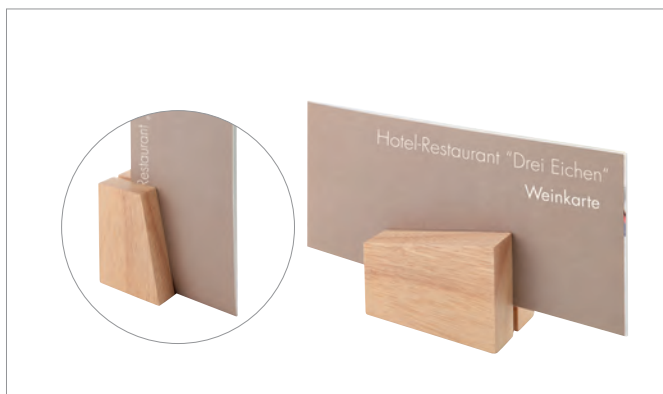

Kartenhalter, 2er Set

menu holder, 2 pcs.
porta cartas de mesa, set de 2
supports pour menu de table, set de 2

HOLZ
WOOD



	cm	↑ cm	pcs.
00023	8,5 x 6	4,5 / 8,5	2



Kartenhalter, 2er Set

menu holder, 2 pcs.
porta cartas de mesa, set de 2
porte-menus de table, set de 2

EDELSTAHL
STAINLESS
INOX



matt poliert

satin polished finish
pulido satinado
poli mat satiné

	cm	↑ cm	pcs.
00021	8,5 x 4	4 / 8,5	2



Tischkartenhalter

table stand
soporte-carta para la mesa
support pour menu de table

EDELSTAHL
STAINLESS
INOX



matt poliert

satin polished finish
pulido satinado
poli mat satiné

	cm	↑ cm	pcs.
00030	8 x 7,0	2	1
00036	6 x 4,5	4	1

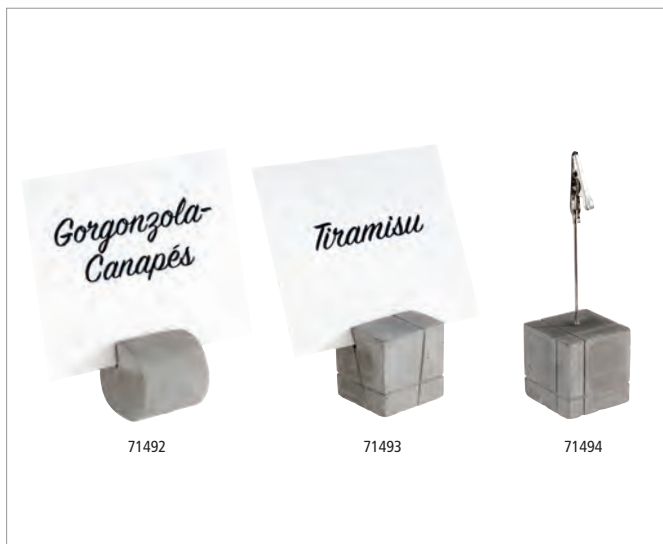

Kartenhalter-Set, 4er Set

table stands, 4 pcs.
portatarjetas, set de 4
porte-cartes, set de 4

BETON
CONCRETE



inkl. 30 Beschriftungskarten (15 x weiß + 15 x schwarz)

incl. 30 labels (15 x white + 15 x black)

incl. 30 tarjetas (15 x blanco + 15 x negro)

incl. 20 étiquettes (15 x blanc + 15 x noir)

	cm	↑ cm	pcs.
71492	3 x 3	3	4
71493	3 x 3	3	4
71494	3 x 3	12	4



Kartenhalter, 4er Set

table stands, 4 pcs.
soportes de mesa, set de 4
support de table, set de 4



inkl. 20 weiÙe Beschriftungskarten ca. 10 x 8 cm
incl. 20 white labels 10 x 8 cm
incluye 20 etiquetas blancas 10 x 8 cm
20 étiquettes blanches incluses 10 x 8 cm

	cm	↑ cm	pcs.	Farbe / Colour
00074	3 x 3	12	4	

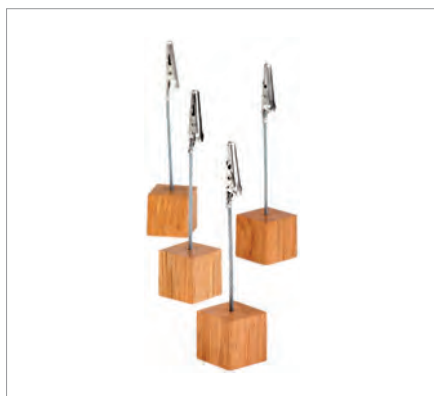

Kartenhalter, 4er Set

table stands, 4 pcs.
soportes de mesa, set de 4
support de table, set de 4



inkl. 20 weiÙe Beschriftungskarten ca. 10 x 8 cm
incl. 20 white labels 10 x 8 cm
incluye 20 etiquetas blancas 10 x 8 cm
20 étiquettes blanches incluses 10 x 8 cm

	cm	↑ cm	pcs.	Farbe / Colour
00700	2,5 x 2,5	12	4	



Kartenhalter „WÜRFEL“, 4er Set

table stands, 4 pcs.
soporte de mesa, set de 4
porte-étiquettes, set de 4



inkl. 20 weiÙe Beschriftungskarten ca. 10 x 8 cm, mehrfach beschriftbar
incl. 20 white labels 10 x 8 cm
incluye 20 etiquetas blancas 10 x 8 cm
20 étiquettes blanches incluses 10 x 8 cm

	cm	pcs.
00078	3 x 3 x 3	4



Kartenhalter „ZYLINDER“, 4er Set

table stands, 4 pcs.
soporte de mesa, set de 4
porte-étiquettes, set de 4



inkl. 20 weiÙe Beschriftungskarten ca. 10 x 8 cm, mehrfach beschriftbar
incl. 20 white labels 10 x 8 cm
incluye 20 etiquetas blancas 10 x 8 cm
20 étiquettes blanches incluses 10 x 8 cm

	cm	pcs.
00079	3 x 3 x 3	4



Tafelhalter / Schild

slate sign
caballete de mesa, pizarra
plaque signalétique avec support



	cm	↑ cm
00060	12 x 4	7

MENU HOLDER



Kartenhalter, 2er Set

table stands, 2 pcs.
portatarjetas, set de 2
porte-cartes, set de 2

BETON
CONCRETE



inkl. 30 Beschriftungskarten ca. 10 x 8 cm (15 x weiß + 15 x schwarz)
incl. 30 labels 10 x 8 cm (15 x white + 15 x black)
incl. 30 tarjetas 10 x 8 cm (15 x blanco + 15 x negro)
incl. 20 étiquettes 10 x 8 cm (15 x blanc + 15 x noir)

	cm	↑ cm	pcs.
71495	8 x 3,5	6	2



Kartenhalter, 2er Set „KLAMMER“

table stand, 2 pcs.
soporte de mesa, set de 2
support de table, set de 2

HOLZ
WOOD



inkl. 30 Beschriftungskarten ca. 10 x 8 cm (15 x weiß, 15 x schwarz)
incl. 30 cards 10 x 8 cm (15 x white, 15 x black)
incluye 30 tarjetas 10 x 8 cm (15 x blanco, 15 x negro)
inclut 30 étiquettes 10 x 8 cm (15 x blanc, 15 x noir)

	cm	↑ cm	pcs.	Farbe / Colour
71487	4 x 2,5	10	2	■
71489	4 x 2,5	10	2	■

Beschriftungskarten, 50 Stück / designation cards, 50 pcs. set
cartelitos de designación, 50 piezas / cartes de désignation, 50 pièces

	cm	pcs.	Farbe / Colour	fits to
71498	10 x 8	50	■	71487, 71489
71499	10 x 8	50	■	71487, 71489



Tischkartenhalter „PROFI“

table stand
soporte de mesa
support de table

METALL
VERCHROMT



	cm	↑ cm
40425	9,5 x 7,5	13,5



Tischkartenhalter

table stand
soporte de mesa
support de table

EDELSTAHL
STAINLESS
INOX



mit möbelschonender Unterseite
non-scratching undersurface
con base antirrayaduras
avec base revêtue antirayures

	cm	↑ cm
00071	14 x 5,5	14



Schilderhalter „FLEXIBEL“

sign holder
soporte para cartelito
support pour menu de table



biegsamer Draht mit zwei Klemmen, extrem flexibel, die Klemmen lassen sich weit öffnen
bedable metal coil adds visual interest, two metal clip open
metal cromado flexible, 2 pinzas con gran apertura
métal chromé, flexible, 2 pinces à grande ouverture

	→ cm	
71470	12	ohne Schilder / without signs sin cartelitos / sans étiquette
71471	23	ohne Schilder / without signs sin cartelitos / sans étiquette
71480	12	inkl. 10 Schilder 11879 / incl. 10 signs 11879 con 10 cartelitos 11879 / avec 10 étiquettes 11879

Schilder, 10er Set / signs, 10 pcs. / set de 10 cartelitos / set de 10 étiquettes

	cm	
11879	7,7 x 5,2	
12879	5,0 x 3,0	



10 Schilderhalter „FLEX CLIP“

10 sign holders
10 clips
10 porte-étiquettes



Durch die bewegliche Verbindung der Klemme und Schilderhalterung ein extrem flexibler Cliphalter!
multi angle ticket clip / inclinable con pinza / inclinable avec pince

	→ cm	Farbe / Colour
71472	9,5	White
71474	9,5	Black

Schilder, 10er Set / signs, 10 pcs. / set de 10 cartelitos / set de 10 étiquettes

	cm	pcs.
11879	7,7 x 5,2	10
12879	5,0 x 3,0	10



10 Beschriftungsclips, inkl. 10 Schilder

10 sign holders, with 10 signs
10 soportes + 10 cartelitos
10 supports + 10 étiquettes



	cm	Farbe / Colour
71482	6 x 2,7	White
71483	6 x 2,7	Black

Schilder, 10er Set / signs, 10 pcs. / set de 10 cartelitos / set de 10 étiquettes

	cm	
11879	7,7 x 5,2	
12879	5,0 x 3,0	



Tischaufsteller 2er Set

table stands, 2 pcs.
caballetes de mesa, set de 2
chevalets de table, set de 2



	cm	↑ cm	
00017	5,5 x 5	3,5	reserviert
00013	5,5 x 5	3,5	reserved
00572	5,5 x 5	3,5	smoking

MENU HOLDER



71425

71427

Kartenhalter, 4er Set

table stands, 4 pcs.
portatarjetas, set de 4
porte-cartes, set de 4



inkl. 30 Beschriftungskarten ca. 10 x 8 cm (15x weiß, 15x schwarz)

incl. 30 labels 10 x 8 cm (15x white + 15x black)

incl. 30 tarjetas 10 x 8 cm (15x blanco + 15x negro)

incl. 30 étiquettes 10 x 8 cm (15x blanc + 15x noir)

	Ø cm	↑ cm	Farbe / Colour	pcs.
71425	3	10	Marmor weiß / marble white	4
71427	3	10	Marmor grau / marble grey	4



71426

71428

Kartenhalter, 4er Set

table stands, 4 pcs.
portatarjetas, set de 4
porte-cartes, set de 4



inkl. 30 Beschriftungskarten ca. 10 x 8 cm (15x weiß, 15x schwarz)

incl. 30 labels 10 x 8 cm (15x white + 15x black)

incl. 30 tarjetas 10 x 8 cm (15x blanco + 15x negro)

incl. 30 étiquettes 10 x 8 cm (15x blanc + 15x noir)

	cm	↑ cm	Farbe / Colour	pcs.
71426	3,5 x 3,5	10	Marmor weiß / marble white	4
71428	3,5 x 3,5	10	Marmor grau / marble grey	4



Beschriftungsetiketten

labeling labels
etiquetas
étiquettes



12 Bögen mit je 6 Motiven, selbstklebend, mit wasserlöslichem Stift beschreibbar

12 sheets includes 6 self-adhesive and removable labels, use regular chalkboard markers and wipe clean with a clamp cloth

12 hojas, cada una con 6 motivos autoadhesivos, se pueden marcar con un rotulador lavable con agua

12 feuilles chacune avec 6 motifs autoadhésifs, on peut écrire avec un stylo lavable à l'eau

	cm	Farbe / Colour
00069	8,0 x 4,6	■



Kreide-Marker, Stärke 2 mm, 2er Set

chalk marker, 2 pcs.
rotulador de tiza, set de 2
marqueur a la craie liquide, set de 2



Zum Gestalten und Beschriften von Tafeln, Glas und fast allen geschlossenen Oberflächen, deckende Flüssigkreide auf Wasserbasis, feucht abwischbar

For decorating and writing on boards, glass and almost all non-porous surfaces, opaque water-based liquid chalk, wet-wipeable

Rotuladores para pizarra de tiza líquida para decorar y escribir sobre pizarras, cristales y casi todas las superficies no porosas. Tizi líquida opaca al agua que se pueda borrar con un trapo

Pour décorations et inscriptions sur tableaux, verre et presque toutes les surfaces non poreuses, craie liquide opaque à base d'eau, effaçable avec un chiffon humide

	Ø cm	↑ cm	Farbe / Colour	pcs.
71490	1	13	■	2
71491	1	13	■	2

NEW

TWO IN ONE



Fondue

13 tlg. Set
13 pcs. set

Feuerzange



2,2 ltr.

65060

65061

6 Stk.
6 pcs.

65062

Fondue und Feuerzangenbowl-Set „TWO IN ONE“

fondue and fire punch bowl set
set para fondue o ponche caliente
service à fondue et à punchEDELSTAHL
STAINLESS
INOX
18/8PP
POLYPROPYLEN

13-teiliges Set aus Edelstahl bestehend aus:

1 Topf, 1 Rechaud, 1 Spritzschutz, 1 Untersetzer, 1 Schöpfkelle, 1 Feuerzange,
1 Pastenbrenner, 6 Fonduegabeln

13-piece stainless steel set consisting of:

1 pot, 1 rechaud, 1 splash guard, 1 coaster, 1 ladle, 1 fire tongs,
1 paste burner, 6 fondue forks

set de 13 piezas de acero inoxidable compuesto por:

1 olla, 1 rechaud, 1 protector contra salpicaduras, 1 trébede, 1 cazo,
1 pinza para el fuego, 1 quemador de pasta, 6 tenedores de fondue

set de 13 pièces en acier inox comprenant:

1 marmite, 1 rechaud, 1 pare-éclaboussures, 1 dessous de plat, 1 louche, 1 pince à feu,
1 brûleur à pâte, 6 fourchettes à fondue

	Ø cm	↑ cm	ltr.
65060	22	23	2,2

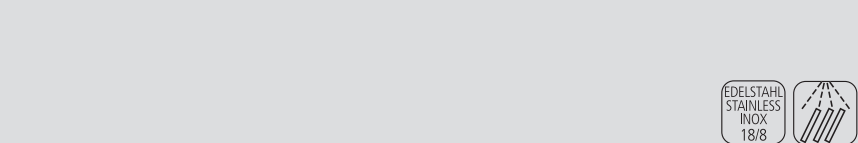
Brennpastenbehälter zu 65060 / fuel paste container for 65060 / recipiente para pasta de
combustible para 65060 / récipient pour pâte à combustible pour 65060EDELSTAHL
STAINLESS
INOX
18/8

	cm	↑ cm	fits to
65061	26 x 12	10	65060

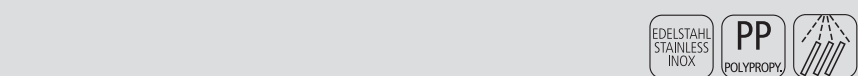

Gabelset zu 65060 / fork set for 65060 / set de tenedores para 65060 / set de fourchettes pour 65060

EDELSTAHL
STAINLESS
INOXPP
POLYPROPYLEN

	cm	→ cm	pcs.	fits to
65062	24	Griff / handle 8	6	65060





Körbe

baskets
cestas
corbeilles

SUPERSTRONG



GN 1/1 Korb „SUPERSTRONG“

GN 1/1 basket
GN 1/1 cesta
GN 1/1 corbeille



	cm	↑ cm	GN	Farbe / Colour
50640	53 x 32,5	6,5	1/1	
50641	53 x 32,5	10,0	1/1	
50642	53 x 32,5	15,0	1/1	
50643	53 x 32,5	6,5	1/1	
50644	53 x 32,5	10,0	1/1	
50645	53 x 32,5	15,0	1/1	

GN Kuppelhaube / GN cover / GN cúpula / GN cloche bombée

	cm	↑ cm	GN
11027	54 x 33	20	1/1

GN Abdeckhaube / GN cover / GN cubierta / GN cloche

	cm	↑ cm	GN
11042	53 x 32,5	9,5	1/1

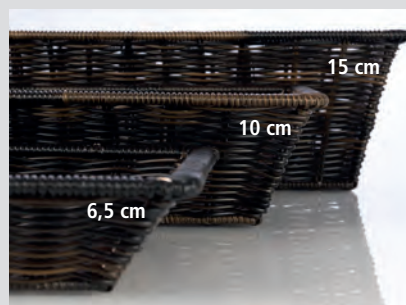

PROFI LINE



50714

50901

50902

Korb "PROFI LINE"
basket baker size
cesta tamaño panaderia
corbeille dimensions „boul-pâte“



	cm	↑ cm	Farbe / Colour
50714	30 x 20	5	
50900	40 x 20	5	
50901	40 x 20	5	
50902	40 x 20	5	
50903	40 x 20	5	



50906

50907

50712

Korb "PROFI LINE"
basket baker size
cesta tamaño panaderia
corbeille dimensions „boul-pâte“



	cm	↑ cm	Farbe / Colour
50905	40 x 30	5	
50906	40 x 30	5	
50907	40 x 30	5	
50908	40 x 30	5	
	cm	↑ cm	Farbe / Colour
50710	40 x 30	10	
50711	40 x 30	10	
50713	40 x 30	10	
50712	40 x 30	10	



50911

50913

Korb "PROFI LINE"
basket baker size
cesta tamaño panaderia
corbeille dimensions „boul-pâte“



	cm	↑ cm	Farbe / Colour
50910	60 x 20	5	
50911	60 x 20	5	
50912	60 x 20	5	
50913	60 x 20	5	

BASKETS

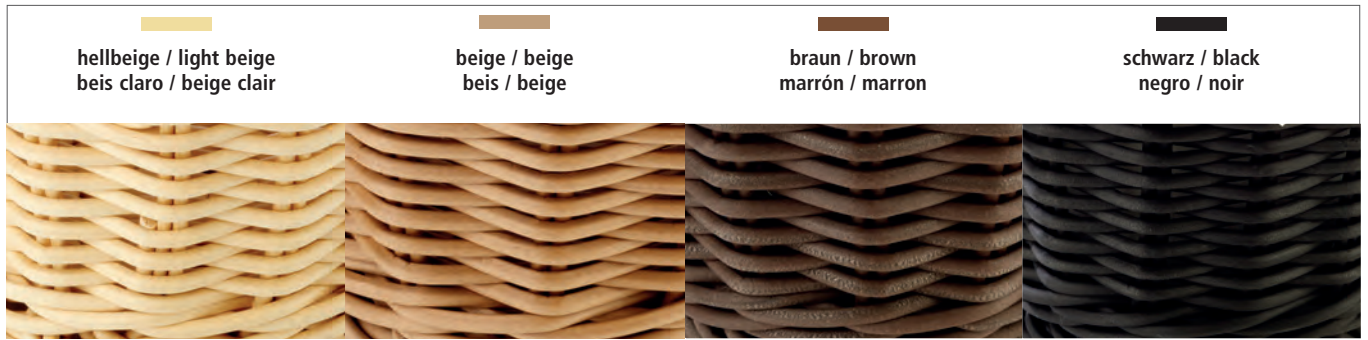

hellbeige / light beige
beis claro / beige clair

beige / beige
beis / beige

braun / brown
marrón / marron

schwarz / black
negro / noir



50916

50917

50918

Korb "PROFI LINE"

basket baker size
cesta tamaño panaderia
corbeille dimensions „boul-pâte"



	cm	↑ cm	Farbe / Colour
50915	60 x 40	5	hellbeige
50916	60 x 40	5	beige
50917	60 x 40	5	braun
50918	60 x 40	5	schwarz



50720

50723

GN 1/1 Korb „PROFI LINE"

GN 1/1 basket
GN 1/1 cesta
GN 1/1 corbeille



	cm	↑ cm	Farbe / Colour
50720	53 x 32,5	10	hellbeige
50721	53 x 32,5	10	beige
50723	53 x 32,5	10	braun
50722	53 x 32,5	10	schwarz



50700

50701

50707

Korb, rechteckig „PROFI LINE"

basket, rectangular
cesta, rectangular
corbeille, rectangulaire



	cm	↑ cm	Farbe / Colour
50700	26,5 x 19	7	hellbeige
50701	26,5 x 19	7	beige
50703	26,5 x 19	7	braun
50702	26,5 x 19	7	schwarz

	cm	↑ cm	Farbe / Colour
50705	31 x 21	9	hellbeige
50706	31 x 21	9	beige
50708	31 x 21	9	braun
50707	31 x 21	9	schwarz



Brötchenschütte „PROFI LINE“

roll / bun basket
cesta para bollos
corbeille à petits pains



	cm	↑ cm
50510	60 x 40	60



Stangenbrotkorb „PROFI LINE“

baguette basket
cesta de baguette
corbeille à baguettes



	Ø cm	↑ cm	Farbe / Colour
50500	28 / 30	38	
50501	28 / 30	38	

50500

50501

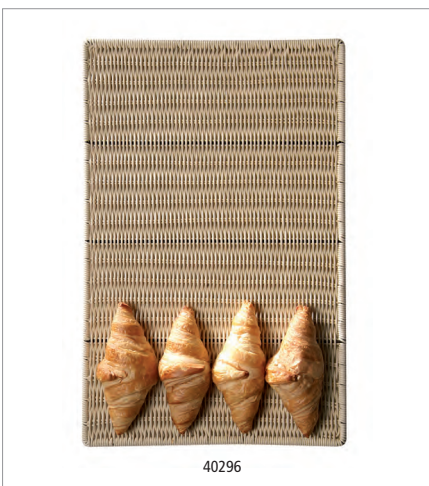

Auslage Tablett flach „PROFI LINE“

display tray flat, baker size
bandeja de presentación, tamaño panadería
plateau de présentation, dimensions „boul-pâte“



	cm	↑ cm
40296	40 x 30	1
40297	60 x 40	1

40296

BASKETS



Korb, rund „PROFI LINE“

basket, round
cesta redonda
corbeille ronde



	∅ cm	↑ cm
50210	37	9
50215	42	12



Korb, rund „PROFI LINE“

basket, round
cesta redonda
corbeille ronde



	∅ cm	↑ cm
50205	31 / 37	12 / 6



Korbschütte, rund „PROFI LINE“

basket, round
cesta redonda
corbeille ronde



	∅ cm	↑ cm
50100	36,5	12,0
50105	42,0	18,5
50110	46,0	18,5



Systemkorb, gestäbt „PROFI LINE“

basket
cesta
corbeille



	cm	↑ cm
50300	30 x 40	27 / 16
50305	45 x 40	27 / 16
50310	60 x 40	27 / 16



Systemkorb „PROFI LINE“

basket
cesta
corbeille



	cm	↑ cm
50400	40 x 50	25 / 14



Trenner „PROFI LINE“

divider
divisor
paroi de séparation



	↑ cm	→ cm
50315	26 / 15	38



Baguette Korb, oval „PROFI LINE“

baguette basket, oval
cesta de baguette, oval
corbeille à baguettes, ovale



	cm	↑ cm	Farbe / Colour
50805	28 x 16	8	
50806	28 x 16	8	
50808	28 x 16	8	
50807	28 x 16	8	

	cm	↑ cm	Farbe / Colour
50823	40 x 16	8	



Korb, oval „PROFI LINE“

basket, oval
cesta oval
corbeille ovale



	cm	↑ cm	Farbe / Colour
50800	25 x 19	6,5	
50801	25 x 19	6,5	
50803	25 x 19	6,5	
50802	25 x 19	6,5	

	cm	↑ cm	Farbe / Colour
50815	32 x 23	7	
50816	32 x 23	7	
50818	32 x 23	7	
50817	32 x 23	7	



Korb, rund „PROFI LINE“

basket, round
cesta redonda
corbeille ronde



	Ø cm	↑ cm	Farbe / Colour
50600	16	8	
50601	16	8	
50603	16	8	
50602	16	8	

	Ø cm	↑ cm	Farbe / Colour
50605	20	8	
50606	20	8	
50608	20	8	
50607	20	8	

	Ø cm	↑ cm	Farbe / Colour
50610	29	7	
50611	29	7	
50613	29	7	
50612	29	7	

BASKETS



Korb, oval „PROFI LINE“

basket, oval
cesta, oval
corbeille, ovale



	cm	↑ cm	Farbe / Colour
50624	19 x 12	6	
50625	19 x 12	6	
50627	19 x 12	6	
50626	19 x 12	6	



Korb, rechteckig „PROFI LINE“

basket, rectangular
cesta rectangular
corbeille rectangulaire



	cm	↑ cm	Farbe / Colour
50632	17 x 11	9	
50633	17 x 11	9	
50635	17 x 11	9	
50634	17 x 11	9	

	cm	↑ cm	Farbe / Colour
50628	19 x 13	6	
50629	19 x 13	6	
50631	19 x 13	6	
50630	19 x 13	6	



Korb, rund „PROFI LINE“

basket, round
cesta, redonda
corbeille, ronde



	Ø cm	↑ cm	Farbe / Colour
50620	13	10	
50621	13	10	
50623	13	10	
50622	13	10	

GN LINE



2 Höhen - 6,5 und 10 cm
2 heights - 6,5 and 10 cm



40293
GN 1/1 - 10 cm



40292
GN 1/2 - 10 cm
40225
GN 1/4 - 6,5 cm

Korb „GN LINE“

GN basket
GN cesta
GN corbeille



stabile Ausführung mit Edelstahldraht im Rand zur Stabilisierung
very solid with stainless steel wire frame to stabilize the basket
muy resistente con refuerzo de alambre inox
très résistante avec son fil de renfort inox

	cm	↑ cm	GN	Farbe / Colour
40291	53,0 x 32,5	6,5	1/1	
40290	32,5 x 26,5	6,5	1/2	
40223	32,5 x 17,6	6,5	1/3	
40225	26,5 x 16,2	6,5	1/4	
40227	17,6 x 16,2	6,5	1/6	
40229	32,5 x 35,4	6,5	2/3	

	cm	↑ cm	GN	Farbe / Colour
40293	53,0 x 32,5	10,0	1/1	
40292	32,5 x 26,5	10,0	1/2	
40243	32,5 x 17,6	10,0	1/3	
40245	26,5 x 16,2	10,0	1/4	
40247	17,6 x 16,2	10,0	1/6	
40249	32,5 x 35,4	10,0	2/3	



GN 1/1

GN 1/1 Besteckbehälter

GN 1/1 dispenser GN
GN 1/1 dispensador de cubiertos
GN 1/1 bac à couverts



in Handarbeit geflochten, 4 Mulden, Kunststoff-Geflecht, Drahtgestell, braun-schwarz
wickerwork, 4 compartments, with reinforced chromed wire structure, brown-black
cesta trensada a mano, 4 compartimentos, de plástico, con bastidor cromado reforzado, marrón oscuro
corbeille tressée à main, 4 compartiments, en plastique, cadre acier chromé renforcé, couleur marron foncé

	cm	↑ cm	GN	Farbe / Colour
11966	53 x 32,5	9	1/1	

GN LINE

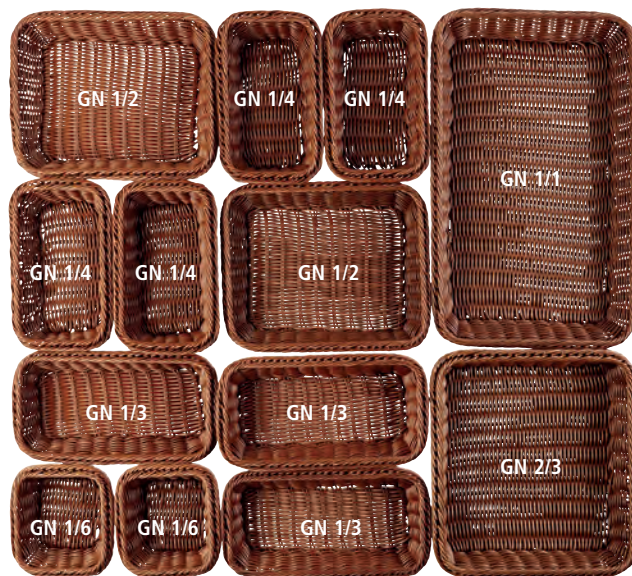
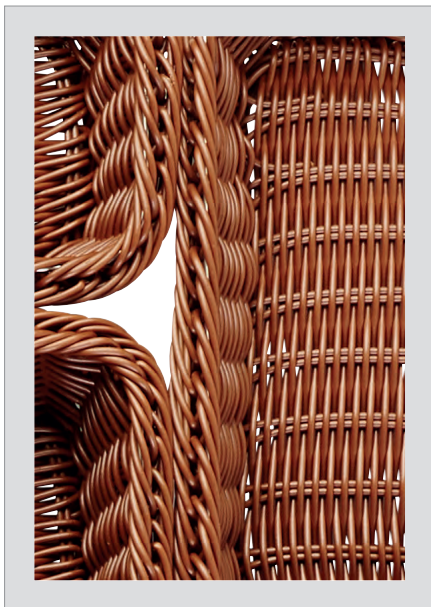

Korb „GN LINE“

GN basket
GN cesta
GN corbeille



stabile Ausführung mit Edelstahldraht im Rand zur Stabilisierung
very solid with stainless steel wire frame to stabilize the basket
muy resistente con refuerzo de alambre inox
très résistante avec son fil de renfort inox

	cm	↑ cm	GN	Farbe / Colour
40220	53,0 x 32,5	6,5	1/1	Yellow
40222	32,5 x 26,5	6,5	1/2	Yellow
40224	32,5 x 17,6	6,5	1/3	Yellow
40226	26,5 x 16,2	6,5	1/4	Yellow
40228	17,6 x 16,2	6,5	1/6	Yellow
40230	32,5 x 35,4	6,5	2/3	Yellow

	cm	↑ cm	GN	Farbe / Colour
40240	53,0 x 32,5	10	1/1	Yellow
40242	32,5 x 26,5	10	1/2	Yellow
40244	32,5 x 17,6	10	1/3	Yellow
40246	26,5 x 16,2	10	1/4	Yellow
40248	17,6 x 16,2	10	1/6	Yellow
40250	32,5 x 35,4	10	2/3	Yellow

	cm	↑ cm	GN	Farbe / Colour
40260	53,0 x 32,5	6,5	1/1	Brown
40262	32,5 x 26,5	6,5	1/2	Brown
40263	32,5 x 17,6	6,5	1/3	Brown
40264	26,5 x 16,2	6,5	1/4	Brown
40266	17,6 x 16,2	6,5	1/6	Brown
40268	32,5 x 35,4	6,5	2/3	Brown

	cm	↑ cm	GN	Farbe / Colour
40270	53,0 x 32,5	10	1/1	Brown
40272	32,5 x 26,5	10	1/2	Brown
40274	32,5 x 17,6	10	1/3	Brown
40276	26,5 x 16,2	10	1/4	Brown
40278	17,6 x 16,2	10	1/6	Brown
40280	32,5 x 35,4	10	2/3	Brown

ECONOMIC



Tisch- und Buffetkorb, rund „ECONOMIC“
buffet basket, round
cesta de buffet, redonda
corbeille de buffet, ronde



	Ø cm	↑ cm	Farbe / Colour
40132	19,0	9,5	
40135	25,5	8,5	
40144	39,0	10,0	
40191	19,0	9,5	
40192	25,5	8,5	



Tisch- und Buffetkorb, oval „ECONOMIC“
buffet basket, oval
cesta de buffet, oval
corbeille de buffet, ovale



	cm	↑ cm	Farbe / Colour
40137	23,0 x 17	8,0	
40139	28,5 x 17	8,5	
40193	23,0 x 17	8,0	
40194	28,5 x 17	8,5	



stapelbar
stackable



Tisch- und Buffetkorb, eckig „ECONOMIC“
buffet basket, rectangular
cesta de buffet, rectangular
corbeille de buffet, rectangulaire



	cm	↑ cm	Farbe / Colour
40140	23,0 x 17	8	
40159	31,5 x 22	8,5	
40195	23,0 x 17	8	
40196	31,5 x 22	8,5	



GN Buffetkorb „ECONOMIC“
GN basket
GN cesta
GN corbeille



	cm	↑ cm	GN	Farbe / Colour
40148	53 x 32,5	8	1/1	



GN Buffetkorb „ECONOMIC“
GN basket
GN cesta
GN corbeille



	cm	↑ cm	GN	Farbe / Colour
40152	32,5 x 26,5	8	1/2	

BASKETS



Buffetkorb „ECONOMIC“

buffet basket
cesta de buffet
corbeille de buffet



stabile Ausführung mit Edelstahldraht im Rand zur Stabilisierung

very solid with stainless steel wire frame to stabilize the basket

muy resistente con refuerzo de alambre inox

très résistante avec son fil de renfort inox

	cm	↑ cm	GN
40129	53 x 32,5	15,5	1/1

GN Kuppelhaube / GN cover / GN cúpula / GN cloche bombée

	cm	↑ cm
11027	54 x 33	20



Buffetkorb „ECONOMIC“

buffet basket
cesta de buffet
corbeille de buffet



stabile Ausführung mit Edelstahldraht im Rand zur Stabilisierung

very solid with stainless steel wire frame to stabilize the basket

muy resistente con refuerzo de alambre inox

très résistante avec son fil de renfort inox

	cm	↑ cm
40153	45 x 42	17 / 24



Buffetkorb, rund „ECONOMIC“

buffet basket, round
cesta de buffet, redonda
corbeille de buffet ronde



stabile Ausführung mit Edelstahldraht im Rand zur Stabilisierung

very solid with stainless steel wire frame to stabilize the basket

muy resistente con refuerzo de alambre inox

très résistante avec son fil de renfort inox

	Ø cm	↑ cm	Farbe / Colour
40149	40	12,5	
40295	40	12,5	

Rolltophaube / rolltop cover / campana abatible / cloche basculante

	Ø cm	↑ cm	
18388	38	20	mit verchromtem Kugelgriff with chrome plated handle con pomo cromado / avec bouton chromé
18387	38	20	mit vergoldetem Kugelgriff / gold plated handle pomo dorado / bouton doré
18389	38	20	mit verchromtem Designergriff / with chrome plated designer handle



Buffetkorb „ECONOMIC“

buffet basket
cesta de buffet
corbeille buffet



in Handarbeit geflochten, stabile Ausführung, Edelstahl Fixierungsrahmen, zur Rutschsicherung, ohne Haube

wickerwork, stainless steel fix the cover, without cover

cesta trensada a mano, con marco cromado patentado para fijar y encajar la campana (se entrega sin la campana)

corbeille tressée main, cadre fil acier inoxydable pour fixer la cloche (livré sans la cloche)

	cm	↑ cm	Farbe / Colour
40150	56,5 x 36	10	
40294	56,5 x 36	10	

GN 1/1 Rolltop-Haube / GN 1/1 rolltop cover / GN 1/1 campana abatible
GN 1/1 cloche basculante

	cm	↑ cm	GN	
11008	53 x 32,5	19	1/1	vergoldeter Griff / gold plated handle pomo dorado / bouton doré
11010	53 x 32,5	19	1/1	verchromter Griff / chrome plated handle pomo cromado / bouton chromé
11018	53 x 32,5	17	1/1	mit verchromtem Designergriff with chrome plated designer handle



GN Kuppelhaube

GN cover
GN cúpula
GN cloche bombée



glasklarer Kunststoff, Griff aus Zinkdruckguss

crystal clear plastic, die-cast zinc knob

plástico transparente, asa de zinc fundido a presión

plastique transparente, poignée en zinc moulé sous pression

	cm	↑ cm	GN	
11021	33 x 28	17	1/2	geschlossen / totally closed cerrada / tolement fermée
11022	33 x 28	17	1/2	mit Front-Ausschnitt / one long side cut out gran apertura frontal / grande ouverture frontale
11026	54 x 33	20	1/1	geschlossen / totally closed cerrada / tolement fermée
11027	54 x 33	20	1/1	mit Front-Ausschnitt / one long side cut out gran apertura frontal / grande ouverture frontale
11028	54 x 33	20	1/1	mit seitlichem Ausschnitt one small side cut out pequeña apertura lateral / petite ouverture latérale



Eierkorb „PROFI LINE“

egg basket
cesta de huevos
panier à oeufs



mit Edelstahldraht im Rand
with stainless steel wire in the rim

für ca. 20 Eier, hält den Inhalt durch das Stoff-Futter lange warm

for around 20 eggs, keeps the eggs warm for a long time thanks to the fabric lining

para unos 20 huevos, mantiene los huevos calientes mucho tiempo gracias al forro de tela

pour env. 20 oeufs, garde les oeufs au chaud longtemps grâce à la doublure en tissu

	Ø cm	↑ cm	Farbe / Colour
40299	26	17	
30299	26	17	

stabile Vollweide
willow, stable

BASKETS



Buffetgestell „DOPPELDECKER“ für GN

buffet frame for GN
estructura para buffet para GN
support buffet pour GN



2-teilig, einfach zusammensetzbar, Etagen-Abstand ca. 26 cm, platzsparend, stabile Ausführung
2 pcs., easy to assemble, distance between the tiers approx. 26 cm, space-saving, robust
2 pzas, fácil de montar, distancia entre pisos aprox. 26 cm, robusto
2 pcs, assemblage facile, distance entre niveaux approx. 26 cm, robuste

	cm	↑ cm	fits to GN
11555	50 x 34	37,5	1/1
11553	29 x 27	35,0	1/2



Baguettekorb „ECONOMIC“

baguette basket
cesta para baguette
corbeille pour baguettes



stabile Ausführung mit Edelstahldraht im Rand zur Stabilisierung
very solid with stainless steel wire frame to stabilize the basket
muy resistente con refuerzo de alambre inox
très résistante avec son fil de renfort inox

	Ø cm	↑ cm	Farbe / Colour
40198	35	24 / 42	



Besteckkorb „ECONOMIC“

cutlery dispenser
dispensador de cubiertos
corbeille à couverts



4 Fächer (3 kleine und 1 großes) / 4 compartments (3 small and 1 large) /
4 compartimentos (3 pequeños y 1 grande) / 4 compartiments (3 petits et 1 grand)

	cm	↑ cm	Farbe / Colour
40179	26 x 18	15	
40182	26 x 18	15	





Brot- und Obstkorb „WICKER LOOK“

basket for bread or fruits
cesta para pan o fruta
corbeille à pain ou à fruits



	Ø cm	↑ cm	Farbe / Colour
40214	20	6,5	■
40216	23 x 17	6,5	■

	cm	↑ cm	Farbe / Colour
40211	39,5 x 29,5	10	■
40212	39,5 x 29,5	10	■
40210	39,5 x 29,5	10	■



Besteckkorb „ECONOMIC“

cutlery dispenser
dispensador de cubiertos
corbeille à couverts



in Handarbeit geflochten
wickerwork
trensado a mano
tressage à main

	Ø cm	↑ cm	Farbe / Colour
40130	12	15	■
40007	12	15	■
40012	12	15	■
40013	12	15	■



Besteckkorb „ECONOMIC“

cutlery dispenser
dispensador de cubiertos
corbeille à couverts



in Handarbeit geflochten
wickerwork
trensado a mano
tressage à main

	cm	↑ cm	Farbe / Colour
40131	27 x 10	4,5	■
40009	27 x 10	4,5	■
40010	27 x 10	4,5	■
40011	27 x 10	4,5	■

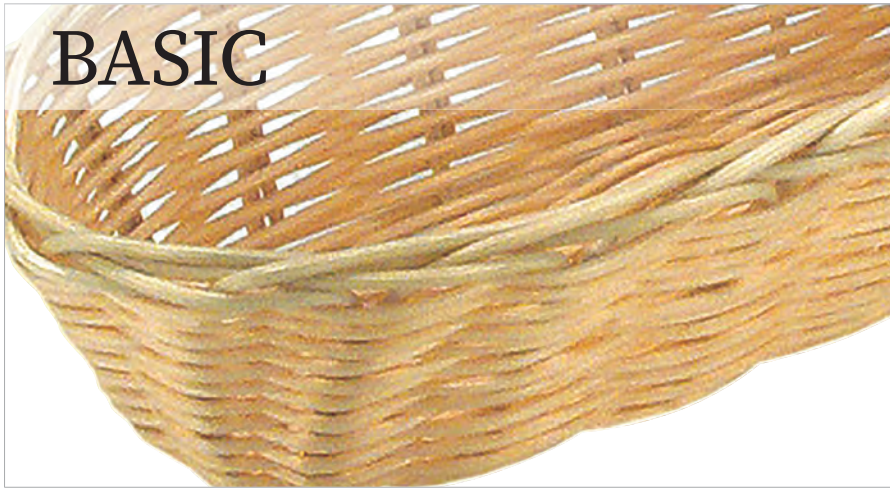

- in Handarbeit geflochten, einfache und leichte Ausführung
- wickerwork, simple and light version
- ligera, trensada a mano
- tressé à main, version légère



Brot- und Obstkorb oval „BASIC“

basket for bread or fruits
cesta para pan o fruta
corbeille à pain ou à fruits



	cm	↑ cm
30279	18 x 12	7
30280	23 x 15	6



Brot- und Obstkorb oval „BASIC“

basket for bread or fruits
cesta para pan o fruta
corbeille à pain ou à fruits



	cm	↑ cm
30282	21 x 10	6
30284	36 x 15	7



Brot- und Obstkorb rund „BASIC“

basket for bread or fruits
cesta para pan o fruta
corbeille à pain ou à fruits



	Ø cm	↑ cm
30281	20	7
30285	25	7



Tisch- und Buffetkorb rechteckig „BASIC“

buffet basket
cesta de buffet
corbeille de buffet



	cm	↑ cm
30286	30 x 22	7
30288	41 x 29	7
30283	22 x 15	6



Brot- und Obstkorb quadratisch „BASIC“

basket for bread or fruits
cesta para pan o fruta
corbeille à pain ou à fruits



	cm	↑ cm
30287	24 x 24	6

Brottasche

Umgekrempelt kann die Höhe individuell gestaltet werden!



30440



30451

rund

Brottasche

bread basket
panera
corbeille



70% Naturfaser und 30% Kunstharz
70% natural fibre and 30% synthetic resin
70% fibra natural y 30% resina sintética
70% de fibres naturelles et 30% de résine synthétique

	Ø cm	↑ cm	Farbe / Colour
30440	17	11	■
30450	20	13	■
30442	24	24	■
30443	30	22	■
30441	17	11	■
30451	20	13	■
30445	24	24	■
30446	30	22	■



30444



30447

oval

Brottasche

bread basket
panera
corbeille



70% Naturfaser und 30% Kunstharz
70% natural fibre and 30% synthetic resin
70% fibra natural y 30% resina sintética
70% de fibres naturelles et 30% de résine synthétique

	cm	↑ cm	Farbe / Colour
30444	30 x 20	18	■
30447	30 x 20	18	■

umgekrempelt kann die Höhe individuell gestaltet werden
adjustable height by turning the edge upside down
altura ajustable girando el borde al revés
hauteur ajustable en tournant le bord à l'envers

BASKETS



Brottasche bread basket panera corbeille



70% Naturfaser und 30% Kunstharz
70% natural fibre and 30% synthetic resin
70% fibra natural y 30% resina sintética
70% de fibres naturelles et 30% de résine synthétique

	cm	↑ cm	Farbe / Colour
30355	12 x 11,5	11,5	■
30356	12 x 11,5	11,5	■



umgekrempelt kann die Höhe individuell gestaltet werden
adjustable height by turning the edge upside down
altura ajustable girando el borde al revés
hauteur ajustable en tournant le bord à l'envers



Brottasche bread basket panera corbeille



schmutzabweisende Kunstfaser, 30°C waschbar
dirt-repellent synthetic fibre, washable 30°C
fibra sintética repelente a la suciedad, lavable a 30°C
fibre synthétique anti-salissante, lavable à 30°C

	Ø cm	↑ cm	Farbe / Colour
30345	17	11,5	■
30346	20	13,5	■



Brottasche bread basket panera corbeille



schmutzabweisende Kunstfaser, 30°C waschbar
dirt-repellent synthetic fibre, washable 30°C
fibra sintética repelente a la suciedad, lavable a 30°C
fibre synthétique anti-salissante, lavable à 30°C

	cm	↑ cm	Farbe / Colour
30347	19 x 11	10,5	■
30348	24 x 16	10,5	■



Präsentationsmöglichkeit
presentation example



30350 rund / round

30371 oval

Brottasche

bread basket
panera
corbeille à pain en toile



Baumwolle, umgekrempelt kann die Höhe individuell gestaltet werden, maschinenwaschbar bis 30°C, rund oder oval
cotton, adjustable height, mashine-washable 30°C, round or oval
algodón, altura ajustable, lavable a máquina 30°C, redondo u oval
coton, hauteur ajustable, lavable en machine maxi 30°C, rond ou ovale

	Ø cm	↑ cm	Farbe / Colour
30340	17	11	
30350	20	12	
30341	17	11	
30351	20	12	
30360	20 x 15	10	
30370	25 x 18	12	
30361	20 x 15	10	
30371	25 x 18	12	



mit Zugverschluss

Das Wärmekissen einfach in der Mikrowelle erhitzen (90 Sekunden / 500 Watt)

maschinenwaschbar bis 30°C (außer Kissen)

Brottasche mit Wärmekissen

bread basket with stones pillow
panera con cojín
corbeille à pain en toile avec coussin chauffant



Baumwolle, Keramik-Kugeln, maschinenwaschbar bis 30°C
cotton, ceramic stones, mashine-washable 30°C
algodón, bolas de cerámica, lavable a máquina 30°C
coton, billes de céramiques, lavable en machine maxi 30°C

	Ø cm	↑ cm	Farbe / Colour
30380	19	23	
30390	19	23	

Wärmekissen / stones pillow / cojín de piedrecillas a calentar / coussin de petites pierres, à chauffer

	Ø cm	↑ cm
30385	19	1,5

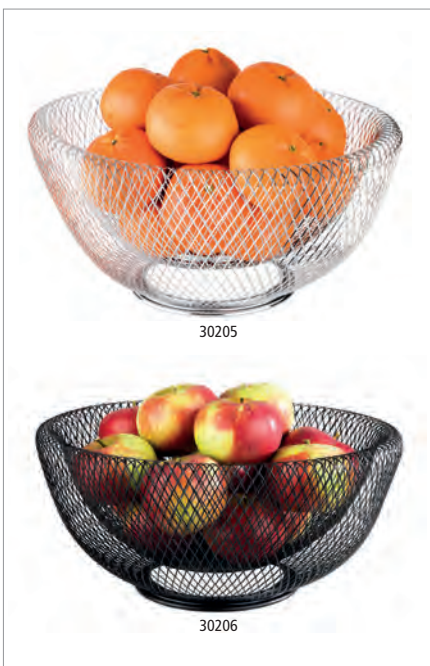

30205

30206

Brot- und Obstkorb „WIRE“

wire basket
cesta para pan o fruta
corbeille pour pain ou fruits



	Ø cm	↑ cm	Farbe / Colour
30205	31	14	metal chrome
30206	31	14	metal black

BASKETS

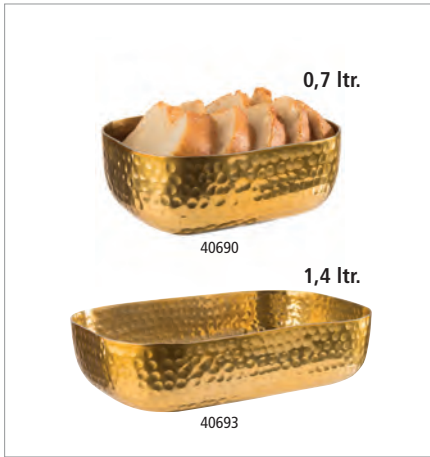

Schale

bowl
cuenco
bol



gehämmerte Oberfläche
hammered surface
superficie martillada
surface martelée

	cm	↑ cm	ltr.	Farbe / Colour	
40690	15,5 x 12,0	5,5	0,7		gold look
40693	23,0 x 15,5	6,0	1,4		gold look

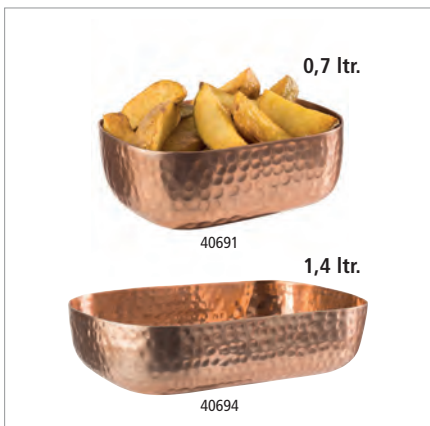

Schale

bowl
cuenco
bol



gehämmerte Oberfläche
hammered surface
superficie martillada
surface martelée

	cm	↑ cm	ltr.	Farbe / Colour	
40691	15,5 x 12,0	5,5	0,7		copper look
40694	23,0 x 15,5	6,0	1,4		copper look



Schale

bowl
cuenco
bol



gehämmerte Oberfläche
hammered surface
superficie martillada
surface martelée

	cm	↑ cm	ltr.	Farbe / Colour	
40692	15,5 x 12,0	5,5	0,7		gunmetal-look
40695	23,0 x 15,5	6,0	1,4		gunmetal-look



Servierkorb „BURGER & FRIES“

serving basket
cesta para servir
corbeille de service



Servierkorb aus Metall mit 2 Haltern für Dipschälchen

metal serving basket with 2 holders for dip bowls

cesta de metal para servir con 2 soportes para cuencos para dip

corbeille de service en métal avec 2 supports pour ramequins

	cm	↑ cm		
40604	39,5 x 20	11		

passende Schälchen / fitting bowls / cuencos adecuados / bols apropiés



	Ø cm	↑ cm	ltr.	VE / unit
83781	7	3,7	0,05	24



Korb „URBAN“

basket
cesta
corbeille



	Ø cm	↑ cm	Farbe / Colour
30410	17	7,0	■
30411	20	8,5	■



Korb „URBAN“

basket
cesta
corbeille



	cm	↑ cm	Farbe / Colour
30412	21 x 10	7	■
30413	30 x 14	12	■



Korb „URBAN“

basket
cesta
corbeille



	cm	↑ cm	Farbe / Colour
30337	29 x 16	7	■



GN Korb „URBAN“

GN basket
GN cesta
GN corbeille



	cm	↑ cm	GN	Farbe / Colour
30414	53,0 x 32,5	7,5	1/1	■
30415	32,5 x 26,5	7,5	1/2	■
30416	53,0 x 16,2	7,5	2/4	■

GN Abdeckhaube / GN cover / GN cubierta / GN cloche

	cm	↑ cm	GN	
11044	53 x 16,2	10,5	2/4	
11042	53 x 32,5	9,5	1/1	ohne Abbildung
11022	33 x 28,0	17,0	1/2	ohne Abbildung
11027	54 x 33,0	20,0	1/1	

BASKETS



Korb „SVART“
basket
cesta
corbeille

Black
is
beautiful



	Ø cm	↑ cm	Farbe / Colour
30420	17,5	8	■
30421	20,0	8	■



Korb „SVART“
basket
cesta
corbeille

Black
is
beautiful



	cm	↑ cm	Farbe / Colour
30422	20 x 15	8	■
30423	24 x 19	8	■

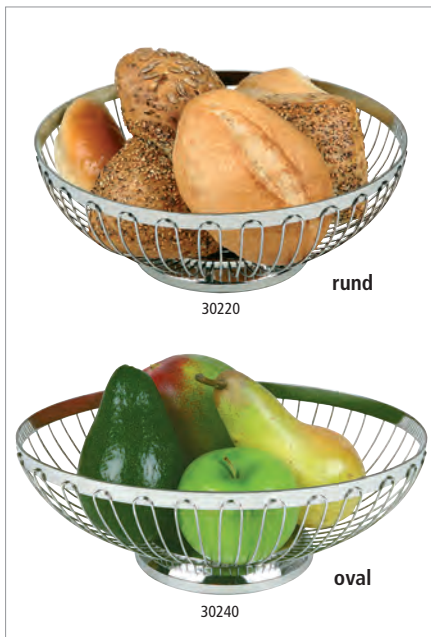

Brot- und Obstkorb
basket for bread or fruits
cesta para pan o fruta
corbeille à pain ou à fruits



hochglanzpoliert
mirror polished finish
acabado pulido brillante
brillant

	Ø cm	↑ cm
30200	17,5	7,0
30220	20,5	8,5
30230	25,5	9,5

	cm	↑ cm
30210	20 x 15	7,0
30240	24 x 19	8,5
30250	28 x 21	9,5



Obstkorb
basket for fruits
cesta para fruta
corbeille à fruits



hochglanzpoliert
mirror polished finish
acabado pulido brillante
brillant

	Ø cm	↑ cm
30270	21,5	20,5



Lunchbag, 2er Set

lunch bag, 2 pcs.
bolsa de almuerzo, set de 2
sac à lunch, set de 2

70%
NATURFASER
30%
KUNSTHARZ



70% Naturfaser und 30% Kunstharz
70% natural fibre and 30% synthetic resin
70% fibra natural y 30% resina sintética
70% de fibres naturelles et 30% de résine synthétique

	cm	↑ cm
30357	16 x 10	32
30358	25 x 15	30



mit Klettverschluss
with velcro fastener
con cierre de velcro
avec fermeture velcro



Brot- und Obstkorb

basket for bread or fruits
cesta para pan o fruta
corbeille à pain ou fruits

METALL



	Ø cm	↑ cm	Farbe / Colour
30207	21	16,5	copper-look handle
30208	30	19,0	copper-look handle



Brot- und Obstkorb

basket for bread or fruits
cesta para pan o fruta
corbeille à pain ou fruits

METALL
VERCHROMT



	Ø cm	↑ cm
30310	18	7,5

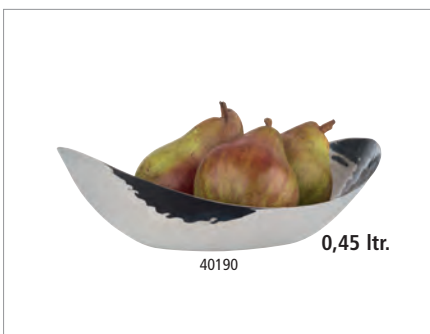

Schale

bowl
cuenco
bol

EDELSTAHL
STAINLESS
INOX



gehämmerte Oberfläche / hammered surface / superficie martillada / surface martelée

	cm	↑ cm	ltr.
40189	20 x 13,5	5,5	0,30
40190	24 x 16,5	7,0	0,45

BASKETS



Brot- und Obstschale

bowl for bread or fruits
bol para pan o fruta
bol à pain ou à fruits

EDELSTAHL
STAINLESS
INOX



hochglanzpoliert, Hammerschlag Optik
mirror polished finish, hammered look
acabado pulido efecto espejo, aspecto repujado
brillant, aspect martelé

	Ø cm	↑ cm
30276	16	5,0
30277	20	5,5



Schale

bowl
bandeja
corbeille

EDELSTAHL
STAINLESS
INOX



ingerollter Rand
rolled edge
borde redondeado
bord roulé

	cm	↑ cm
40110	26,5 x 18,5	4,0
40115	31,0 x 21,0	4,5





Korb / Ständer „APS PLUS“

basket / riser
cesta / soporte
corbeille / support

METALL



	Ø cm	↑ cm	Farbe / Colour
15320	10,5 / 8	8	 polished chrome
15324	10,5 / 8	8	 brushed gold
15322	10,5 / 8	8	 brushed copper





Korb / Ständer „APS PLUS“

basket / riser
cesta / soporte
corbeille / support

METALL



	Ø cm	↑ cm	Farbe / Colour
15321	21 / 15	11	 polished chrome
15325	21 / 15	11	 brushed gold
15323	21 / 15	11	 brushed copper



Korb / Ständer „ASIA PLUS“

basket / riser
cesta / soporte
corbeille / support



	Ø cm	↑ cm	Farbe / Colour
15331	15	10,5	polished chrome
15332	21	20,0	polished chrome
15334	15	10,5	brushed gold
15335	21	20,0	brushed gold



Korb / Ständer „ASIA PLUS“

basket / riser
cesta / soporte
corbeille / support



	Ø cm	↑ cm	Farbe / Colour
15326	21 / 15	21	



Buffetständer / -korb „ASIA PLUS“

buffet stand / basket
soporte para buffet / cesta
présentoir buffet / corbeille



	Ø cm	↑ cm	Farbe / Colour
15507	15	10,5	



Buffetständer / -korb „ASIA PLUS“

buffet stand / basket
soporte para buffet / cesta
présentoir buffet / corbeille



	Ø cm	↑ cm	Farbe / Colour
15508	21	10,5	



Buffetständer / -korb „ASIA PLUS“

buffet stand / basket
soporte para buffet / cesta
présentoir buffet / corbeille



	Ø cm	↑ cm	Farbe / Colour
15509	21	20	





Chafing Dish, GN Container & Transport

EASY INDUCTION



die Deckelbremse sorgt für langsames Schließen

the revolving cover closes gently, thanks to a special built-in axle

sistema de freno para un cierre suave de la tapa

système avec frein pour une fermeture en douceur du couvercle



Druckhebel zum leichten Entnehmen des GN-Behälters

stick for easy removing of the GN-container

dispositivo para levantar y quitar con facilidad la cubeta GN

dispositif pour lever et retirer facilement le bac GN



abnehmbarer Glas-Deckel mit Wasserrücklaufsystem

removable glass lid, with water-runback-system

tapa transparente desmontable con sistema de retorno de la condensación

couvercle transparent amovible avec système de retour de la condensation



Fixierschraube verhindert das Rutschen

fixing screw for skid resistance

Pie trasero anti-deslizante, altura regulable

Pied supplémentaire anti-dérapant réglable en hauteur



Lieferung ohne Induktionskochplatte
delivery without induction plate
se entrega sin placa de inducción
livré sans plaque à induction

GN 1/1 Chafing Dish „EASY INDUCTION“



1 Gestell + 1 Wasserbecken mit Sandwichboden + 1 Deckel mit hydraulischem Gelenk + 1 GN 1/1 Behälter 65 mm tief, hitzebeständige Griffe, hochwertige Verarbeitung, ausschließlich für Induktionskochfelder

1 frame + 1 waterpan with sandwich base + 1 hydraulic cover + 1 GN 1/1 container 65 mm, heat-resistant handles, high quality, only for induction plates

1 marco + 1 baño maría con base sandwich + 1 marco con tapa hidráulica + 1 cubeta GN 1/1 pan 65 mm profundo, asas resistentes al calor, buenos acabados, solamente para inducción

1 pied support + 1 bac bain-marie avec fond sandwich + 1 cadre avec couvercle hydraulique + 1 bac GN 1/1 - 65mm, poignées résistantes à la chaleur, belle qualité, uniquement pour induction

	cm	↑ cm	GN	ltr.
12322	60 x 42	30	1/1	9



Lieferung ohne Induktionskochplatte
delivery without induction plate
se entrega sin placa de inducción
livré sans plaque à induction

GN 2/3 Chafing Dish „EASY INDUCTION“



1 Gestell + 1 Wasserbecken mit Sandwichboden + 1 Wasserbeckenrahmen + 1 Deckel mit hydraulischem Gelenk + 1 GN 2/3 Behälter 65 mm tief, hitzebeständige Griffe, hochwertige Verarbeitung, ausschließlich für Induktionskochfelder

1 frame + 1 waterpan with sandwich base + 1 frame for waterpan + 1 hydraulic cover + 1 GN 2/3 container 65 mm, heat-resistant handles, high quality, only for induction plates

1 marco + 1 baño maría con base sandwich + 1 marco con tapa hidráulica + 1 cubeta GN 2/3 pan 65 mm profundo, asas resistentes al calor, buenos acabados, solamente para inducción

1 pied support + 1 bac bain-marie avec fond sandwich + 1 cadre avec couvercle hydraulique + 1 bac GN 2/3 - 65mm, poignées résistantes à la chaleur, belle qualité, uniquement pour induction

	cm	↑ cm	GN	ltr.
12323	42 x 41	30	2/3	5,5





Lieferung ohne Induktionskochplatte
delivery without induction plate
se entrega sin placa de inducción
livré sans plaque à induction

Chafing Dish „EASY INDUCTION“



1 Gestell + 1 Wasserbecken mit Sandwichboden + 1 Deckel mit hydraulischem Gelenk + 1 runder Speisenbehälter, hitzebeständige Griffe, hochwertige Verarbeitung, ausschließlich für Induktionskochfelder geeignet

1 frame + 1 waterpan with sandwich base + 1 hydraulic cover + 1 round foodpan, heat-resistant handles, high quality, good for induction plates

1 soporte + 1 baño maría con base sandwich + 1 tapa hidráulica + 1 cubeta redonda, asas resistente al calor, buen acabado, apto para inducción

1 pied support + 1 bac bain-marie avec fond sandwich + 1 cadre avec couvercle hydraulique + 1 bac rond, poignées résistantes à la chaleur, belle qualité, uniquement pour induction

	cm	↑ cm	ltr.
12324	46 x 50	30	6



Lieferung ohne Induktionskochplatte
delivery without induction plate
se entrega sin placa de inducción
livré sans plaque à induction

Chafing Dish „EASY INDUCTION“



1 Gestell + 1 Wasserbecken mit Sandwichboden + 1 Deckel mit hydraulischem Gelenk + 1 runder Speisenbehälter, hitzebeständige Griffe, hochwertige Verarbeitung, ausschließlich für Induktionskochfelder geeignet

1 frame + 1 waterpan with sandwich base + 1 hydraulic cover + 1 round foodpan, heat-resistant handles, high quality, good for induction plates

1 soporte + 1 baño maría con base sandwich + 1 tapa hidráulica + 1 cubeta redonda, asas resistente al calor, buen acabado, apto para inducción

1 pied support + 1 bac bain-marie avec fond sandwich + 1 cadre avec couvercle hydraulique + 1 bac rond, poignées résistantes à la chaleur, belle qualité, uniquement pour induction

	cm	↑ cm	ltr.
12325	48 x 42	39	11



Induktionskochplatte für Chafing Dish

induction plate for chafing dish
placa de inducción para chafing dish
plaque à induction pour chafing dish

mit Regler
with power control
con control de potencia
avec régulateur

	Ø cm	
12295	24	900 W



82210
4,3 ltr.

82215
2 x 2 ltr.

Porzellan-Einsatz
porcelain insert
bandeja de porcelana
bac supérieur en porcelaine



	Ø cm	↑ cm	ltr.	fits to
82210	39	6	4,3	12324
82215	39	6	4,0	12324

PREMIUM



langlebige Deckelbremse
Abnehmbarer Deckel, dieser lässt sich spielend leicht öffnen und schließen, der Lauf des Deckels wird professionell gedämpft.



Kondenswasser - Rücklaufsystem
Kondenswasser wird in das Wasserbecken zurückgeführt.



Sandwichboden / Kapselboden
Induktionsfähiger Boden, direkt auf dem Induktionskochfeld einsetzbar. Perfekte Wärmeverteilung und Steuerung.



Fixierschraube / Rutschsicherung
Höhenverstellbares Gelenk, fixiert das Gerät in dem Gestell und auf dem Tisch.



Induktionskochplatte Nr. 12295
Induktionskochplatte wird einfach in das Gestell gelegt.



stapelbar
Chafing Dish Rahmen sind übereinander stapelbar. Platzsparend und rutschfest stapeln und transportieren.



Induktionskochplatte für Chafing Dish

induction plate for chafing dish
placa de inducción para chafing dish
plaque à induction pour chafing dish

mit Regler
with power control
con control de potencia
avec régulateur

	Ø cm	
12295	24	900 W



12370

Lieferung ohne Induktionskochplatte
delivery without induction plate
se entrega sin placa de inducción
livré sans plaque à induction

GN 1/1 Chafing Dish „PREMIUM“



1 Gestell + 1 Wasserbecken mit Sandwichboden + 1 Wasserbeckenrahmen + 1 Deckel mit hydraulischem Gelenk + 1 GN 1/1 Behälter 65 mm tief, hitzebeständige Griffe, hochwertige Verarbeitung, ausschließlich für Induktionskochfelder

1 frame + 1 waterpan with sandwich base + 1 frame for waterpan + 1 hydraulic cover + 1 GN 1/1 container 65 mm, heat resistant handles, high quality, only for induction plates

1 soporte + 1 cubeta baño maría con base sandwich + 1 marco para cubeta baño maría + 1 tapa hidráulica + 1 cubeta GN 1/1 de 65 mm, asas resistentes al calor, acabado de alta calidad, solamente para inducción

1 pied support + 1 bac bain-marie avec fond sandwich + 1 cadre pour bac bain-marie + 1 couvercle hydraulique + 1 bac GN 1/1 de 65 mm, poignées résistantes à la chaleur, finition de qualité, uniquement pour induction

	cm	↑ cm	ltr.	
12370	66 x 48	33	9	mit Edelstahldeckel with stainless steel cover
12352	66 x 48	33	9	mit Glasdeckel with glass cover



12353

Lieferung ohne Induktionskochplatte
delivery without induction plate
se entrega sin placa de inducción
livré sans plaque à induction

Chafing Dish rund „PREMIUM“



1 Gestell + 1 Wasserbecken mit Sandwichboden + 1 Wasserbeckenrahmen + 1 Deckel mit hydraulischem Gelenk + 1 runder Speisenbehälter, hitzebeständiger Griff, hochwertige Verarbeitung, für Induktionskochfelder geeignet

1 frame + 1 waterpan with sandwich base + 1 frame for waterpan + 1 hydraulic cover + 1 round foodpan, heat resistant handle, high quality, suitable for induction plates

1 soporte + 1 cubeta baño maría con base sandwich + 1 marco para cubeta baño maría + 1 tapa hidráulica + 1 cubeta redonda, asa resistente al calor, acabado de alta calidad, apto para inducción

1 pied support + 1 bac bain-marie avec fond sandwich + 1 cadre pour bac bain-marie + 1 couvercle hydraulique + 1 bac rond, poignée résistante à la chaleur, finition de qualité, apte pour induction

	cm	↑ cm	ltr.	
12371	44 x 54	33	6	mit Edelstahldeckel with stainless cover
12353	44 x 54	33	6	mit Glasdeckel with glass cover

Speiseneinsatz / foodpan / cubeta / bac supérieur

12366



12372

Lieferung ohne Induktionskochplatte
delivery without induction plate
se entrega sin placa de inducción
livré sans plaque à induction

Chafing Dish rund „PREMIUM“



1 Gestell + 1 Wasserbecken mit Sandwichboden + 1 Wasserbeckenrahmen + 1 Deckel mit hydraulischem Gelenk + 1 runder Speisenbehälter, hitzebeständige Griffe, hochwertige Verarbeitung, für Induktionskochfelder geeignet

1 frame + 1 waterpan with sandwich base + 1 frame for waterpan + 1 hydraulic cover + 1 round foodpan, heat resistant handles, high quality, suitable for induction plates

1 soporte + 1 cubeta baño maría con base sandwich + 1 marco para cubeta baño maría + 1 tapa hidráulica + 1 cubeta redonda, asas resistentes al calor, acabado de alta calidad, apto para inducción

1 pied support + 1 bac bain-marie avec fond sandwich + 1 cadre pour bac bain-marie + 1 couvercle hydraulique + 1 bac rond, poignées résistantes à la chaleur, finition de qualité, apte pour induction

	cm	↑ cm	ltr.	
12372	44 x 48	39	10	mit Edelstahldeckel with stainless cover
12354	44 x 48	39	10	mit Glasdeckel with glass cover

Speisenbehälter / foodpan / cubeta superior / bac supérieur

12397

GLOBE



die Deckelbremse sorgt für langsames Schließen

the revolving cover closes gently, thanks to a special built-in axle

resistencia los frenos del sistema garantizan un cierre suave de la tapa

système avec frein pour une fermeture en douceur du couvercle



abnehmbarer Deckel mit Wasserrücklaufsystem

lid can be taken off, with water runback system

tapa fácil de desmontar, y canal incorporado para recuperar el agua condensada

couvercle facile à démonter, rainure pour récupérer les gouttes de condensation



Kondenswasser wird in das Wasserbecken zurückgeführt

condensed water is led back into the waterpan

el agua de condensación vuelve a la cubeta de agua

l'eau de condensation retourne dans le bac d'eau



für alle Herdarten geeignet, auch für Induktionskochplatten

suitable for all kinds of ovens, even induction cookers

apto para todas las fuentes de calor, incluso inducción

apte pour toutes les sources de chaleur, y compris induction



GN 1/1 Chafing Dish „GLOBE“



hochglanzpoliert, mit abnehmbarem hydraulischem Edelstahl-Deckel, Sandwichboden sorgt für optimale Wärmeleitung, für Induktionsplatten geeignet, Set: Gestell + Wasserbecken + Speisenbehälter GN 1/1 65 mm tief, 9 Liter + Löffelablage + 2 Brennpastenbehälter + Metallrahmen für Induktionskochplatte

mirror polished finish, removable stainless steel hydraulic cover, sandwich base for optimum heat distribution, suitable for induction plates

set: frame + waterpan + GN 1/1 container 65 mm, 9l + cutlery compartment ladles + 2 burner holder + frame for induction plate

pulido brillante, tapa hidráulica de acero inoxidable extraíble, fondo difusor sandwich apto para inducción, incluye: soporte + cubeta baño maría + cubeta GN 1/1 de 65 mm, 9 l + soporte para cuchara (sin cuchara) + 2 quemadores + marco para la placa de inducción

poli brillant, couvercle inox hydraulique amovible, fond diffuseur sandwich apte pour induction, comprend: pied support + bac bain-marie + bac GN 1/1 de 65 mm, 9 l + porte-louche (louche non incluse) + 2 brûleurs + cadre inox pour la plaque à induction

	cm	↑ cm	ltr.	
12394	66,5 x 44	34	9	mit Edelstahldeckel with stainless cover
12404	66,5 x 44	34	9	mit Glasdeckel with glass cover

Induktionskochplatte für Chafing Dish / induction plate for chafing dish / placa de inducción para chafing dish / plaque à induction pour chafing dish

12295

Metallrahmen für Induktionskochplatte / frame for induction plate / estructura o marco para placa de inducción / cadre support inox pour plaque induction

12296



Suppen-Kugel inkl. Gestell „GLOBE“

soup bowl with stand
cubeta sopa con soporte
récipient à soupe avec pied



hochglanzpoliert, inkl. Speisenbehälter, 1 Brennpastenbehälter, mit einhängbarer Löffelablage, Sandwichboden sorgt für optimale Wärmeverteilung, für Induktionsplatten geeignet, einfaches Anbringen und Entfernen des Deckels, hitzeisolierende Griffe, 1 Metallrahmen für Induktionskochplatten

mirror polished finish, incl. foodpan and 1 burner holder, with fitting compartment for ladles, sandwich bottom for optimum heat distribution, gentle opening of the lid, heat-resistant handles, frame for induction plate

acabado pulido brillante, cubeta sopa inox, 1 quemador, platillo a colgar para el cucharón, fondo difusor sandwich, apto para inducción, tapa con apertura controlada, asas frías, marco para placa de inducción

poli brillant, récipient à soupe inox, 1 brûleur, repose-couvert à accrocher, fond diffuseur sandwich, apte pour induction, couvercle à ouverture contrôlée, anses froides, cadre support inox pour plaque à induction

	Ø cm	↑ cm	ltr.
12398	48	45	10

Induktionskochplatte für Chafing Dish / induction plate for chafing dish / placa de inducción para chafing dish / plaque à induction pour chafing dish

12295

Metallrahmen für Induktionskochplatten / frame for induction plate / marco para placa de inducción / cadre support inox pour plaque induction

12291

Suppen-Kugel „GLOBE“

soup bowl
cubeta sopa
récipient à soupe



hochglanzpoliert, inkl. Speisenbehälter, mit einhängbarer Löffelablage, Sandwichboden sorgt für optimale Wärmeverteilung, für Induktionsplatten geeignet, einfaches Anbringen und Entfernen des Deckels, hitzeisolierende Griffe (Lieferung ohne Gestell, Löffel)

mirror polished finish, incl. foodpan, with fitting compartment for ladles, sandwich bottom for optimum heat distribution, gentle opening of the lid, heat-resistant handles (delivery without rack, ladle)

acabado pulido brillante, cubeta sopa inox, platillo a colgar para el cucharón, fondo difusor sandwich, apto para inducción, tapa con apertura controlada, asas frías (cucharón no incluido)

poli brillant, récipient à soupe inox, repose-couvert à accrocher, fond diffuseur sandwich, apte pour induction, couvercle à ouverture contrôlée, anses froides (cadre, louche non incluse)

	Ø cm	↑ cm	ltr.
12399	48	32	10

Gestell inkl. Brenner / frame incl. burner / soporte incluyendo quemador / support, brûleur inclus

12396

Speisenbehälter / foodpan / cubeta superior / bac supérieur

12397





Chafing Dish „GLOBE“



hochglanzpoliert, mit abnehmbarem hydraulischen Edelstahl-Deckel, Sandwichboden sorgt für optimale Wärmeleitung, für Induktionsplatten geeignet

Set: Gestell + Wasserbecken + Speisenbehälter rund + Löffelablage + Brennpastenbehälter + Metallrahmen für Induktionskochplatte

mirror polished finish, removable hydraulic cover, sandwich base, optimum heat distribution set: frame + waterpan + foodpan round + cutlery compartment ladles + burner holder + frame for induction plate

pulido brillante, con tapa hidráulica extraíble, fondo difusor sandwich apto para inducción. Incluye: 1 pie, 1 cubeta baño maría, 1 cubeta redonda, 1 soporte para cuchara (sin cuchara), 1 quemador, marco inox para la placa de inducción

brillant, couvercle hydraulique amovible, fond diffuseur sandwich apte pour induction. Comprend: pied, cuve bain-marie, bac inox rond, porte-louche (louche non incluse), 1 brûleur, cadre inox pour la plaque à induction

	Ø cm	↑ cm	ltr.	
12393	38,5	34	6	mit Edelstahldeckel with stainless cover
12403	38,5	34	6	mit Glasdeckel with glass cover

Induktionskochplatte für Chafing Dish / induction plate for chafing dish / placa de inducción para chafing dish / plaque à induction pour chafing dish

12295

Metallrahmen für Induktionskochplatten / frame for induction plate / marco para placa de inducción / cadre support inox pour plaque induction

12291

Speiseneinsatz / foodpan / cubeta / bac supérieur

12366



Porzellan-Einsatz

porcelain insert
bandeja de porcelana
bac supérieur en porcelaine



	Ø cm	↑ cm	ltr.	fits to
82210	39	6	4,3	12393, 12403
82215	39	6	4,0	12393, 12403



GN 2/3 Chafing Dish „GLOBE“



hochglanzpoliert, mit abnehmbarem hydraulischem Edelstahl-Deckel, Sandwichboden sorgt für optimale Wärmeleitung, für Induktionsplatten geeignet, Set: Gestell + Wasserbecken + 1 GN 2/3 Behälter 65 mm tief + Löffelablage + 1 Brennpastenbehälter + 1 Metallrahmen für Induktionskochplatte

mirror polished finish, removable hydraulic cover, sandwich base, optimum heat distribution, set: frame + waterpan + foodpan GN 2/3, 65 mm, 5,5 l + compartment for ladles + burner holder + frame for induction plate

pulido brillante, con tapa hidráulica extraíble, fondo difusor sandwich apto para inducción. Incluye: 1 pie, 1 cubeta baño maría, 1 cubeta GN 2/3 65 mm - 5,5 l, 1 soporte para cuchara (sin cuchara), 1 quemador, marco inox para la placa de inducción

poli brillant, couvercle hydraulique amovible, fond diffuseur sandwich apte pour induction. Comprend: pied, cuve bain-marie, bac inox GN 2/3-65 mm - 5,5 L, porte-louche (louche non incluse), brûleur, cadre inox pour la plaque à induction

	cm	↑ cm	ltr.	
12483	44 x 41	34	5,5	mit Edelstahl-Deckel with stainless steel cover
12484	44 x 41	34	5,5	mit Glasdeckel with glass cover



Rolltop-Chafing Dish „MAESTRO“



Speisenbehälter GN1/1 65 mm tief (passend auch für 100 mm) + Rolltop-Deckel 90° + Wasserbecken inkl. Vorrichtung für Heizplatte + 2 Brennpastenbehälter

foodpan GN1/1 65 mm (also for 100 mm) + rolltop cover 90° + waterpan with screws for heating unit + 2 burner holders

cubeta GN 1/1 - 65 mm (hay espacio para una cubeta 100 mm) + campana rolltop abatible a 90° + 2 quemadores

bac GN 1/1 - 65 mm (accepte aussi bac ht. 100 mm) + couvercle rolltop ouverture 90° + 2 brûleurs

	cm	↑ cm	ltr.
12300	67 x 35	45	9



Rolltop-Chafing Dish „ELITE“

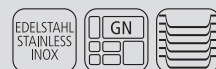

poliert, Rolltop-Deckel klappbar auf 90° und 180°, Speisenbehälter GN 1/1 65 mm tief + Wasserbecken + 2 Brennpastenbehälter, wechseln des GN-Behälters ohne Abnehmen des Deckels (kein Kondenswasser-Rücklaufsystem)

polished, rolltop cover adjustable at 90° and 180°, foodpan GN 1/1 65 mm deep + waterpan + 2 burner holders, change of the GN container without removing the lid (condensed water can not be led back into the waterpan)

pulido brillante, tapa rolltop a 90° o 180°, cubeta GN 1/1 + 2 quemadores, cuba baño maría, se puede cambiar la cubeta GN sin retirar la tapa, importante: el agua condensada no revierte en los alimentos

poli brillant, couvercle rolltop ouverture de 90 a 180°, bac GN 1/1, bain-marie, 2 brûleurs, le bac GN peut être retiré et remplacé sans démonter le couvercle, important: la condensation ne retombe pas sur les aliments

	cm	↑ cm	ltr.
12350	67 x 47	45	9

Wasserbecken inkl. Vorrichtung für Heizelement / waterpan / baño maría / bain-marie

12249



inkl. Vorrichtung für Heizelement
incl. screws for heating unit



Rolltop-Chafing Dish „CATERER“



Speisenbehälter GN 1/1 65 mm tief + Rolltop-Deckel 90° + Wasserbecken inkl. Vorrichtung für Heizplatte + 2 Brennpastenbehälter (Lieferung ohne Heizplatte), massiver Ständer
 foodpan GN 1/1 65 mm deep + rolltop cover 90° + waterpan with screws for heatingunit + 2 burner holders (without heating unit), stable frame
 1 cubeta GN 1/1 - 65 mm + campana rolltop abatible a 90° + 2 quemadores + cuba baño maría con fijaciones para resistencia amovible (se sirve sin la resistencia)
 1 bac GN 1/1 - 65 mm + couvercle rolltop ouverture 90° + 2 brûleurs + 1 bac bain-marie avec 4 vis pour fixation résistance de chauffe amovible (non include)

	cm	↑ cm	ltr.
12245	67 x 35	45	9

Wasserbecken inkl. Vorrichtung für Heizelement / waterpan / baño maría / bain-marie

12249



Chafing Dish „CATERER PRO“



Deckel hochglanzpoliert, Deckelgriffe hitzebeständig + 2 Brennpastenbehälter + Wasserbecken, inkl. Vorrichtung für Heizplatte + Gestell mit Deckelhalterung (ohne GN Speisenbehälter)
 cover mirror polished finish, cover knob heat-resistant + 2 burner holders + waterpan with screws for heating unit + frame with coverholder (without GN foodpan)
 tapa pulido brillante, asas frías + 2 quemadores + cuba inferior con tornillos para resistencia removable (no incluida) + tapa y estructura con sujeción de la tapa (se sirve sin la cubeta GN)
 couvercle poli brillant, anses froides + 2 brûleurs + bac bain-marie avec fixations pour résistance amovible (non include)

	cm	↑ cm
12233	64 x 35	34

Ersatzdeckel / replacement cover / tapa de recambio / couvercle de rechange

12236

Wasserbecken inkl. Vorrichtung für Heizelement / waterpan / baño maría / bain-marie

12249



Chafing Dish „CHEF“



Speisenbehälter GN 1/1 65 mm tief + 2 Brennpastenbehälter + Wasserbecken + Deckel + Gestell mit Deckelhalterung + langer Hohlgriff
 foodpan GN 1/1 65 mm + 2 burner holders + waterpan + cove + frame with coverholder
 1 cubeta GN 1/1 65 mm + 2 quemadores + cubeta para el agua + tapa y chasis con bloqueo para la tapa
 1 bac GN 1/1 - 65 mm + 2 brûleurs + 1 bac bain-marie + couvercle + chasis avec blocage couvercle + poignée tube creux

	cm	↑ cm	ltr.
11675	61 x 31	30	9



Die Induktionsstation mit Regler präsentiert sich in einem Set aus Walnussholz, einem schwarzen Metallständer und einer Induktionsheizung.

The induction station with controller is presented in a set of walnut wood, a black metal stand and an induction heater.

La estación de inducción con regulador se presenta en un set formado por una caja de madera de nogal, un soporte de metal negro y un calentador de inducción.

La station à induction avec température réglable se compose d'un caisson en bois noyer, d'un support métallique noir et d'une plaque à induction.



Induktionsstation, 4-tlg. Set

induction station, 4 pcs.
estación de inducción, set de 4
station d'induction, set de 4



- 4 teiliges Set:
- 1 Induktionskochplatte mit Regler (Ø 24 cm, 900 Watt)
 - 1 Metallständer schwarz
 - 1 Rahmen aus Walnussholz geölt
 - 1 Edelstahlrahmen

- 4 pcs. set:
- 1 induction hotplate with controller (Ø 24 cm, 900 Watt)
 - 1 metal stand black
 - 1 frame in oiled walnut wood
 - 1 stainless steel frame

- set de 4:
- 1 placa de inducción con regulador (Ø 24 cm, 900 vatios)
 - 1 soporte de metal negro
 - 1 caja de madera de nogal aceitada
 - 1 marco de acero inoxidable

- set de 4:
- 1 plaque d'induction avec température réglable (Ø 24 cm, 900 watts)
 - 1 support métallique noir
 - 1 caisson en bois noyer huilé
 - 1 cadre en acier inox

	cm	↑ cm
12270	35,4 x 32,5	19



passendes Chafing Dish Set 12330
suitable chafing dish set 12330

Ersatzteile / replacement parts / piezas de repuesto / pièces de rechange

	cm	↑ cm	
12271	35,4 x 32,5	8,5	Holzrahmen / wooden frame
12272	29,5 x 26,5	1	Edelstahlrahmen / stainless steel frame
12295	Ø 24	-	900 Watt Induktionskochplatte / induction plate
15506	35,4 x 32,5	17,6	Buffetständer schwarz / buffet stand black

NEW

4 tlg.
4 pcs.



12330



12335



12336



12337



12338



12329

4 ltr.

Chafing Dish, 4-teiliges Set

chafing dish set, 4 pcs.
chafing dish, set de 4
chafing dish, set de 4



4-teiliges Set:

- 1 Topf (8 Liter)
- 1 Speisenbehälter (4 Liter)
- 1 Deckel mit Sichtfenster und 1 Deckelbremse,
- Topf mit induktionsfähigem Sandwich- / Kapselboden

4 pcs. set:

- 1 pot (8 litres),
- 1 foodpan (4 litres)
- 1 lid with glass insert and 1 automatic lid brake
- pot with induction-compatible sandwich base

set de 4:

- 1 olla (8 litros)
- 1 cubeta (4 litros)
- 1 tapa con ventanilla y 1 sistema de freno en la tapa
- olla con base sandwich apta para inducción

set de 4:

- 1 casserole (8 litres)
- 1 bac (4 litres)
- 1 couvercle avec fenêtre et 1 système de frein dans le couvercle
- casserole avec fond sandwich pour induction

	Ø cm	↑ cm	ltr.	Farbe / Colour	
12330	30,5	17,5	4		stainless
12335	30,5	17,5	4		copper
12336	30,5	17,5	4		yellow
12337	30,5	17,5	4		red
12338 <small>NEW</small>	30,5	17,5	4		black



12336

abnehmbarer Deckel
removable lid



induktionsgeeignet
suitable for induction

Ersatz-Speisenbehälter zu Chafing Dish / replacement foodpan for chafing dish / cubeta interior de repuesto para chafing dish / bac intérieur de remplacement pour le chafing dish

	Ø cm	↑ cm	ltr.	fits to
12329	30,5	8	4	12330, 12335, 12336, 12337, 12338



Ø 33 cm

8 ltr. Topf
8 ltr. pot



Sandwich- / Kapsel-
boden / sandwich base



Ø 30,5 cm

4 ltr. Speisenbehälter
4 ltr. foodpan



Deckelbremse
automatic lid break



GN 1/1 100 mm
14 ltr.

Elektro-Rolltop-Chafing Dish „ELITE“

electric rolltop chafing dish
chafing dish eléctrico rolltop
chafing dish électrique rolltop



poliert, Rolltop-Deckel klappbar auf 90° und 180°, Elektro-Wasserbecken mit Temperaturregelung + Speisenbehälter GN 1/1 100 mm tief, 220 - 240 V ~ 50 Hz; 760 - 900 W (kein Kondenswasser-Rücklaufsystem)

polished, rolltop cover adjustable at 90° and 180°, electric waterpan with adjustable heatcontrol + foodpan GN 1/1 100 mm deep, voltage 220 - 240 V ~ 50 Hz, power consumption 760 - 900 W (condensed water cannot be led back into the waterpan)

pulido brillante, tapa abatible apertura a 90° o 180°, baño maría c/ termostato + cubeta GN 1/1 - 100 mm, 220-240 V-50 Hz. Consumo 760-900 W (el agua condensada no gotea dentro de la cubeta)

poli brillant, couvercle rolltop ouverture à 90° ou 180°, bain-marie électrique avec thermostat + bac GN 1/1-100 mm, 220-240 V - 50 Hz; 760-900 W (Important: la condensation ne retombe pas sur les aliments)

	cm	↑ cm	ltr.
12360	67 x 47	45	14



hot price

Elektrischer Suppentopf „ECONOMIC“

electric soup warmer
marmita de sopa eléctrica
marmite à soupe électrique



Stahl schwarz lackiert, herausnehmbarer Einsatz aus Edelstahl, Temperaturregelung 30°C - 90°C, dreh- und klappbarer Edelstahl-Deckel, inkl. 8 magnetisch haftenden Beschriftungen, 400 W / 230 V

metal, black, removable soup pot, thermostat 30°C - 90°C, st. steel lid, incl. 8 magnetic signs, 400 W / 230 V

metal negro, recipiente sopa inox extraíble, termostato 30°C- 90°C, tapa inox, incluye 8 letreros magnéticos, 400 W / 230 V

acier, noir, récipient à soupe inox amovible, thermostat 30°C - 90°C, couvercle inox, 8 étiquettes magnétiques, 400 W / 230 V

	Ø cm	↑ cm	ltr.
11915	32	36	9

Speisenbehälter / foodpan / recipiente sopa / récipient à soupe

11916

Deckel / cover / tapa / couvercle

11917



Elektro Chafing Dish

electric chafing dish
chafing dish eléctrico
chafing dish électrique



Speisenbehälter GN 1/1 100 mm tief, Deckelhalter, Thermostat-Regelung 900 W, 230 V

foodpan GN 1/1 100 mm deep, lid holder, thermostat control 900 W, 230 V

cubeta GN 1/1-100 mm, sujeción de la tapa, termostato, 900W, 230 V

bac GN 1/1-100 mm, blocage du couvercle, thermostat, 900W, 230 V

	cm	↑ cm	ltr.
12225	63 x 36	29	14

Deckel / cover / tapa / couvercle

12235



Elektro-Chafing Dish „ECO“

electric chafing dish
chafing dish eléctrico
chafing dish électrique



Deckel poliert, Elektro-Wasserbecken mit Temperaturregelung + Speisenbehälter GN 1/1 65 mm tief, 220 - 240 V ~ 50 Hz; 760 - 900 W

cover polished, electric waterpan with adjustable heatcontrol + foodpan GN 1/1 65 mm deep, voltage 220 - 240 V ~ 50 Hz, power consumption 760 - 900 W

tapa pulido brillante, baño maría c/ termostato + cubeta GN 1/1 - 65 mm - 220-240 V-50 Hz. / 760-900 W

couvercle poli brillant, bain-marie électrique avec thermostat + bac GN 1/1-65 mm, 220-240 V - 50 Hz; 760-900 W

	cm	↑ cm	ltr.
12232	63 x 36	29	9



Elektrischer Suppentopf

electric soup warmer
marmita de sopa eléctrica
marmite à soupe électrique



herausnehmbarer Einsatz aus Edelstahl, elektrisch, mit Wasserbad + Löffel + integrierter Tragering für den Innenbehälter, Deckel mit hitzeisolierendem Griff, Temperaturregelung 80°C (± 10°C), 450-550 W, 230 V

removable soup st. steel pan, bain marie electric, ladle, circular frame, thermostat control till 80°C (± 10°C), 450-550 W, 230 V

recipiente sopa inox extraíble, baño maría eléctrico + cucharón + aro inox, tapa con asas frías, termostato hasta 80°C precisión (± 10°C), 450-550 W, 230 V

réipient à soupe inox amovible, bain-marie électrique, louche, support circulaire inox, thermostat maxi 80°C (± 10°C), 450-550 W, 230 V

	Ø cm	↑ cm	ltr.
11901	38	36,5	10



Elektrischer Suppentopf

electric soup warmer
marmita de sopa eléctrica
marmite à soupe électrique



herausnehmbarer Einsatz aus Edelstahl, elektrisch, mit Wasserbad + Löffel + integrierter Tragering für den Innenbehälter, Deckel mit hitzeisolierendem Griff, Temperaturregelung 80°C (± 10°C), 400 - 450 W / 220 - 240 V

removable soup st. steel pan, bain marie electric, ladle, st. steel circular frame, thermostat control till 80°C (± 10°C), 400 - 450 W / 220 - 240 V

recipiente sopa inox extraíble, baño maría eléctrico + cucharón + aro inox, tapa con asas frías, termostato hasta 80°C precisión (±10°C), 400 - 450 W / 220 - 240 V

réipient à soupe inox amovible, bain-marie électrique, louche, support circulaire inox, thermostat maxi 80°C (± 10°C), 400 - 450 W / 220 - 240 V

	Ø cm	↑ cm	ltr.
11910	40	37	10

Edelstahlgefäß / stainless steel pan / recipiente sopa inox / réipient à soupe inox

11911

Edelstahl-Deckel / stainless steel lid / tapa inox / couvercle inox

11912

Elektrokabel / electric cable / cable eléctrico / cable électrique

11913



Fondue und Feuerzangenbowl-Set „TWO IN ONE“

fondue and fire punch bowl set
set para fondue o ponche caliente
service à fondue et à punch



13-teiliges Set aus Edelstahl bestehend aus:
1 Topf, 1 Rechaud, 1 Spritzschutz, 1 Untersetzer, 1 Schöpfkelle, 1 Feuerzange,
1 Pastenbrenner, 6 Fonduegabeln

13-piece stainless steel set consisting of:
1 pot, 1 rechaud, 1 splash guard, 1 coaster, 1 ladle, 1 fire tongs,
1 paste burner, 6 fondue forks

set de 13 piezas de acero inoxidable compuesto por:
1 olla, 1 rechaud, 1 protector contra salpicaduras, 1 trébede, 1 cazo,
1 pinza para el fuego, 1 quemador de pasta, 6 tenedores de fondue

set de 13 pièces en acier inox comprenant:
1 marmite, 1 rechaud, 1 pare-éclaboussures, 1 dessous de plat, 1 louche, 1 pince à feu,
1 brûleur à pâte, 6 fourchettes à fondue

	Ø cm	↑ cm	ltr.
65060	22	23	2,2

Brennpastenbehälter zu 65060 / fuel paste container for 65060 / recipiente para pasta de combustible para 65060 / récipient pour pâte à combustible pour 65060



	cm	↑ cm	fits to
65061	26 x 12	10	65060

Gabelset zu 65060 / fork set for 65060 / set de tenedores para 65060 / set de fourchettes pour 65060



	cm	→ cm	pcs.	fits to
65062	24	Griff / handle 8	6	65060



Kaffeedispenser „HAPPY HOUR“

coffee dispenser
dispensador de café
distributeur de café



hochglanzpoliert, für warme Getränke, stabil und standfest, inkl. 1 Brennpastenbehälter
mirror polished finish, for warm drinks, solid and stable, incl. 1 burner holder
acabado pulido brillante para bebidas calientes, sólido y estable, incluye un calentador
brillant, pour boissons chaudes, avec 1 brûleur, robuste et stable

	cm	↑ cm	ltr.
11672	31 x 33,5	54,5	10,5

Hahn / tap / grifo / robinet

11671

Elektro-Heizelement / heating unit / resistencia / résistance

	cm	↑ cm
12287	21 x 20	6



Rolltophaube „SWISS“

rolltop-cover
campana rolltop
cloche rolltop



hochglanzpoliert, klappbar auf 90°, nachrüstbar für alle handelsüblichen Chafer
mirror polished finish, cover adjustable at 90°, usable for all commercial chafing dishes
pulido brillante, tapa ajustable 90°, apto para todos los chafings profesionales
poli brillant, ouverture réglable à 90°, apte pour tous les chafings professionnels

	cm	↑ cm
12310	55 x 34	19,5



Bain-Marie Topf

bain marie pot
olla baño Maria
marmite bain-marie



inkl. Deckel, mit Löffelaussparung
included cover, notched for spoon
incluye tapa con hueco para la cuchara
inclut le couvercle avec espace pour la louche

	Ø cm	↑ cm	ltr.
12244	20	18	4,5

Deckel / cover / tapa / couvercle

11244



Bain-Marie Deckel

cover for bain marie
tapa del baño maria
couvercle du bain-marie



	cm
12243	54 x 33,5



Einbau-Induktionskochplatte für Chafing Dish

built-in induction plate for chafing dish
placa de inducción para empotrar
plaque à induction à encastrer

inkl. Kabel-Fernbedienung, energiesparend, Leistung in 5 Stufen regelbar, integrierte Lüftung, sehr leise im Betrieb

incl. cable remote control, energy-saving, power adjustable in 5 steps, integrated ventilation, very quiet in operation

incl. mando a distancia con cable, ahorro energético, potencia regulable en 5 pasos, ventilación integrada, funcionamiento silencioso

y compris télécommande filaire, économe en énergie, puissance réglable en 5 étapes, ventilation intégrée, très silencieux en fonctionnement

	cm	↑ cm	
12285	35,5 x 35,5	6	2000 W



Induktionskochplatte für Chafing Dish

induction plate for chafing dish
placa de inducción para chafing dish
plaque à induction pour chafing dish

mit Regler

with power control

con control de potencia

avec régulateur

	Ø cm	
12295	24	900 W



Metallrahmen für Induktionskochplatten

frame for induction plate
marco para placa de inducción
cadre support inox pour plaque induction



12291	für runde Chafer / for round chafing dish
12296	für Chafer GN 1/1 / for GN 1/1 chafing dish



Elektro-Heizelement

heating unit
resistencia
résistance



für Kaffeedispenser (Nr. 11672), 500 W, 220 V, einfach in das Gestell des Dispensers legen

for coffee dispenser (no. 11672), 500 W, 220 V, insert into the frame of the dispenser

para dispensador de café (11672), 500 W, 220V, directamente en el pie del dispensador

pour distributeur à café (11672), 500 W, 220 V, directement dans le support

12287	500 W / 220 V
-------	---------------



Heizplatte durch Spiralfeder an Wasserbad gedrückt
Heating plate is pressed against the water bath by a spiral spring

Mobile Chafing Dish Heizung

heating element
resistencia
résistance



für alle marktgängigen Chafing Dishes / suitable for all current popular chafing dishes, with special spring / para todos los chafing dish más corrientes / pour la plupart des chafing dish les plus courants

	Ø cm	↑ cm	
12299	14	9 - 11	500 W / 220 V

CHAFING DISH · GN CONTAINER · TRANSPORT



Elektro-Heizelement
 heating unit
 resistencia
 résistance

ALU ALUMINIUM Made in Germany

for chafer covers are closed most of the time

12290 360 W / 140 - 250 V

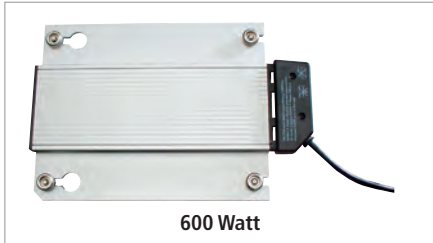

Elektro-Heizelement
 heating unit
 resistencia
 résistance

ALU ALUMINIUM Made in Germany

for chafer covers are open most of the time

12292 600 W / 230 V

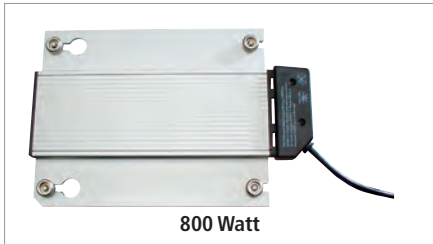

Elektro-Heizelement
 heating unit
 resistencia
 résistance

ALU ALUMINIUM Made in Germany

for chafer covers are open most of the time

12294 800 W / 230 V



Brennpastenbehälter
 burner holder
 quemador
 brûleur

EDELSTAHL STAINLESS INOX

mit Bajonettverschluss / bayonet lock / cierre de bayoneta/ verrouillage par baïonnette

11683 Ø cm ↑ cm
 9 6



Speisenwärmer „PROFI“
 plate warmer
 calienta platos
 chauffe-plat

ALU ALUMINIUM EDELSTAHL STAINLESS INOX

35050 cm ↑ cm
 33 x 18 7 2 Teelichter / 2 tealights / 2 velas / 2 bougies



Speisenwärmer
 warmer
 calienta platos
 chauffe-plat

GLAS GLASS METALL VERCHROMT

3-flammig / 3 lights / 3 velas / 3 bougies

35065 cm ↑ cm
 34 x 18 6



Speisenwärmer
 warmer
 calienta platos
 chauffe-plat

EDELSTAHL STAINLESS INOX

2-flammig / 2 lights / 2 velas / 2 bougies

35343 cm ↑ cm
 34 x 13 6



Wärme-Kies

granite chips
granulado térmico
gravier thermique



für Chafing Dishes, feine Körnung, hohe Wärmespeicherung, kein Verkleben,
ideal zum Warmhalten von Eiern

fine for chafing dishes and clean granite chippings, ideal for keeping eggs warm

gravilla de granito fina limpia, ideal para mantener los huevos calientes

gravier fin de granit, lavé, idéal pour maintenir les oeufs au chaud



81116

7



Besteckablage

cutlery rest
reposa cuchara
pose-cuillère



cm ↑ cm

00650

27 x 11

3,5



Besteckablage „SPOON“

cutlery rest
reposa cuchara
pose-cuillère



cm ↑ cm

83801

26 x 10,5

5



Besteckablage „BOWL“

cutlery rest
reposa cuchara
pose-cuillère



cm ↑ cm ltr.

83803

22,5 x 11

6

0,5



Besteckablage „SMALL WAVE“

cutlery rest
reposa cuchara
pose-cuillère



cm ↑ cm

83897

26 x 13

4,5

CHAFING DISH · GN CONTAINER · TRANSPORT



GN-Behälter „INDU“

GN container
GN cubeta
GN bac



Behälter mit Keramik-Beschichtung, konstanter Antihaft-Effekt

container with ceramic coating, constant non-stick effect

cubeta con revestimiento cerámico, efecto antiadherente constante

bac avec revêtement céramique, effet anti-adhérent constant

	GN	cm	↑ cm	litr.	Farbe / Colour
88200	1/1	53,0 x 32,5	7,5	7,5	White
88201	1/2	32,5 x 26,5	7,5	3,0	White
88202	2/3	35,4 x 32,5	7,5	4,5	White
88205	1/1	53,0 x 32,5	7,5	7,5	Black
88206	1/2	32,5 x 26,5	7,5	3,0	Black
88207	2/3	35,4 x 32,5	7,5	4,5	Black
88209	1/1	53,0 x 32,5	7,5	7,5	Blue
88210	1/2	32,5 x 26,5	7,5	3,0	Blue
88211	2/3	35,4 x 32,5	7,5	4,5	Blue

		Ø cm	↑ cm	litr.	Farbe / Colour
88204	-	38,5	7,5	6,5	White
88208	-	38,5	7,5	6,5	Black
88212	-	38,5	7,5	6,5	Blue

Hinweis / Note / Remarque / Nota

Antihafbeschichtung ist nicht schnittfest. Keine scharfen oder spitzen Küchenhelfer verwenden. Ideal ist der Gebrauch von Küchenhelfer aus Holz oder Kunststoff.

Non-stick coating is not cut resistant. Do not use sharp or pointed kitchen utensils. Ideal is the use of kitchen helpers made of wood or plastic.

Le revêtement anti-adhésif n'est pas résistant aux coupures. N'utilisez pas d'ustensiles de cuisine tranchants ou pointus. L'idéal est d'utiliser des aides de cuisine en bois ou en plastique.

El recubrimiento antiadherente no es resistente al corte. No utilice utensilios de cocina afilados o puntiagudos. Lo ideal es el uso de utensilios de cocina de madera o plástico.



GN-Behälter Größen nach EN 631

Alle Behälter sind aus rostfreiem Chrom-Nickel-Edelstahl mit elektrolytisch polierter (seidenmatter) Oberfläche und somit perfekt geeignet für den professionellen Einsatz.

GN-container according to EN 631

All pans are made of chrome/nickel stainless steel with a surface polished by electrolysis (satin-matt) and therefore highly suitable for professional operation.

De conformidad con la norma europea EN 631.

Todos los contenedores están fabricados en acero inoxidable cromado/niquelado con su superficie (satinada) pulida por electrolisis lo que la hace altamente apropiado para el uso profesional.

Bacs GN- Conforme à la norme EN 631

Tous les bacs sont fabriqués en inox/chrome/nickel, surface polie électrolythique (satiné). Approprié pour usage professionnel.

Vorteile der rund geprägten U-Ecken:

- erhöhte Stabilität durch verstärktes Profil
- zielgerechtes und sauberes Ausgießen
- genaue Positionierung der GN-Behälter
- superleichtes Stapeln und Entstackeln
- kein Verklemmen der GN-Behälter
- hohe Stoßfestigkeit durch robuste Konstruktion
- ansprechendes Design und stilvoller Blickfang

Advantages of the round-shaped U-Corners:

- increased stability due to the unique construction
- clean lading and pouring
- exact positioning of the containers
- improved shock-resistance
- appealing design
- no seize of the containers

Ventajas de las esquinas en U:

Perfil reforzado que confiere mayor rigidez y resistencia a la cubeta, diseño para verter fácil y limpiamente, fáciles de apilar y desapilar sin que se claven entre sí, construcción más robusta y resistente a los golpes mecánicos, diseño elegante.

Avantages et fonctionnalité des angles en U:

Profil renforcé pour une meilleure consistance et rigidité du récipient, design qui facilite un versage propre et aisé, permet un empilage et désempliage faciles sans que les bacs restent coincés, meilleure résistance aux chocs mécaniques, seign élégant.

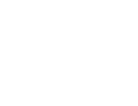
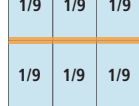
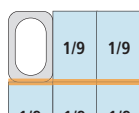
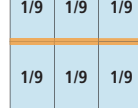
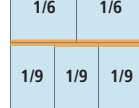
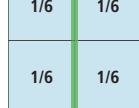
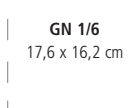
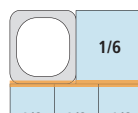
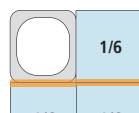
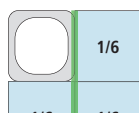
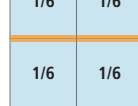
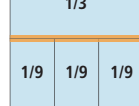
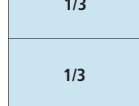
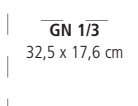
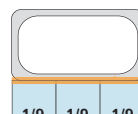
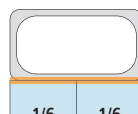
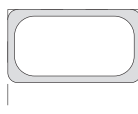
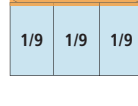
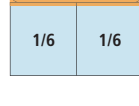
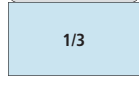
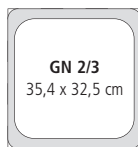
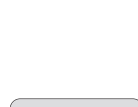
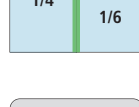
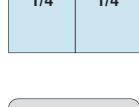
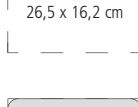
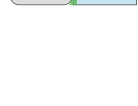
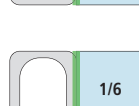
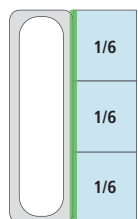
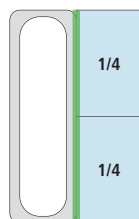
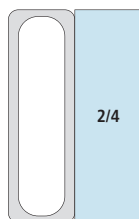
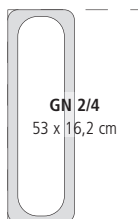
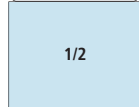
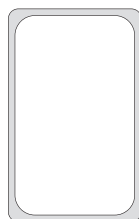

CHAFING DISH · GN CONTAINER · TRANSPORT



GN-Behälter

GN-container
GN cubetas
GN bacs



	GN	↓ mm	ltr.	cm
81000	2/1	20	5,0	53,0 x 65,0
81095	1/1	10	1,25	53,0 x 32,5
81100	1/1	20	2,5	53,0 x 32,5
81101	1/1	40	5,0	53,0 x 32,5
81109	1/1	55	6,5	53,0 x 32,5
81102	1/1	65	9,0	53,0 x 32,5
81104	1/1	100	13,25	53,0 x 32,5
81106	1/1	150	20,0	53,0 x 32,5
81108	1/1	200	25,0	53,0 x 32,5

	GN	↓ mm	ltr.	cm
81200	1/2	20	1,0	32,5 x 26,5
81201	1/2	40	2,0	32,5 x 26,5
81209	1/2	55	2,8	32,5 x 26,5
81202	1/2	65	4,0	32,5 x 26,5
81204	1/2	100	6,0	32,5 x 26,5
81206	1/2	150	8,75	32,5 x 26,5
81208	1/2	200	11,65	32,5 x 26,5

	GN	↓ mm	ltr.	cm
81300	1/3	20	0,75	32,5 x 17,6
81302	1/3	65	2,5	32,5 x 17,6
81304	1/3	100	4,0	32,5 x 17,6
81306	1/3	150	5,7	32,5 x 17,6
81308	1/3	200	7,0	32,5 x 17,6

	GN	↓ mm	ltr.	cm
81400	1/4	20	0,5	26,5 x 16,2
81401	1/4	40	1,0	26,5 x 16,2
81402	1/4	65	1,8	26,5 x 16,2
81404	1/4	100	2,8	26,5 x 16,2
81406	1/4	150	4,0	26,5 x 16,2
81408	1/4	200	5,5	26,5 x 16,2

	GN	↓ mm	ltr.	cm
81602	1/6	65	1,0	17,6 x 16,2
81604	1/6	100	1,6	17,6 x 16,2
81606	1/6	150	2,4	17,6 x 16,2
81608	1/6	200	3,0	17,6 x 16,2

	GN	↓ mm	ltr.	cm
81502	1/9	65	0,6	17,6 x 10,8
81504	1/9	100	1,0	17,6 x 10,8
81506	1/9	150	1,5	17,6 x 10,8

	GN	↓ mm	ltr.	cm
81700	2/3	20	1,5	35,4 x 32,5
81701	2/3	40	3,0	35,4 x 32,5
81702	2/3	65	5,5	35,4 x 32,5
81704	2/3	100	8,4	35,4 x 32,5
81706	2/3	150	12,5	35,4 x 32,5
81707	2/3	200	18,0	35,4 x 32,5

	GN	↓ mm	ltr.	cm
81800	2/4	20	1,2	53,0 x 16,2
81801	2/4	40	2,4	53,0 x 16,2
81802	2/4	65	3,6	53,0 x 16,2
81804	2/4	100	5,6	53,0 x 16,2
81806	2/4	150	8,7	53,0 x 16,2



perforierte GN-Behälter

perforated GN-container
cubetas GN perforadas
bacs GN perforés



	GN	↓ mm	cm
81911	1/1	40	53,0 x 32,5
81907	1/1	65	53,0 x 32,5
81908	1/1	100	53,0 x 32,5
81909	1/1	150	53,0 x 32,5
81910	1/1	200	53,0 x 32,5
81901	1/2	65	32,5 x 26,5
81902	1/2	100	32,5 x 26,5
81903	1/2	150	32,5 x 26,5
81904	1/2	200	32,5 x 26,5
81905	2/3	65	35,4 x 32,5
81906	2/3	100	35,4 x 32,5

NEW

2 x GN 1/4
26,5 x 16,2 cm

1 x GN 1/2
32,5 x 26,5 cm

4 ltr.

1,8 ltr.

1 x Adapter
31,5 cm

GN BEHÄLTER-SET
4-TEILIG - 65 MM TIEF

Lieferung in Farbverpackung
delivery in colour packaging

GN-Behälter Set, 4 teilig

GN-container, 4 pcs.
GN cubetas, set de 4
GN bacs, set de 4



bestehend aus: Edelstahlbehälter 1x GN 1/2 + 2x GN 1/4 + 1 Adapter

consisting of: stainless steel containers 1x GN 1/2 + 2x GN 1/4 + adapter

consiste en: cubetas de acero inoxidable 1x GN 1/2 + 2x GN 1/4 + adaptador

composé de: bacs en acier inox 1x GN 1/2 + 2x GN 1/4 + adaptateur

	GN	↓ mm	ltr.	cm	pcs
81850	1/2	65	4	32,5 x 26,5	1
	1/4	65	1,8	26,40 x 16,2	2
	Adapter			31,5	1



GN-Deckel

GN-lid
GN tapa
GN couvercle



ohne Löffelaussparung
without notched edge for spoons
sin agujero para cucharón
sans espace pour louche

	GN	cm
81195	1/1	53,0 x 32,5
81295	1/2	32,5 x 26,5
81395	1/3	32,5 x 17,6
81495	1/4	26,5 x 16,2
81695	1/6	17,6 x 16,2
81591	1/9	17,6 x 10,8
81795	2/3	35,4 x 32,5
81895	2/4	53,0 x 16,2



GN-Deckel

GN-lid
GN tapa
GN couvercle



mit Löffelaussparung
with notched edge for spoons
con agujero para cucharón
avec espace pour louche

	GN	cm
81191	1/1	53,0 x 32,5
81292	1/2	32,5 x 26,5
81391	1/3	32,5 x 17,6
81492	1/4	26,5 x 16,2
81692	1/6	17,6 x 16,2
81595	1/9	17,6 x 10,8
81791	2/3	35,4 x 32,5
81891	2/4	53,0 x 16,2



Die Löffelaussparung mit Prägung verhindert das Zurückfließen von Flüssigkeit auf dem Deckel in den Behälter.
The notche for spoon with embossing prevents liquid on the lid from flowing back into the container.

schwappsicherer Transport!



80023



80028



80029

nicht für Kombidämpfer geeignet!
max. 100°C

GN Transport-Steck-Deckel

GN-lid with silicone seal
GN tapa hermética con junta
GN couvercle hermétique avec joint



Silikondichtung, Griffmulde und Loch gegen Unterdruck,
nicht für Kombidämpfer geeignet

silicone joint, flat handle, vent to compensate
for pressure, not usable for steam oven

junta de silicona, asa empotrada, válvula para compensar
la presión, no se puede utilizar en hornos de vapor

joint silicone, anse encastrée, valve pour compenser la pression

	GN	cm
80023	1/1	53,0 x 32,5
80024	1/2	32,5 x 26,5
80025	1/3	32,5 x 17,6
80026	1/4	26,5 x 16,2
80027	1/6	17,6 x 16,2
80028	2/4	53,0 x 16,2
80029	2/3	35,4 x 32,5

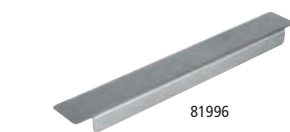

81996



81997



81999



81998

Adapter / Zwischensteg

adapter
adaptador
adaptateur



ermöglicht stabilen Halt von GN-Behältern im CD, rostfreier Chrom-Nickel-Edelstahl

for fixing GN pans, chrome / nickel stainless steel

para sujetar las cubetas GN, acero inox

support stable pour les bacs GN

	cm	
81996	15,9	längs bei GN 1/4 / lengthwise GN 1/4 longitud GN 1/4 / GN 1/4 dans la longueur
81997	17,6	längs bei GN 1/9 / lengthwise GN 1/9 longitud GN 1/9 / GN 1/9 dans la longueur
81999	32,5	quer bei GN 1/2 / crosswise GN 1/2 de ancho GN 1/2 / GN 1/2 dans la largeur
81998	53	längs bei GN 1/1 / lengthwise GN 1/1 longitud GN 1/1 / GN 1/1 dans la longueur



81117



81118

GN Abtropfgitter

GN-drainer
GN escurridor
GN égouttoir



Abtropfgitter aus Edelstahl für Gastronorm Behälter, passend für GN 1/1 und GN 1/2

stainless steel GN drainer for GN 1/1 + GN 1/2

escurridor GN de acero inoxidable para GN 1/1 + GN 1/2

égouttoir GN en acier inoxydable pour GN 1/1 + GN 1/2

	GN	cm	↑ cm
81117	1/1	45 x 25	1,5
81118	1/2	25 x 19	1,5

CHAFING DISH · GN CONTAINER · TRANSPORT



GN-Behälter aus Polycarbonat

GN-container polycarbonate
GN cubeta policarbonato
GN bac polycarbonate

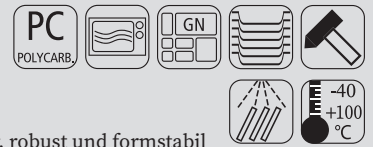

transparent: Inhalt gut erkennbar, Skalierung in Liter, robust und formstabil

transparent: content can be seen, liter scale, solid quality

transparente para ver el contenido, graduación en litros, alta calidad

transparent pour voir le contenu, graduation en litres, haute-qualité

	GN	↓ mm	ltr.	cm
82004	1/1	65	8,5	53 x 32,5
82006	1/1	100	13,0	53 x 32,5
82008	1/1	150	19,5	53 x 32,5
82010	1/1	200	26,0	53 x 32,5
	GN	↓ mm	ltr.	cm
82012	1/2	65	3,9	32,5 x 26,5
82014	1/2	100	5,9	32,5 x 26,5
82016	1/2	150	8,9	32,5 x 26,5
82017	1/2	200	11,8	32,5 x 26,5
	GN	↓ mm	ltr.	cm
82018	1/3	65	2,4	32,5 x 17,6
82020	1/3	100	3,6	32,5 x 17,6
82022	1/3	150	5,3	32,5 x 17,6
82023	1/3	200	7,0	32,5 x 17,6
	GN	↓ mm	ltr.	cm
82028	1/4	65	1,7	26,5 x 16,2
82030	1/4	100	2,5	26,5 x 16,2
82032	1/4	150	3,7	26,5 x 16,2
82034	1/4	200	4,8	26,5 x 16,2
	GN	↓ mm	ltr.	cm
82036	1/6	65	1,0	17,6 x 16,2
82038	1/6	100	1,5	17,6 x 16,2
82040	1/6	150	2,2	17,6 x 16,2
82042	1/6	200	2,8	17,6 x 16,2
	GN	↓ mm	ltr.	cm
82050	1/9	65	0,6	17,6 x 10,2
82051	1/9	100	1,0	17,6 x 10,2



GN-Deckel

GN-lid
GN tapa
GN couvercle



	GN	cm
82001	1/1	53,0 x 32,5
82013	1/2	32,5 x 26,5
82019	1/3	32,5 x 17,6
82029	1/4	26,5 x 16,2
82037	1/6	17,6 x 16,2
82059	1/9	17,6 x 10,8



GN Abtropfgitter

GN drainer
GN escurridor
GN égouttoir



	für GN	cm
82003	1/1	47,3 x 26,8
82005	1/2	26,8 x 20,8
82007	1/3	26,8 x 11,8



GN-Behälter aus Polypropylen

GN-container polypropylene
GN cubetas polipropileno
GN bacs polypropilène

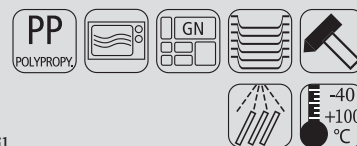

transparent: Skalierung in Liter, robust und formstabil

transparent: liter scale, solid quality

transparente: graduación en litros, alta calidad

transparent: graduation en litres, haute-qualité

	GN	↓ mm	ltr.	cm
82104	1/1	65	8,5	53 x 32,5
82106	1/1	100	13,0	53 x 32,5
82108	1/1	150	19,5	53 x 32,5
82110	1/1	200	26,0	53 x 32,5
<hr/>				
	GN	↓ mm	ltr.	cm
82112	1/2	65	3,9	32,5 x 26,5
82114	1/2	100	5,9	32,5 x 26,5
82116	1/2	150	8,9	32,5 x 26,5
82117	1/2	200	11,8	32,5 x 26,5
<hr/>				
	GN	↓ mm	ltr.	cm
82118	1/3	65	2,4	32,5 x 17,5
82120	1/3	100	3,6	32,5 x 17,5
82122	1/3	150	5,3	32,5 x 17,6
82123	1/3	200	7,0	32,5 x 17,6
<hr/>				
	GN	↓ mm	ltr.	cm
82128	1/4	65	1,7	26,5 x 16,2
82130	1/4	100	2,5	26,5 x 16,2
82132	1/4	150	3,7	26,5 x 16,2
82134	1/4	200	4,8	26,5 x 16,2
<hr/>				
	GN	↓ mm	ltr.	cm
82136	1/6	65	1,0	17,6 x 16,2
82138	1/6	100	1,5	17,6 x 16,2
82140	1/6	150	2,2	17,6 x 16,2
82142	1/6	200	2,8	17,6 x 16,2
<hr/>				
	GN	↓ mm	ltr.	cm
82150	1/9	65	0,6	17,6 x 10,8
82151	1/9	100	1,0	17,6 x 10,8



stapelbar
stackable



Skalierung
scaling



GN-Deckel

GN-lid
GN tapa
GN couvercle

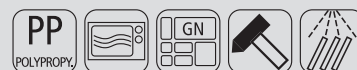

	GN	cm
82101	1/1	53,0 x 32,5
82113	1/2	32,5 x 26,5
82119	1/3	32,5 x 17,6
82129	1/4	26,5 x 16,2
82137	1/6	17,6 x 16,2
82159	1/9	17,6 x 10,8



GN-Konvektomatenblech

GN-convection oven trays
GN cubeta para hornos de convección
GN bac pour fours à convection



Oberfläche mit schwarzer Antihftbeschichtung, schwere Qualität

coated black non stick, heavy quality
interior con revestimiento antiadherente negro, alta calidad
revêtement intérieure antiadhérent noir, haute qualité

	GN	↓ mm	cm
88246	1/1	20	53 x 32,5



Backblech

baking sheet
bandeja pastelera
plaque à pâtisserie



gelocht Ø 3 mm, Materialstärke 1,5 mm, Silikon beschichtet, temperaturbeständig bis 240°C

perforated Ø 3 mm, coated with silicon, heat resistant up to 240°C
aluminio con revestimiento de silicona perforada, resistente hasta 240°
aluminium avec revêtement silicone, perforée, température maxi 240°

	GN	cm
88285	1/1	53 x 32,5

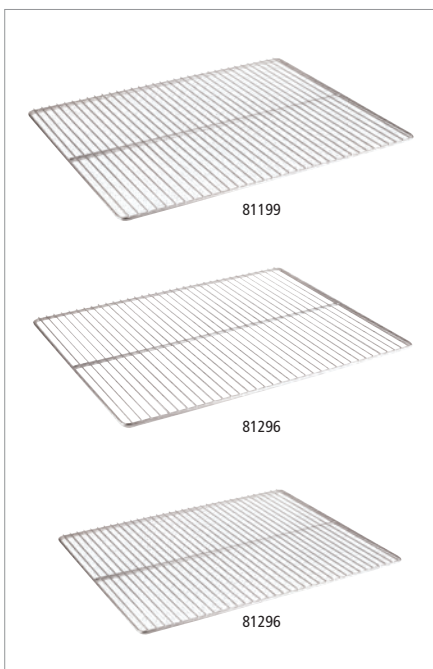

GN Roste

GN grid
GN rejilla
GN grille



elektrolytisch poliert, Drahtstärke 3 mm, Rahmendraht 6 mm, extra schwere Qualität

electro-polished, wire thickness 3 mm, frame wire 6 mm, extra heavy quality
inox pulido electrolítico, grosor alambre 3 mm, grosor marco 6 mm, calidad reforzada
inox poli électrolytique, fil 3 mm, cadre 6 mm, qualité renforcée

	GN	cm
81199	2/1	65,0 x 53,0
81198	1/1	53,0 x 32,5
81796	2/3	32,5 x 35,4
81296	1/2	32,5 x 26,5



GN 1/3 Bestecksammler

GN 1/3 container
GN 1/3 cubeta
GN 1/3 bac



mit 2 Haken zum Einhängen an Servier- oder Transportwagen

container with 2 hooks, to hang on trolleys for cutlery
cubeta con 2 ganchos para cubiertos, a colgar del carro
bac à couverts avec 2 crochets, à accrocher au chariot

	GN	↓ mm	cm
11978	1/3	150	32,5 x 17,5



GN-Behälter

GN-container
GN cubetas
GN bac

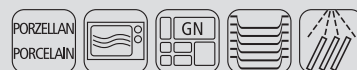

	GN	↓ mm	ltr.	cm
82100	1/1	60	7,1	53,0 x 32,5
82200	1/2	60	3,4	32,5 x 26,5
82300	1/3	60	2,0	32,5 x 17,6
82306	2/3	60	4,6	35,4 x 32,5
82301	2/4	60	3,0	53,0 x 16,2



GN Tablett „FRAMES“

GN tray
GN bandeja
GN plateau



	GN	↑ cm	cm
82355	1/1	2	53,0 x 32,5
82356	1/2	2	32,5 x 26,5
82357	1/3	2	32,5 x 17,6



GN Tablett

GN tray
GN bandeja
GN plateau



	GN	↑ cm	cm
82201	1/1	2,5	53,0 x 32,5
82202	1/2	2,5	32,5 x 26,5
82203	1/3	2,5	32,5 x 17,6
82204	2/4	2,5	53,0 x 16,2
82205	2/3	2,5	35,4 x 32,5



GN 1/1 Buffet-Set „CATERER“

GN 1/1 buffet set
GN 1/1 set de bufé
GN 1/1 set catering: plateau + cloche



2-teilig: Tablett + Haube, Tablett fixiert sich auf der Haube - kein Rutschen möglich
2 pcs. set: tray + cover, tray fixes itself on the cover and can not slip off
set de 2: bandeja + tapa, la bandeja encaja encima de la tapa para que no se deslice
set de 2: plateau GN 1/1 réf. + cloche spéciale empilement stable

	cm	↑ cm	GN	fits to
11195	53 x 32,5	10,5	1/1	82201, 82355

CHAFING DISH · GN CONTAINER · TRANSPORT

hot price



GN 2/4



GN 1/1



GN 1/2



GN 1/4



GN 1/6

GN-Behälter „ECOLINE“

GN container

GN cubeta

GN bac

mit Stapelnocke

with notching edge

con borde marcado para el apilado

avec rebord pour l'empilage



	GN	↓ mm	ltr.	cm	Farbe / Colour
83759	1/1	65	7,10	53,0 x 32,5	White
83755	2/4	65	3,00	53,0 x 16,2	White
83757	1/2	65	3,40	32,5 x 26,5	White
83753	1/3	65	2,00	32,5 x 17,6	White
83751	1/4	65	1,35	26,5 x 16,2	White
83749	1/6	65	0,80	17,6 x 16,2	White

	GN	↓ mm	ltr.	cm	Farbe / Colour
83758	1/1	65	7,10	53,0 x 32,5	Black
83754	2/4	65	3,00	53,0 x 16,2	Black
83756	1/2	65	3,40	32,5 x 26,5	Black
83752	1/3	65	2,00	32,5 x 17,6	Black
83750	1/4	65	1,35	26,5 x 16,2	Black
83748	1/6	65	0,80	17,6 x 16,2	Black

	GN	↓ mm	ltr.	cm	Farbe / Colour
84300	1/1	100	10,6	53,0 x 32,5	White
84302	2/4	100	4,3	53,0 x 16,2	White
84301	1/2	100	4,7	32,5 x 26,5	White
84303	1/3	100	2,7	32,5 x 17,6	White
84304	1/4	100	1,9	26,5 x 16,2	White
84305	1/6	100	1,0	17,6 x 16,2	White

	GN	↓ mm	ltr.	cm	Farbe / Colour
84306	1/1	100	10,6	53,0 x 32,5	Black
84308	2/4	100	4,3	53,0 x 16,2	Black
84307	1/2	100	4,7	32,5 x 26,5	Black
84309	1/3	100	2,7	32,5 x 17,6	Black
84310	1/4	100	1,9	26,5 x 16,2	Black
84311	1/6	100	1,0	17,6 x 16,2	Black



GN-Deckel

GN-lid

GN tapa

GN couvercle



	GN	cm
82001	1/1	53,0 x 32,5
82013	1/2	32,5 x 26,5
82019	1/3	32,5 x 17,6
82029	1/4	26,5 x 16,2
82037	1/6	17,6 x 16,2



83762

83763

GN-Behälter „HIGHLINE“

GN-container
GN cubeta
GN bac



mit Stapelnocke

with notching edge

con borde marcado para el apilado

avec rebord pour l'empilage

	GN	↓ mm	ltr.	cm
83772	1/1	65	7,10	53,0 x 32,5
83770	2/3	65	4,60	35,0 x 32,5
83768	1/2	65	3,40	32,5 x 26,5
83766	2/4	65	3,00	53,0 x 16,2
83764	1/3	65	2,00	32,5 x 17,6
83762	1/4	65	1,35	26,5 x 16,2
83760	1/6	65	0,80	17,6 x 16,2

	GN	↓ mm	ltr.	cm
83773	1/1	100	11,0	53,0 x 32,5
83769	1/2	100	5,50	32,5 x 26,5
83765	1/3	100	3,15	32,5 x 17,6
83763	1/4	100	2,20	26,5 x 16,2
83761	1/6	100	1,25	17,6 x 16,2



83768

11302

GN 1/1, 2-tlg. Set: Tablett + Haube



**System-Haube für stapelbare Tablett
wie 11300, 11290 oder 11295**

GN 1/1 Buffet-Set „HOCHSTAPLER“

GN 1/1 buffet set

GN 1/1 set de bufé

GN 1/1 kit catering plateau + cloche



2-teilig: Tablett + Haube, Tablett fixiert sich auf der Haube - kein Rutschen möglich

2 pcs. set: tray + cover, tray fixes itself on the cover and can not slip off

set de 2 piezas: bandeja + tapa, la bandeja encaja encima de la tapa para que no se deslice

ensemble de 2 pièces: plateau GN 1/1 réf. + cloche spéciale empilement stable

	cm	↑ cm	GN
11302	53 x 32,5	10,5	1/1

CHAFING DISH · GN CONTAINER · TRANSPORT



Servier- / Transportwagen

serving trolley
carro de servicio
chariot de service



Gestell aus Vierkantröhr 25 x 25 mm, Ablagefläche innen 84 x 44,5 cm, Bodenfläche 90 x 50 cm, auf Unterseite schalldämmend beschichtet, Abstand zwischen den Böden 28 cm / 29 cm, mit 4 Lenkrollen Ø 12,5 cm, alle mit Feststellern, Lieferung demontiert, einfache Montage, Tragfähigkeit 33 kg je Boden

frame rectangular bar 25 x 25 mm, shelf board inside 84 x 44,5 cm, shelf board outside 90 x 50 cm, undersurface coated sound-damping, distance between the boards 28 cm / 29 cm, with 4 swivel wheels Ø 12,5 cm, all with brakes, unassembled, simple assembly, max load 33 kg per shelf

estructura tubo cuadrado 25 x 25 mm, útiles int. por piso 84 x 44,5 cm. ext. al suelo 90 x 50 cm revestimiento para absorber ruidos distancia entre pisos 28 cm / 29 cm, 4 ruedas giratorias 12,5 cm, con frenos, se sirve desmontado, montaje fácil, carga máx. 33 kg por piso

structure en tube carré 25x25 mm, 3 niveaux dimensions utiles 84x44,5 cm, encombrement au sol 90x50 cm, avec revêtement en partie inférieure pour absorber le bruit, distance entre niveaux 28 cm / 29 cm, 4 roues pivotantes 12,5 cm, avec frein, livré démonté, montage aisé, max. 33 kg de charge par niveau

	cm	↑ cm
71440	96 x 50	94



Servier- / Transportwagen

service trolley
carro de servicio
chariot de service



mit 3 Borden, Bordmaße ca. 83 x 51 cm, Abstand zwischen den Borden ca. 26 cm, Tragfähigkeit 120 kg, 4 Lenkrollen, davon 2 feststellbar, Lieferung demontiert, einfache Montage

with 3 trays, trays approx. 83 x 51 cm, size between the trays approx. 26 cm, total load capacity 120 kg, 4 wheels with 2 brakes, unassembled, simple assembly

con 3 bandejas inox mate, aprox. 83 x 51 cm, la medida entre bandejas aprox. 26 cm capacidad total 120 kg, 4 ruedas con 2 frenos, construcción robusta, montaje fácil

3 niveaux, approx. 83x51 cm chacun, distance entre niveaux 26 cm, capacité maxi 120 kg au total, 4 roues dont 2 avec frein, construction robuste, montage facile

	cm	↑ cm
11979	91 x 59	93



Servier- / Transportwagen

service trolley
carro de servicio
chariot de service



mit 2 Borden, Bordmaße ca. 83 x 51 cm, Abstand zwischen den Borden ca. 56 cm, Tragfähigkeit 80 kg, 4 Lenkrollen, davon 2 feststellbar, Lieferung demontiert, einfache Montage

with 2 trays, trays approx. 83 x 51 cm, size between the trays approx. 56 cm, total load capacity 80 kg, 4 wheels with 2 brakes, unassembled, simple assembly

con 2 bandejas de acero inoxidable mate, aprox. 83 x 51 cm, la medida entre bandejas aprox. 56 cm, capacidad total 80 kg, 4 ruedas, con 2 frenos, construcción robusta, montaje fácil

2 niveaux, approx. 83x51 cm chacun, distance entre niveaux 56 cm, capacité maxi 80 kg au total, 4 roues dont 2 avec frein, construction robuste, montage facile

	cm	↑ cm
11977	91 x 59	93



GN 1/1 Regalwagen

GN 1/1 trolley
GN 1/1 carro
GN 1/1 chariot



mit 15 Doppelauflegeschieben, zum Transport von bis zu 30 GN-Tablets GN 1/2 oder 15 GN-Behältern bis GN 1/1 (Längseinschub), bei einem Stapelabstand von 75 mm, mit 4 Lenkrollen, 2 mit Feststellern, Tragfähigkeit 100 kg

15 double bars, for transporting up to 30 trays GN 1/2 or 15 GN containers up to GN 1/1 (lengthwise insertion), size between the trays 75 mm, with 4 swivel wheels, 2 with brakes, max. load 100 kg

15 raíles de soporte dobles, para transportar hasta 30 bandejas GN 1/2 o 15 cubetas GN hasta GN 1/1 (inserción longitudinal), distancia entre las bandejas de 75 mm, con 4 ruedas giratorias, 2 con freno, carga máxima de 100 kg

15 doubles rails de support, pour transporter jusqu'à 30 plateaux GN 1/2 ou 15 bacs GN jusqu'à GN 1/1 (insertion longitudinale), distance entre les plateaux 75 mm, avec 4 roues pivotantes, 2 avec frein, capacité de charge 100 kg

	cm	↑ cm
71441	55 x 38,5	173,5



mit beidseitiger Kipp- und Durchschubsicherung
with tilt and push-through protection on both sides



Servier- / Transportwagen

serving trolley
carro de servicio
chariot de service



Aluminiumrahmen, 3 Böden, Abstand zwischen den Böden 31 cm, mit 4 Lenkrollen, alle mit Feststellern, Tragfähigkeit: ca. 80 kg je Boden, 240 kg insgesamt, demontiert, einfache Montage, Lieferung ohne Container und Dekoration

frame aluminium, 3 shelves, distance between shelves 31 cm, 4 swivel wheels, all equipped with brakes, max. load per shelf 80 kg, 240 kg total, demounted, easy to mount, delivery without containers and decoration

marco aluminio, 3 pisos, distancia entre cada piso 31 cm, 4 ruedas giratorias, las 4 con frenos, carga máxima por bandeja 80 kg, 240 kg en total, se sirve desmontado, fácil de montar (se entrega sin contenedores ni decoración)

chassis aluminium, 3 étages, distance entre niveaux 31 cm, 4 roues pivotantes, toutes avec frein, charge maximum 80 kg par niveau, 240 kg au total, livré démonté, montage facile (livré sans récipients ni décoration)

	cm	↑ cm	
11945	108 x 50	96	without containers



Container

container
contenedor
récipient



zum Einhängen, passend zum Servier- / Transportwagen 11945

to hang up, suitable serving trolley 11945

para colgar, adaptado para el carro ref. 11945

à suspendre, pour chariot de service 11945

	cm	↑ cm	ltr.
11946	33 x 23	56,5	42
11947	33 x 23	17,5	13

CHAFING DISH · GN CONTAINER · TRANSPORT



GN 1/1 Besteckbehälter

GN 1/1 dispenser GN
GN 1/1 dispensador de cubiertos
GN 1/1 bac à couverts



in Handarbeit geflochten, 4 Mulden, Kunststoff-Geflecht, Drahtgestell, braun-schwarz
wickerwork, 4 compartments, with reinforced chromed wire structure, brown-black
cesta trensada a mano, 4 compartimentos, de plástico, con bastidor cromado reforzado, marrón oscuro
corbeille tressée à main, 4 compartiments, en plastique, cadre acier chromé renforcé, couleur marron foncé

	cm	↑ cm	Farbe / Colour
11966	53 x 32,5	9	



GN 1/1 Besteckbehälter „BUFFET“

GN 1/1 cutlery dispenser
GN 1/1 dispensador de cubiertos
GN 1/1 bac à couverts



4 Mulden, Kunststoff-Geflecht, Drahtgestell, beige
4 troughs, wickerwork, wire, beige
4 huecos, trabajo de cestería
4 compartiments, plastique tressé, cadre acier chromé renforcé, couleur osier naturel

	cm	↑ cm	Farbe / Colour
11965	53 x 32,5	10	



GN 1/1 Besteckbehälter

GN 1/1 cutlery tray / box stand
GN 1/1 dispensador de cubiertos
GN 1/1 bac à couverts



	cm	↑ cm	Farbe / Colour
11955	53 x 32,5	10	



GN 1/1 Besteckkasten

cutlery box GN 1/1
GN 1/1 dispensador de cubiertos
GN 1/1 bac à couverts



	cm	↑ cm	Farbe / Colour
11960	53 x 32,5	10	



GN 1/1 Besteckbehälter

GN 1/1 cutlery bin
GN 1/1 recipiente para cubiertos
GN 1/1 récipients pour couverts



	cm	↑ cm	Farbe / Colour
11954	53 x 32,5	10	
11955	53 x 32,5	10	



Besteckbehälter
 cutlery basket
 recipiente para cubiertos
 récipients pour couverts

4 Löcher inkl. 4 Edelstahl Köcher
 4 holes incl. 4 stainless baskets
 4 agujeros, incl. 4 cestas de acero
 4 places, avec 4 corbeille inox



	cm	↑ cm	Farbe / Colour
93321	27 x 27	15	■



Besteckbehälter
 cutlery basket
 dispensador de cubiertos
 présentoir à couverts

matt poliert
 satin polished finish
 inox mate (sin cubiertos)
 inox mat



	cm	↑ cm	
11994	26,0 x 30 Ø 10	20	4 Löcher inkl. Köcher (Kunststoff) 4 holes incl. dispensers (plastic) 4 agujeros incl. dispensador plástico 4 places, avec 4 récipients (plastique)
11997	37,5 x 30 Ø 10	20	6 Löcher ohne Köcher 6 holes without dispensers 6 agujeros sin dispensador de plástico 6 places, sans récipients



11998
 Köcher weiß / PE white

Besteckköcher
 cutlery basket
 cesta para cubiertos
 corbeille à couverts



	Ø cm	↑ cm	
11998	9,7	13,7	Kunststoff weiß / white plastic plástico blanco / plastique blanc



11999
 Köcher Edelstahl / stainless steel

Besteckköcher
 cutlery basket
 cesta para cubiertos
 corbeille à couverts



	Ø cm	↑ cm	
11999	9,7	13,7	matt poliert / satin polished finish acero inoxidable / inox

CHAFING DISH · GN CONTAINER · TRANSPORT



Teig- und Pizzaballenbehälter dough and pizza ball container recipiente para masa y bolas de pizza récipient à pâte et boules à pizza



Innenmaß 56,5 x 36,5 cm, H: 7 cm
inner dimension 56,5 x 36,5 cm, H: 7 cm
medida interior 56,5 x 36,5 cm, H: 7 cm
dimension intérieure 56,5 x 36,5 cm, H: 7 cm

	cm	↑ cm	ltr.
82440	60 x 40	7,5	14



stapelbar
stackable

passender Deckel / fitting lid / tapa adecuada / couvercle approprié

	cm	↑ cm	
82441	60 x 40	1	



Eier-Box eggs box caja para huevos boîte à oeufs



mit luftdichtem Deckel, für 4 Lagen à 30 Eier, Lieferung inkl. 8 Lagen, Größe Lage: 28 x 28 cm
with airtight cover, capacity: 4 trays of 30 eggs, delivery with 8 trays, size of tray: 28 x 28 cm
capacidad para 4 bandejas de 30 huevos, tapa hermética, se entrega con 8 bandejas, formato bandejas 28 x 28 cm, apto para lavavajillas
pour 4 plateaux de 30 oeufs chacun, apte pour 4 plateaux plats, couvercle hermétique, livré avec 8 plateaux, dimension plateau 28x28 cm, lavable en lave-vaisselle

	cm	↑ cm	GN
82419	35,4 x 32,5	20	2/3

10 Lagen / 10 trays / 10 bandejas / 10 plateaux

82420



25 ltr.

stabile Ausführung
robust

Wanne container cubeta bac



	cm	↑ cm	ltr.
11940	61 x 44	15	25



20 ltr.

Wanne container cubeta bac



	cm	↑ cm	ltr.
11950	55 x 42	14	20

NEW



10,5 ltr.

30075



17 ltr.

30078

Profi-Eimer

bucket
cubo
seau



mit Ausgießer und geprägter Maßskalierung innen
with spout and embossed dimension scaling inside
con pico y escala de medición en relieve en el interior
avec bec verseur et échelle de mesure en relief à l'intérieur

	Ø cm	↑ cm	ltr.	Farbe / Colour
30075	28,5	28,5	10,5	White
30076	33,0	32,0	17,0	White
30077	28,5	28,5	10,5	Black
30078	33,0	32,0	17,0	Black



30077



30076



mit Griff
with handle

Maßskalierung innen
dimension scaling
inside

Auslaufnase für sicheres Handling
discharge nose for safe handling

NEW

Ø 6 cm



30065

Ø 12 cm



30068

Ø 17 cm

inkl. Sieb
incl. strainer



30070

Trichter „PROFI“

funnel
embudo
entonnoir

mit Öse
with eyelet
con ojal
avec œillet



	Ø cm	Ø mm Durchlass	
30065	6	8	
30066	8	11	
30067	10	12	
30068	12	12	
30069	14	15	
30070	17	17	mit Sieb / incl. strainer
30071	21	20	mit Sieb / incl. strainer



30066



30065



30071

erleichtert das Einfüllen
facilitates filling

Anwendungsmöglichkeit
applicability

mit einsetzbarem Sieb
incl. insertable strainer





Bar, Café Drinkware



Flaschenkühler „MOSCOW MULE“

bottle cooler
enfriador de botellas
rafraîchisseur de bouteilles

Edelstahl-Flaschenkühler, Antik-Kupfer-Look
stainless steel cooler, copper antique look
enfriador de acero inoxidable, cobre estilo antiguo
rafraîchisseur en acier inox, cuivre style antique



	Ø cm	↑ cm	ltr.	
93330	20	21	5	copper-antique-hammered



Wein- / Sektkühler „TROPHY“

wine / champagne bowl
cubitera para vino y cava
seau à vin ou champagne

hochglanzpoliert, mit Griffen, Fuß Ø 18,5 cm,
mirror polished finish, with handles, foot Ø 18,5 cm
pulido brillante, 2 asas, pie ø 18,5 cm
brillant, 2 anses, pied ø 18,5 cm



	Ø cm	↑ cm	ltr.	
36092	23	24	5	stainless-steel
36093	23	24	5	copper-look



Wein- / Sektkühler

wine / champagne bowl
cubitera para vino y cava
seau à vin ou champagne

innen mattiert, außen hochglanzpoliert, mit massiven Knopf-Griffen,
extra stabiler ingerollter Rand, schwere Ausführung
outside mirror polished finish, inside satin polished finish,
with solid knob handles, rolled edge, heavy quality
acabado pulido brillante, asas de botón robustas, borde redondeado, alta calidad
brillant, 2 poignées robuste en forme de bouton, bord arrondi, haute qualité



	Ø cm	↑ cm	ltr.
36028	21,5 / 16	22	4



Wein- / Sektkühler

wine / champagne bowl
cubitera para vino y cava
seau à vin ou champagne

innen mattiert, außen poliert, mit massiven Griffen, Rand ingerollt
outside mirror polished finish, inside satin polished finish, with massive handles, rolled edge
pulido mate, 2 asas macizas, borde redondeado
finition mate, 2 anses massives, bord rond



	Ø cm	↑ cm	ltr.
36025	21 / 15	21	3,5



Mini-Eiseimer / Mini-Sektkühler

ice bucket
cubitera clásica
seau à glaçons classique



	Ø cm	↑ cm	ltr.
36003	10,5	10	0,5
36004	13,0	13	1,0



Wein- / Sektkühler

wine / champagne bowl
cubitera para vino y cava
seau à vin ou champagne



aussen hochglanzpoliert, innen matt poliert, mit Ring-Griffen
outside mirror polished finish, inside satin polished finish, with ring handles
exterior pulido brillante, interior efecto satinado con 2 asas anillos
extérieur brillant, intérieur satin, avec 2 anneaux

	Ø cm	↑ cm	ltr.
36020	20 / 15	19	3



Wein- / Sektkühler

wine / champagne bowl
cubitera para vino y cava
seau à vin ou champagne



matt poliert, Hohlgriffe
satin polished finish, hollow handles
acabado pulido satinado, con asas huecas
finition mate, 2 boutons creux

	Ø cm	↑ cm	ltr.
36021	20 / 15	20,5	4



Wein- / Sektkühler „HAMMERSCHLAG“

wine / champagne bowl
cubitera para vino y cava
seau à vin ou champagne



hochglanzpoliert, mit massiven Ring-Griffen, eingerollter Rand
mirror polished finish, with solid ring handles, rolled edge, hammered
acabado pulido brillante, con 2 anillos macizos, borde redondeado, repujado
brillant, 2 anneaux massifs, bord arrondi, surface martelée

	Ø cm	↑ cm	ltr.
36026	21 / 17	21,5	4



Wein- / Sektkühler

wine / champagne bowl
cubitera para vino y cava
seau à vin ou champagne



glasklarer Rand, transparent gefrostet
edge transparent, body transparent frosted
borde transparente, cuerpo transparente efecto glaseado
bord transparent, corps finition mate

	Ø cm	↑ cm	ltr.
36066	22 / 14	23	4



Wein- / Sektkühler

wine / champagne bowl
cubitera para vino y cava
seau à vin ou champagne



glasklar, mit Tragegriff
transparent, handle on the side
transparente, con un asa en el lateral
transparent, avec poignée

	cm	↑ cm	ltr.
36055	23 x 22	27,5	3



Ständer für Wein- / Sektkühler

stand for wine / champagne bowl
pie porta champañera / vino
pied pour seau à champagne / vin



hochglanzpoliert, schwerer standsicherer Fuß, Innendurchmesser der Schale Ø 15 cm
mirror polished finish, heavy foot, inner bowl Ø 15 cm
acabado pulido efecto brillante, bol interior de Ø 15 cm
brillant, intérieur support Ø 15 cm

	Ø cm	↑ cm
36068	15 / 28	68



Ständer für Wein- / Sektkühler

stand for wine / champagne bowl
pie porta champañera / vino
pied pour seau à champagne / vin



hochglanzpoliert, schwerer standsicherer Fuß, Innendurchmesser der Schale Ø 17,5 cm
mirror polished finish, heavy foot, inner bowl Ø 17,5 cm
acabado pulido efecto brillante, bol interior de Ø 17,5 cm
brillant, intérieur support Ø 17,5 cm

	Ø cm	↑ cm
36069	17,5 / 26,5	73



Wein- / Sektkühler no. 36028
wine / champagne bowl no. 36028
cubitera para vino y cava no. 36028
seau à vin ou champagne no. 36028



Tischhalterung für Sektkühler

champagne bucket table holder
soporte champañera universal
porte-seau à champagne



aus 8 mm starkem Stahldraht, passen zu allen lieferbaren Sektkühlern, innen Ø-Ring: 18 cm
8 mm chrome plated wire, suitable for all available champagne buckets, inner ring Ø 18 cm
alambre cromado 8 mm, para todas las champañeras, anillo interior Ø 18 cm
fil chromé 8 mm, pour tous les seaux à champagne, anneau intérieur Ø 18 cm

	cm	↑ cm
30332	49 x 20	17



Gläserische

glass rack
rack de copas
rack porte-verres



aus 6 mm Draht, Metall verchromt, Wand- und Deckenmontage möglich
6 mm chrome plated wire, can be mounted under a shelf or on the wall
alambre cromado de 6 mm, puede instalarse bajo una estantería o en la pared
fil chromé de 6 mm, à installer sous une étagère ou contre un mur

	cm	↑ cm	for glasses	Farbe / Colour
93398	29,5 x 32	6	12	chrome
93399	29,5 x 32	6	12	black
93400	45,0 x 32	6	20	chrome



Flaschenkühler

bottle cooler
enfriador de botella
rafraîchisseur de bouteille

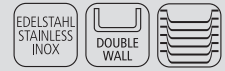

doppelwandig für beste Isolierung, außen Hammerschlag-Optik
double-walled for best insulation, outside: hammered surface
doble pared para un mejor aislamiento, exterior: aspecto martillado
double paroi pour une meilleur isolation, extérieur: surface martelée

	Ø cm	↑ cm	ltr.	Farbe / Colour
36120	33	20	8	stainless
36121	33	20	8	copper-look



Präsentationsmöglichkeit
presentation examples



Wein- / Sektkühler

wine / champagne bowl
cubitera para vino y cava
seau à vin ou champagne



gehämmerte Oberfläche mit 2 seitlichen Eingriffen
hammered surface with 2 handles on the side
superficie martillada con 2 asas
surface martelée avec 2 poignées

	cm	↑ cm	ltr.	Farbe / Colour
36111	30 x 23,5	23	7	copper-look



Wein- / Sektkühler

wine / champagne bowl
cubitera para vino y cava
seau à vin ou champagne



gehämmerte Oberfläche mit 2 seitlichen Eingriffen
hammered surface with 2 handles on the side
superficie martillada con 2 asas
surface martelée avec 2 poignées

	cm	↑ cm	ltr.	Farbe / Colour
36112	30 x 23,5	23	7	gunmetal-look



Getränkewanne „TIN“

beverage tub
barreño botellines
bassine à glace



Metall verzinkt, mit Kunststoffeinsatz, mit massiven Ring-Griffen
galvanised metal, with plastic insert, with solid ring handles
metal galvanizado, con inserto de plástico, con 2 anillos macizos
métal galvanisé, avec insert en plastique, 2 anneaux massifs



	cm	↑ cm	ltr.
36095	40 x 28	22	11
36096	50 x 32	23	18

2 sizes available with ring handles



Getränkewanne „TIN“

beverage tub
barreño botellines
bassine à glace



Metall verzinkt, mit Kunststoffeinsatz, mit massiven Ring-Griffen
galvanised metal, with plastic insert, with solid ring handles
metal galvanizado, con inserto de plástico, con 2 anillos macizos
métal galvanisé, avec insert en plastique, 2 anneaux massifs

	cm	↑ cm	ltr.	Farbe / Colour
36100	40 x 28	22	11	copper-look
36101	40 x 28	22	11	black-metal-look



mit Kunststoffeinsatz
with plastic insert
con inserto de plástico
avec insert en plastique



Kreidestift zum Beschriften
chalk marker for writing
S. 348



Champagnerkühler

champagne bowl
cubo champañera
seau à champagne



hochglanzpoliert, Rand matt poliert
mirror polished finish, edge satin polished finish
acabado pulido brillante, borde satinado
brillant, bord mat

	Ø cm	↑ cm	ltr.
36046	45 / 21	23	12



Champagnerkühler

champagne bowl
cubo champañera
seau à champagne



hochglanzpoliert
mirror polished finish
acabado efecto brillante
brillant

	Ø cm	↑ cm	ltr.
36045	40,5 / 27,5	22,5	13,5



Champagnerkühler

champagne bowl
cubo champañera
seau à champagne



außen hochglanzpoliert, innen matt poliert, mit vergoldeten Griffen
outside mirror polished finish, inside satin polished finish, with gold plated handles
exterior pulido brillante, interior satinado
extérieur brillant, intérieur satin

	Ø cm	↑ cm	ltr.
36047	42 / 27	28	20



Flaschenkühler „BRIDGE“

bottle cooler
enfriador de botellas
rafraîchisseur de bouteilles

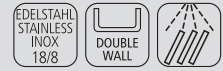

doppelwandig für beste Isolierung, außen poliert, innen mattiert

double wall cooler keeps the temp. for a long time, outs. mirror polished, inside matt finish
champañera inox de doble pared, interior mate, exterior brillante
seau inox double paroi, maintient le froid plus longt., intérieur mat, extérieur poli brillant

	Ø cm	↑ cm	ltr.
36077	31	19	10



Konferenzkühler „BRIDGE“ no. 13985

bottle cooler no. 13985
enfriador no. 13985
rafraîchisseur no. 13985



Champagnerkühler

champagne bowl
cubo champañera
seau à champagne



hochglanzpoliert, doppelwandig für beste Isolierung

mirror polished finish, double wall cooler keeps the temp. for a long time
acabado pulido brillante con champañera inox de doble pared
brillant, double paroi, maintient le froid plus longt.

	Ø cm	↑ cm	ltr.
36044	44 / 25	24	10,5



Wein- / Sektkühler

wine / champagne bowl
cubitera para vino y cava
seau à vin ou champagne



mit seitlichen Griffen, transparent

with lateral handles, transparent
con asas laterales
avec poignées latérales

	cm	↑ cm	ltr.
36087	32 x 21,5	24,5	7



Wein- / Sektkühler

wine / champagne bowl
cubitera para vino y cava
seau à vin ou champagne



glasklar, für bis zu 6 Flaschen geeignet

transparent, suitable for up to 6 bottles
transparente, para máximo 6 botellas
transparent, maxi 6 bouteilles

	cm	↑ cm	ltr.
36057	47 x 28	23	10



36048

Wein- / Sektkühler
 wine / champagne bowl
 cubitera para vino y cava
 seau à vin ou champagne



mit 2 seitlichen Eingriffen
 with 2 handles on the side
 con 2 asas
 avec 2 poignées

	cm	↑ cm	ltr.
36048	35 x 27	25,5	6
36052	27 x 20	21	3



36054

Wein- / Sektkühler
 wine / champagne bowl
 cubitera para vino y cava
 seau à vin ou champagne



mit 2 seitlichen Eingriffen
 with 2 handles on the side
 con 2 asas
 avec 2 poignées

	cm	↑ cm	ltr.	Farbe / Colour
36054	35 x 27	25,5	6	■
36053	27 x 20	21,0	3	■



Wein- / Sektkühler
 wine / champagne bowl
 cubitera para vino y cava
 seau à vin ou champagne



glasklar, für zwei Flaschen
 clear, for two bottles
 transparente, para 2 botellas
 transparent, pour 2 bouteilles

	cm	↑ cm	ltr.
36056	30,5 x 21,5	26	4



Flaschenkühler
 bottle cooler
 enfriador de botella
 rafraîchisseur de bouteille



matt poliert, doppelwandig für beste Isolierung
 satin polished finish, double wall cooler keeps the temperature for a long time,
 for 0,7 - 1,5 ltr. bottles
 acero inoxidable mate con doble pared para mantener el frio largo tiempo,
 para botellas de 0,7 - 1,5 ltr.
 inox mat, double paroi pour une meilleure conservation de la température,
 pour bouteilles de 0,7 à 1,5 l.

	Ø cm	↑ cm
36038	12,5 / 10	19



Flaschenkühler „COPPER“

bottle cooler
enfriador de botella
rafraîchisseur de bouteille

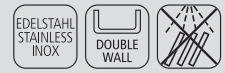

Hammerschlag-Optik, doppelwandig für beste Isolierung, für 0,7 - 1,5 Liter-Flaschen
double wall cooler keeps the temperature for a long time, hammered look, for 0,7 - 1,5 ltr. bottles
doble pared para mantener el frío largo tiempo, para botellas de 0,7 - 1,5 ltr.
double paroi pour une meilleure conservation de la température, pour bouteilles de 0,7 à 1,5 l.

	Ø cm	↑ cm	Farbe / Colour
36074	12 / 10	20	



1:1 Oberflächenansicht
1:1 structural view



Flaschenkühler

bottle cooler
enfriador de botella
rafraîchisseur de bouteille



matt poliert, doppelwandig für beste Isolierung, für 0,7 - 1,5 Liter-Flaschen
satin polished finish, double wall cooler keeps the temperature for a long time, for 0,7 - 1,5 ltr. bottles
acero inoxidable mate con doble pared para mantener el frío largo tiempo, para botellas de 0,7 - 1,5 ltr.
inox mat, double paroi pour une meilleure conservation de la température, pour bouteilles de 0,7 à 1,5 l.

	Ø cm	↑ cm
36030	12 / 10	20



hot price

36032

36034

Flaschenkühler

bottle cooler
enfriador de botella
rafraîchisseur de bouteille



transparent, doppelwandig für beste Isolierung, mit Chromrand
transparent, double wall cooler keeps the temperature for a long time, with chrome edge
transpar., doble pared mantiene la temperaruta por largo tiempo, borde superior cromado
transparent, bord chromé brillant, double paroi pour maintien en température

	Ø cm	↑ cm	Farbe / Colour
36032	12 / 10	23	
36034	12 / 10	23	



Flaschenkühler „PURE“

bottle cooler
enfriador de botella
rafraîchisseur de bouteille



doppelwandig für beste Isolierung, glasklar
double wall cooler keeps the temperature for a long time, clear
doble pared mantiene la temperaruta por largo tiempo, transparente
double paroi pour maintien en température, transparent

	Ø cm	↑ cm
36063	13,5 / 10,5	23



Flaschenkühler „CRYSTAL“

bottle cooler
enfriador de botella
rafraîchisseur de bouteille



doppelwandig für beste Isolierung, glasklar

double wall cooler keeps the temperature for a long time, clear
doble pared mantiene la temperatura por largo tiempo, transparente
double paroi pour maintien en température, transparent

	∅ cm	↑ cm
36062	13,5 / 10,5	23



Flaschenkühler

bottle cooler
enfriador de botella
rafraîchisseur de bouteille



Rand matt poliert, doppelwandig für beste Isolierung, für 0,7 - 1,5 Liter Flaschen

satin polished finish edge, double wall cooler keeps the temperature for a long time, for 0,7 - 1,5 ltr. bottles
borde pulido satinado, con doble pared para mantener más tiempo la temperatura para botellas de 0,7 a 1,5 l.
bord métallique mat, double paroi pour excellente conservation de la température, pour bouteilles de 0,7 à 1,5 l.

	∅ cm	↑ cm
36050	11,5 / 9,5	23



Flaschenkühler ELEMENT“

bottle cooler
enfriador de botella
rafraîchisseur de bouteille



Beton, mit möbelschonender Unterseite
concrete, with non-scratching undersurface
hormigón, con base anti rayaduras
béton, avec base revêtement antirayures

	cm	↑ cm	Farbe / Colour
36090	12 / 10	19	

36090



Flaschenkühler „ELEMENT BLACK“

bottle cooler
enfriador de botella
rafraîchisseur de bouteille



Beton, mit möbelschonender Unterseite
concrete, with non-scratching undersurface
hormigón, con base anti rayaduras
béton, avec base revêtement antirayures

	cm	↑ cm	Farbe / Colour
36099	12 / 10	19	

36099



Kühlmanschette „CHAMPAGNE“

cool collar
funda de frío
housse isotherme



für Sekt- / Champagnerflaschen, einfach im Gefrierfach einfrieren, komplette Flasche wird in 5 Min. auf angenehme Trinktemperatur gekühlt, außen reißfestes Stoffgewebe, innen Kunststoff mit Kühlgel gefüllt, unbegrenzt wiederverwendbar

for bottles of champagne, simply to freeze in the freezer, complete bottles will be cooled down in only 5 minutes, tearproof cloth outside, plastic filled with gel inside, unlimited reusable

para botellas de cava o champán simplemente congelándola en el congelador, la botella entera se enfriará en 5 minutos, funda de plástico muy robusta, rellena con un gel congelante reutilizable ilimitadamente

pour bouteilles de vin ou champagne, la housse est préalablement stockée au congélateur, où elle accumule le froid, ensuite elle refroidit une bouteille en quelques minutes, plastique résistant, contient un liquide congelant, à réutiliser de façon illimitée

	Ø cm	↑ cm
36075	11	18



Pitcher

pitcher
jarra
pichet



	Ø cm	↑ cm	ltr.
93105	13	21	1,5



Weinflaschenhalter

winebottle-stand
soporte para botella de vino
porte-bouteille



	cm	↑ cm
30333	22 x 6	20,5



Flaschenträger

bottle rack
porta botellas
porte-bouteilles



für 6 Flaschen, Ring Ø 9,5 cm

for 6 bottles, ring Ø 9,5 cm

para 6 botellas, Ø 9,5 cm

pour 6 bouteilles, Ø 9,5 cm

	cm	↑ cm
00630	32 x 21,5	32,5



Bierglasträger

beer rack
porta vasos de cerveza
porte verres à bière



für Glasgrößen 0,2 - 0,3 Liter, für 10 Gläser, Ring Ø 6,5 cm

for glasses size 0,2 - 0,3 liter, for 10 glasses, ring Ø 6,5 cm

para vasos tamaño 0,2-0,3 l, para 10 vasos, Ø 6,5 cm

pour verres de 0,2 à 0,3 l, pour 10 verres, Ø 6,5 cm

	cm	↑ cm
00632	40 x 16,5	29



Trinkbecher „CRYSTAL“
drinking cups
vasos
gobelets



Kristallglas-Optik, vielseitig einsetzbar, robustes, unzerbrechliches Material, ideal in sensiblen Bereichen wie Pool, Spa, Beach und Wellness einzusetzen, BPA-frei
crystal-glass-look, can be used in versatile ways, a solide and unbreakable material, ideal to be used at pool, spa, beach and wellness areas, bpa-free

aspecto vidrio, se pueden utilizar de muchas maneras diferentes, material sólido e irrompible, ideal para el uso en áreas como piscina, spa, playa y bienestar, libre de BPA
ressemble à un verre de cristal, peuvent être utilisés de différentes façons, matériau robuste et incassable, idéal pour une utilisation dans des zones comme la piscine, le spa, la plage et le bien-être, sans BPA

	Ø cm	↑ cm	ltr.	VE	Farbe / Colour
10500	7	9,5	0,15	48	—
10503	7,5	11,0	0,20	48	—
10501	8	12,5	0,30	48	—
10504	8,5	14,0	0,40	48	—
10502	9	15,5	0,50	48	—

	Ø cm	↑ cm	ltr.	VE	Farbe / Colour
10513	7	9,5	0,15	48	
10516	7,5	11,0	0,20	48	
10514	8	12,5	0,30	48	
10517	8,5	14,0	0,40	48	
10515	9	15,5	0,50	48	



UNZERBRECHLICH
UNBREAKABLE

Made in Germany

Auch die inneren Werte können sich sehen lassen. Der Trinkbecher „CRYSTAL“ wird ressourcenschonend ausschließlich in Deutschland produziert. Das Material ist zu 100% recycelbar.





	Ø cm	↑ cm	ltr.	VE	Farbe / Colour
10510	7	9,5	0,15	48	
10511	8	12,5	0,30	48	
10512 <small>NEW</small>	9	15,5	0,50	48	
	Ø cm	↑ cm	ltr.	VE	Farbe / Colour
10525	7	9,5	0,15	48	
10526 <small>NEW</small>	8	12,5	0,30	48	
10527	9	15,5	0,50	48	
	Ø cm	↑ cm	ltr.	VE	Farbe / Colour
10528	7	9,5	0,15	48	
10529	8	12,5	0,30	48	
10530	9	15,5	0,50	48	
	Ø cm	↑ cm	ltr.	VE	Farbe / Colour
10531	7	9,5	0,15	48	
10532	8	12,5	0,30	48	
10533	9	15,5	0,50	48	
	Ø cm	↑ cm	ltr.	VE	Farbe / Colour
10534	7	9,5	0,15	48	
10535	8	12,5	0,30	48	
10536	9	15,5	0,50	48	



UNZERBRECHLICH
UNBREAKABLE

0,15 ltr.
10510

0,30 ltr.
10511

0,50 ltr.
10536

0,30 ltr.
10532

0,50 ltr.
10533

Farbe grau
colour light grey





stapelbar
stackable

10509

Trinkglas „BEACH“
drinking glass
vaso
verre













vielseitig einsetzbar, robustes, unzerbrechliches Material, BPA-frei
can be used in versatile ways, a solide and unbreakable material, bpa-free
se pueden utilizar de muchas maneras diferentes, material sólido e irrompible, libre de BPA
peuvent être utilisés de différentes façons, matériau robuste et incassable, sans BPA

	Ø cm	↑ cm	ltr.	VE	Farbe / Colour
10509 <small>NEW</small>	8,5	13,5	0,30	48	
10505	8,5	13,5	0,30	48	–



Trinkbecher „LINEA“
drinking cups
vasos
gobelets



Die elegant facettierten Bechergläser LINEA lassen sich vielseitig im Bar-, Club-, Pool-, und Buffetbereich verwenden. Sowohl die transparenten als auch die farbigen Modelle setzen in jedem Ambiente edle Akzente. Dank ihrer perfekten Stapelbarkeit werden sie platzsparend aufbewahrt und transportiert.

The elegantly faceted tumbler glasses LINEA can be used in a variety of ways in the bar, club, pool and buffet areas. Both the transparent and coloured models set elegant accents in any ambience. Thanks to their perfect stackability, they are space-saving to store and transport.

Los vasos LINEA, elegantemente facetados, pueden utilizarse de diversas maneras en el bar, el club, la piscina y el buffet. Tanto los modelos transparentes como los de color ponen elegantes acentos en cualquier ambiente. Gracias a su perfecta apilabilidad, ahorran espacio para su almacenamiento y transporte.

Les verres LINEA élégamment facetés peuvent être utilisés de manière polyvalente dans les bars, les clubs, les piscines et les buffets. Les modèles transparents et colorés apportent une touche de noblesse dans chaque ambiance. Grâce à leur parfaite empilabilité, ils se rangent et se transportent avec un minimum d'encombrement.

	Ø cm	↑ cm	ltr.	VE	Farbe / Colour
10560	6,5	8,0	0,15	48	—
10561	8,5	8,0	0,22	48	—
10562	8,5	10,0	0,30	48	—
10563	8,5	12,0	0,40	48	—
10564	8,5	15,0	0,50	48	—
10565	6,5	8,0	0,15	48	french grey
10566	8,5	8,0	0,22	48	french grey
10567	8,5	10,0	0,30	48	french grey
10568	8,5	12,0	0,40	48	french grey
10569	8,5	15,0	0,50	48	french grey
10570	6,5	8,0	0,15	48	light green
10571	8,5	8,0	0,22	48	light green
10572	8,5	10,0	0,30	48	light green
10573	8,5	12,0	0,40	48	light green
10574	8,5	15,0	0,50	48	light green
10575	6,5	8,0	0,15	48	light pink
10576	8,5	8,0	0,22	48	light pink
10577	8,5	10,0	0,30	48	light pink
10578	8,5	12,0	0,40	48	light pink
10579	8,5	15,0	0,50	48	light pink



MOSCOW MULE



Flaschenkühler „MOSCOW MULE“

bottle cooler
enfriador de botellas
rafraîchisseur de bouteilles



Edelstahl-Flaschenkühler, Antik-Kupfer-Look
stainless steel cooler, copper antique look
enfriador de acero inoxidable, cobre estilo antiguo
rafraîchisseur en acier inox, cuivre style antique

	Ø cm	↑ cm	ltr.	Farbe / Colour
93330	20	21	5	 copper-antique-hammered



Becher „MOSCOW MULE“, 2er-Set

barrel copper mug, 2 pcs.
taza, set de 2
gobelet, set de 2



Edelstahlbecher, Antik-Kupfer-Look
stainless steel cup, copper antique look
taza de acero inoxidable, cobre estilo antiguo
gobelet en acier inox, cuivre style antique

	Ø cm	↑ cm	ltr.	Farbe / Colour
93367	9	10	0,5	 copper-antique-hammered



Becher „MOSCOW MULE“

barrel mug
taza
gobelet



Edelstahlbecher, Antik-Edelstahl-Look
stainless steel cup, stainless steel antique look
taza de acero inoxidable, acero estilo antiguo
gobelet en acier inox, acier style antique

	Ø cm	↑ cm	ltr.	Farbe / Colour
93346	9	10	0,5	 stainless-antique-hammered



Becher „MOSCOW MULE“

barrel mug
taza
gobelet



Edelstahlbecher, Antik-Edelstahl-Look
stainless steel cup, stainless antique look
taza de acero inoxidable, acero estilo antiguo
gobelet en acier inox, acier style antique

	Ø cm	↑ cm	ltr.	Farbe / Colour	
93345	9	9	0,45		stainless-antique



Becher „MOSCOW MULE“

barrel copper mug
taza
gobelet



Edelstahlbecher, Antik-Kupfer-Look
stainless steel cup, copper antique look
taza de acero inoxidable, cobre estilo antiguo
gobelet en acier inox, cuivre style antique

	Ø cm	↑ cm	ltr.	Farbe / Colour	
93322	9	9	0,45		copper-antique



Becher „MOSCOW MULE“

barrel copper mug
taza
gobelet



Edelstahlbecher, Kupfer-Look, glänzend
stainless steel cup, copper look, highshine
taza de acero inoxidable, cobre, brillante
gobelet en acier inox, cuivre, brillant

	Ø cm	↑ cm	ltr.	Farbe / Colour	
93310	9	9	0,45		copper-look



Becher „MOSCOW MULE“

barrel copper mug
taza
gobelet



Edelstahlbecher, Kupfer-Look, glänzend
stainless steel cup, copper look, highshine
taza de acero inoxidable, cobre, brillante
gobelet en acier inox, cuivre, brillant

	Ø cm	↑ cm	ltr.	Farbe / Colour	
93311	9	10	0,50		copper-hammered



Becher „MOSCOW MULE“

barrel copper mug
taza
gobelet



Edelstahlbecher, Antik-Kupfer-Look
stainless steel cup, copper look
taza de acero inoxidable, cobre estilo antiguo
gobelet en acier inox, cuivre style antique

	Ø cm	↑ cm	ltr.	Farbe / Colour	
93323	9	10	0,50		copper-antique-hammered



Becher „MOSCOW MULE“

barrel mug
taza
gobelet



Edelstahlbecher, Antik-Edelstahl-Look
stainless steel cup, stainless antique look
taza de acero inoxidable, acero estilo antiguo
gobelet en acier inox, acier style antique

	Ø cm	↑ cm	ltr.	Farbe / Colour	
93333	9,5	10	0,50		stainless-antique



Becher „MOSCOW MULE“

barrel copper mug
taza
gobelet



Edelstahlbecher, Antik-Kupfer-Look
stainless steel cup, copper antique look
taza de acero inoxidable, cobre estilo antiguo
gobelet en acier inox, cuivre style antique

	Ø cm	↑ cm	ltr.	Farbe / Colour	
93331	9,5	10	0,50		copper-antique



Becher „MOSCOW MULE“

barrel copper mug
taza
gobelet



Edelstahlbecher, Kupfer-Look, glänzend
stainless steel cup, copper look, glossy
taza de acero inoxidable, cobre, brillante
gobelet en acier inox, cuivre, brillant

	Ø cm	↑ cm	ltr.	Farbe / Colour	
93332	9,5	10	0,50		copper-look



Becher „MINI SHOT“, 4er-Set

barrel mug 4 pcs.
taza, set de 4
gobelet, set de 4



	Ø cm	↑ cm	ltr.	Farbe / Colour	
93342	4,5	4,5	0,05		copper-antique
93343	4,5	4,5	0,05		copper-look
93344	4,5	4,5	0,05		stainless-antique



Becher „COCKTAIL MUG“

barrel
taza
gobelet



	Ø cm	↑ cm	ltr.	Farbe / Colour	
93370	8,5	14	0,5		stainless



Becher „COOL“

barrel mug
taza
gobelet



Edelstahlbecher, Kupfer-Look, glänzend
stainless steel cup, copper look, glossy
taza de acero inoxidable, estilo cobre, brillante
gobelet en acier inox, aspect cuivre, brillant

	Ø cm	↑ cm	ltr.	Farbe / Colour	
93371	7,5	10,5	0,35		copper-look



Becher „COOL“

barrel mug
taza
gobelet



Edelstahlbecher, Gunmetal-Look, glänzend
stainless steel cup, gunmetal look, glossy
taza de acero inoxidable, estilo gunmetal, brillante
gobelet en acier inox, aspect gunmetal, brillant

	Ø cm	↑ cm	ltr.	Farbe / Colour	
93372	7,5	10,5	0,35		gunmetal-look



Becher „COOL“

barrel mug
taza
gobelet



Edelstahlbecher, Antik-Edelstahl-Look
stainless steel cup, stainless antique look
taza de acero inoxidable, acero estilo antiguo
gobelet en acier inox, acier style antique

	Ø cm	↑ cm	ltr.	Farbe / Colour	
93373	7,5	10,5	0,35		stainless-antique



Becher „COOL“

barrel mug
taza
gobelet



Edelstahlbecher, Regenbogen-Look
stainless steel cup, rainbow look
taza de acero inoxidable, estilo arco iris
gobelet en acier inox, look arc-en-ciel

	Ø cm	↑ cm	ltr.	Farbe / Colour	
93374	7,5	10,5	0,35		rainbow-look



Becher „BEER MUG“

barrel mug
taza
gobelet



	Ø cm	↑ cm	ltr.	Farbe / Colour	
93364	8,5	13	0,50		copper-antique
93365	8,5	13	0,50		stainless-antique



Becher „PINEAPPLE“

barrel mug
taza
gobelet



Glasbecher mit Edelstahl Deckel
glass cup with stainless steel lid
taza de cristal con tapa en acero inoxidable
gobelet en verre avec couvercle en acier inox

	Ø cm	↑ cm	ltr.
93375	8,5	17,5	0,35



Becher „PINEAPPLE“

barrel mug
taza
gobelet



Edelstahlbecher, Kupfer-Look
stainless steel cup, copper look
taza de acero inoxidable, cobre
gobelet en acier inox, cuivre

	Ø cm	↑ cm	ltr.	Farbe / Colour
93334	9	19	0,5	copper-look



Becher „PINEAPPLE“

barrel mug
taza
gobelet



Edelstahlbecher, Gold-Look
stainless steel cup, gold look
taza de acero inoxidable, dorada
gobelet en acier inox, doré

	Ø cm	↑ cm	ltr.	Farbe / Colour
93335	9	19	0,5	gold-look



Gläserchiene

glass rack
rack de copas
rack porte-verres





aus 6 mm Draht, Metall verchromt, Wand- und Deckenmontage möglich
6 mm chrome plated wire, can be mounted under a shelf or on the wall
alambre cromado de 6 mm, puede instalarse bajo una estantería o en la pared
fil chromé de 6 mm, à installer sous une étagère ou contre un mur

	cm	↑ cm	for glasses	Farbe / Colour
93398	29,5 x 32	6	12	chrome
93399	29,5 x 32	6	12	black
93400	45,0 x 32	6	20	chrome



Becher „JULEP MUG“
barrel mug
taza
gobelet



	Ø cm	↑ cm	ltr.	Farbe / Colour
93336	8	11,5	0,40	 copper-antique-hammered
93337	8	11,5	0,40	 copper-hammered
93338	8	11,5	0,40	 stainless-antique-hammered



Becher „JULEP MUG“
barrel mug
taza
gobelet



	Ø cm	↑ cm	ltr.	Farbe / Colour
93327	8,5	10	0,35	 copper-antique
93328	8,5	10	0,35	 copper-look
93329	8,5	10	0,35	 stainless



NEW

Mini Feuerzangen-Set's

Zuckerhut / sugar cones



inkl. 50 Stk.
incl. 50 pcs.

6 Stk.
6 pcs.



Mini Feuerzangen-Set I

mini fire punch bowl set
mini set para ponche caliente
mini set pour punch



bestehend aus:

6 Mini Feuerzangen / 50 Mini Zuckerhüte

consisting of:

6 mini fire tongs / 50 mini sugar cones

compuesto por:

6 mini pinzas para el fuego / 50 mini conos de azúcar

composé de:

6 mini-pinces à feu / 50 mini-cônes à sucre

	cm	↑ cm
65070	14,5 x 3,5	1,5

Zuckerhut / sugar cones



inkl. 50 Stk.
incl. 50 pcs.

2 Stk.
2 pcs.



2 Stk.
2 pcs.



Mini Feuerzangen-Set II

mini fire punch bowl set
mini set para ponche caliente
mini set pour punch



bestehend aus:

2 Edelstahlbecher, Kupfer-Look / 2 Mini Feuerzangen / 50 Mini Zuckerhüte

consisting of:

2 stainless steel cups, copper look / 2 mini fire tongs / 50 mini sugar cones

compuesto por:

2 tazas de acero inoxidable, cobre / 2 mini pinzas para el fuego / 50 mini conos de azúcar

composé de:

2 tasses en acier inox, cuivre / 2 mini-pinces à feu / 50 mini-cônes à sucre

	Ø cm	↑ cm	litr.
65071	9	9	0,45

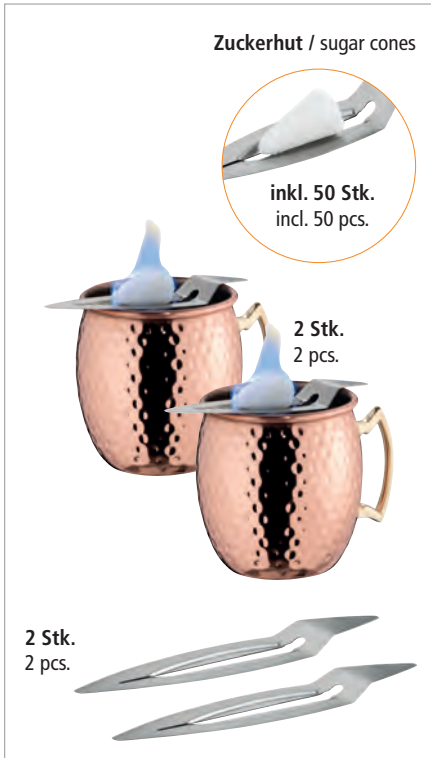

Mini Feuerzangen-Set III
mini fire punch bowl set
mini set para ponche caliente
mini set pour punch



bestehend aus:
2 Edelstahlbecher, Kupfer-Look / 2 Mini Feuerzangen / 50 Mini Zuckerhüte
consisting of:
2 stainless steel cups, copper look / 2 mini fire tongs / 50 mini sugar cones
compuesto por:
2 tazas de acero inoxidable, cobre / 2 mini pinzas para el fuego / 50 mini conos de azúcar
composé de:
2 tasses en acier inox, cuivre / 2 mini-pinces à feu / 50 mini-cônes à sucre

	Ø cm	↑ cm	ltr.
65072	9	10	0,5



Fondue und Feuerzangenbowl-Set „TWO IN ONE“
fondue and fire punch bowl set
set para fondue o ponche caliente
service à fondue et à punch



13-teiliges Set aus Edelstahl bestehend aus:
1 Topf, 1 Rechaud, 1 Spritzschutz, 1 Untersetzer, 1 Schöpfkelle, 1 Feuerzange,
1 Pastenbrenner, 6 Fonduegabeln
13-piece stainless steel set consisting of:
1 pot, 1 rechaud, 1 splash guard, 1 coaster, 1 ladle, 1 fire tongs,
1 paste burner, 6 fondue forks

set de 13 piezas de acero inoxidable compuesto por:
1 olla, 1 rechaud, 1 protector contra salpicaduras, 1 trébede, 1 cazo,
1 pinza para el fuego, 1 quemador de pasta, 6 tenedores de fondue
set de 13 pièces en acier inox comprenant:
1 marmite, 1 rechaud, 1 pare-éclaboussures, 1 dessous de plat, 1 louche, 1 pince à feu,
1 brûleur à pâte, 6 fourchettes à fondue

	Ø cm	↑ cm	ltr.
65060	22	23	2,2



Shaker „CLASSIC“

shaker
coctelera
shaker



Edelstahlbecher, hochglanzpoliert
stainless steel cup, mirror polished finish
taza de acero, acabado pulido brillante
gobelet en acier, brillant

	Ø cm	↑ cm	ltr.
36010	8,5	20	0,5
36011	9,0	23	0,7



Shaker „CLASSIC“

shaker
coctelera
shaker



Edelstahlbecher, Kupfer-Look, glänzend
stainless steel cup, copper look, highshine
taza de acero inoxidable, cobre, brillante
gobelet en acier inox, cuivre, brillant

	Ø cm	↑ cm	ltr.	Farbe / Colour
93211	8,5	20	0,5	 copper-look
93212	9,0	23	0,7	 copper-look



Shaker „CLASSIC“

shaker
coctelera
shaker



Edelstahlbecher
stainless steel cup
taza de acero inoxidable
gobelet en acier inox

	Ø cm	↑ cm	ltr.	Farbe / Colour
93366	9,0	23	0,7	 stainless-antique
93326	9,0	23	0,7	 copper-antique



Parisian Shaker

shaker
coctelera
shaker



Edelstahlbecher, mattiert
stainless steel cup, satin polished finish
taza de acero, acabado efecto satinado
gobelet en acier, fini mat effet satin

	Ø cm	↑ cm	ltr.
93179	9,5	24	0,7



Boston Shaker

boston shaker
coctelera boston
shaker boston



2-teilig: Becher, 700 ml + Glas, 400 ml

2 pcs. set: beaker, 700 ml + glass, 400 ml

set de 2 piezas: vaso coctelero, 700 ml+ vaso vidrio 400 ml

2 pièces: bol mélangeur, 700 ml + bol en verre 400 ml

	Ø cm	↑ cm	ltr.	Farbe / Colour	
93140	9	30	0,70 / 0,40		stainless-steel
93350	9	30	0,70 / 0,40		stainless-antique

	Ø cm	↑ cm	ltr.	Farbe / Colour	
93325	9	30	0,70 / 0,40		copper-antique
93201	9	30	0,70 / 0,40		copper-look

Ersatzglas / spare glass / vaso de recambio / verre de rechange

	Ø cm	↑ cm	ltr.
93138	8,5	14,5	0,4

Boston Shaker

boston shaker
coctelera boston
shaker boston



2-teilig: Becher, 700 ml, gummiert, rutschfest + Glas, 400 ml

2 pcs. set: beaker, 700 ml, rubberized, anti-slip + glass, 400 ml

conjunto de 2 piezas: vaso coctelero con goma exterior 700 ml + vaso de vidrio 400 ml

2 pièces: bol mélangeur inox extérieur plastifié couleur 700 ml + bol en verre 400 ml

	Ø cm	↑ cm	ltr.	Farbe / Colour
93139	9	30	0,7	

Ersatzglas / spare glass / vaso de recambio / verre de rechange

	Ø cm	↑ cm	ltr.
93138	8,5	14,5	0,4



Barmaß
jigger
medidor jigger
measure double jigger



	Ø cm	↑ cm	cl.	Farbe / Colour	
93351	4,5	9	2 / 4		stainless-steel-polished



Barmaß
jigger
medidor jigger
measure double jigger



	Ø cm	↑ cm	cl.	Farbe / Colour	
93354	4,5	9	2 / 4		stainless-antique



Barmaß
jigger
medidor jigger
measure double jigger



	Ø cm	↑ cm	cl.	Farbe / Colour	
93353	4,5	9	2 / 4		copper-look



Barmaß
jigger
medidor jigger
measure double jigger



	Ø cm	↑ cm	cl.	Farbe / Colour	
93352	4,5	9	2 / 4		copper-antique



Barmaß
jigger
medidor
measure double jigger

EDELSTAHL
STAINLESS
INOX 

	∅ cm	↑ cm	cl.	Farbe / Colour	
93164	4,5	9	1,5 / 2,5 / 3,5 / 5		stainless-steel-polished



Barmaß
jigger
medidor jigger
measure double jigger

EDELSTAHL
STAINLESS
INOX 

	∅ cm	↑ cm	cl.	Farbe / Colour	
93355	4,0	11	1,5 / 2,5 / 3,5 / 5		stainless-antique



Barmaß
jigger
medidor jigger
measure double jigger

EDELSTAHL
STAINLESS
INOX 

	∅ cm	↑ cm	cl.	Farbe / Colour	
93324	4	11	1,5 / 2,5 / 3,5 / 5		copper-antique



Barmaß
jigger
medidor jigger
measure double jigger

EDELSTAHL
STAINLESS
INOX 

	∅ cm	↑ cm	cl.	Farbe / Colour	
93165	4	11	1,5 / 2,5 / 3,5 / 5		copper-look



Barmaß
jigger
medidor jigger
measure double jigger



hochglanzpoliert, schnelles und genaues Abmessen von Spirituosen
mirror polished finish, quick and exact measuring of spirits
pulido brillante, medida rápida y exacta de licores
poli miroir, mesure exact et rapide des spiritueux

	Ø cm	↑ cm	cl
93116	6 / 5	6	2 / 4



Barmaß
jigger
medidor jigger
measure double jigger



	Ø cm	↑ cm	cl
93120	4,5 / 3,5	7,0	2 / 4



Barmaß
jigger
medidor jigger
measure double jigger



	Ø cm	↑ cm	cl
93121	4,0 / 3,5	8,5	2 / 4
93112	4,5 / 4,0	8,5	2,5 / 5



Barmaß
jigger
medidor jigger
measure double jigger



hochglanzpoliert, schnelles und genaues Abmessen von Spirituosen
mirror polished finish, quick and exact measuring of spirits
pulido brillante, medida rápida y exacta de licores
poli miroir, mesure exact et rapide des spiritueux

	Ø cm	↑ cm	cl.
93357	3,5	7,5	3 / 5



Barmaß
jigger
medidor jigger
measure double jigger



hochglanzpoliert, schnelles und genaues Abmessen von Spirituosen
mirror polished finish, quick and exact measuring of spirits
pulido brillante, medida rápida y exacta de licores
poli miroir, mesure exact et rapide des spiritueux

	Ø cm	↑ cm	cl.
93356	5	9	1 / 1,5 / 2 / 3 / 4 / 6

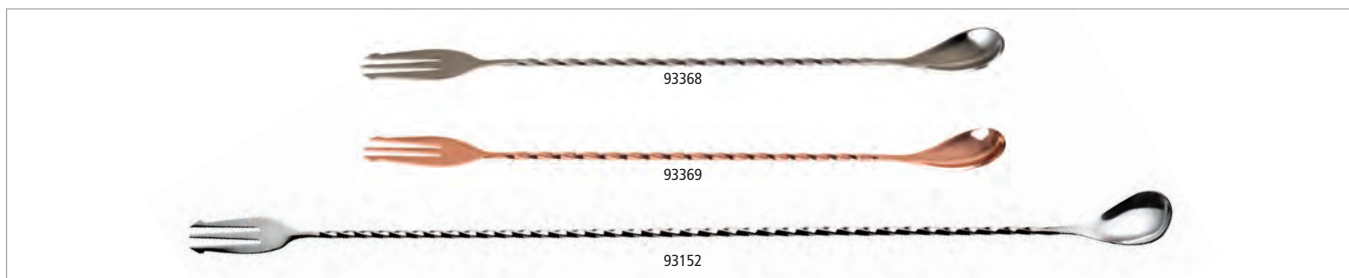

Barlöffel / -gabel

bar spoon
cucharilla de cóctel trident
cuillère de bar trident



	→ cm	Farbe / Colour	
93368	30		stainless steel
93369	30		copper-look
93152	50		stainless steel

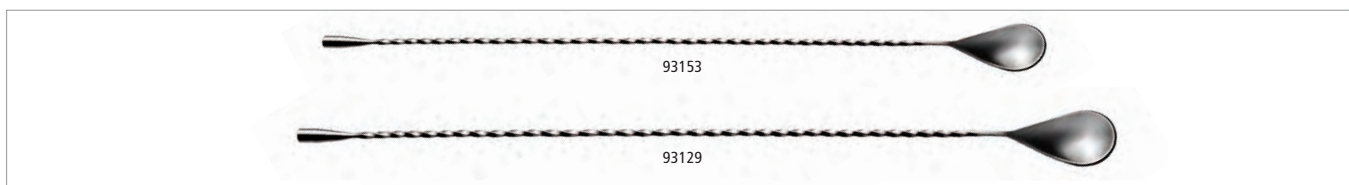

Barlöffel

bar spoon
cucharilla de cóctel
cuillère à cocktail



	→ cm
93153	40
93129	44

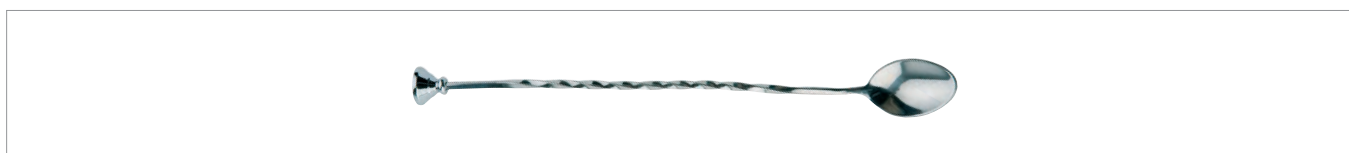

Barlöffel

bar spoon
cucharilla de cóctel
cuillère à cocktail



	→ cm
93134	27

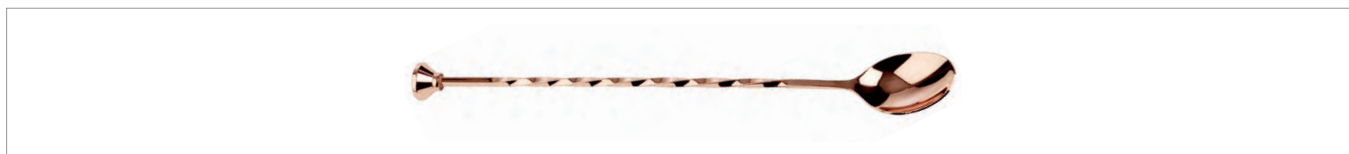

Barlöffel

bar spoon
cucharilla de cóctel
cuillère à cocktail



	→ cm	Farbe / Colour	
93034	27		copper-look

hot price



Barsieb
bar strainer
colador de cóctel
tamis cocktail



hochglanzpoliert, Spiralfeder hält Eiswürfel beim Abseihen zurück, Feder kann zur Reinigung entnommen werden, passend für alle Gläser und Shaker
mirror polished finish, coil spring keeps ice cubes in shaker, spring can be taken off for cleaning, suitable for all glasses and shakers
con muelle para mantener los cubitos en la coctelera, el muelle se desmonta para limpiar, se adapta a todos los tipos de vasos y cocteleras
brillant, avec ressort pour garder les glaçons dans le shaker, ressort démontable pour lavage, s'adapte à tous types de verres mélangeurs et shakers

	Ø cm	Griff / handle cm	→ Ø cm
93300	8	6	mit Auflage-Örchen 12



Einhandgebrauch
handed use

Julep Barsieb „PRO“
julep strainer
colador de cóctel
tamis cocktail



hochglanzpoliert
mirror polished finish
acabado pulido brillante
fini poli brillant

	Ø cm	Griff / handle cm
93313	7,5	9



Barsieb
bar strainer
colador de cóctel
tamis cocktail



Spiralfeder hält Eiswürfel beim Abseihen zurück, Feder kann zur Reinigung entnommen werden, passend für alle Gläser und Shaker

coil spring keeps ice cubes in shaker, spring can be taken off for cleaning, suitable for all glasses and shakers
con muelle para mantener los cubitos en la coctelera, el muelle se desmonta para limpiar, se adapta a todos los tipos de vasos y cocteleras
avec ressort pour garder les glaçons dans le shaker, ressort démontable pour lavage, s'adapte à tous types de verres mélangeurs et shakers

	Ø cm	Griff / handle cm	Farbe / Colour
93347	9	9	copper-antique
93348	9	9	copper-look
93349	9	9	stainless-antique
93312	9	9	stainless



Einhandgebrauch
single-handed use



Stößel
muddler
mortero
pilon muddler



zum Auspressen von Früchten und Zerstoßen von Würfelzucker

to press fruits or pound lump sugar
para exprimir frutas y machacar azucarillos
pour presser les fruits ou le sucre en morceaux

	∅ cm	→ cm
93188	4	28



Stößel
muddler
mortero
pilon muddler



mit griffigem Ende, zum Auspressen von Früchten und Zerstoßen von Würfelzucker

with handy end, to press fruits or pound lump sugar
acabado relieve para prensar frutas o azucar
avec relief grillagé pour presser les fruits ou le sucre en morceaux

	∅ cm	→ cm	Farbe / Colour
93180	2,5	21	



Stößel
muddler
mortero
pilon muddler



mit griffigem Ende, zum Auspressen von Früchten und Zerstoßen von Würfelzucker

with handy end, to press fruits or pound lump sugar
con un acabado en relieve para exprimir frutas y machacar azucarillos
avec relief grillagé pour presser les fruits ou le sucre en morceaux

	∅ cm	→ cm	Farbe / Colour	€
93362	3,5	20,5	antique-copper-look	
93358	3,5	20,5	stainless steel	
93360	3,5	20,5	copper-look	
93361	3,5	20,5	stainless-antique look	



Stößel
muddler
mortero
pilon muddler



grober Stößel, zum Auspressen von Früchten und Zerstoßen von Würfelzucker

coarse notched, to press fruits or pound lump sugar
mortero grueso con muescas para exprimir frutas y machacar azucarillos
muddler grand format avec bout relief étoile pour presser les fruits ou le sucre en morceaux

	∅ cm	→ cm	Farbe / Colour
93181	2,5	21	
93182	4	24	



Barsieb
bar strainer
colador de cóctel
tamis cocktail



	Ø cm	→ cm
93318	8,5	11,5



Schneidebrett „BAR“
cutting board
table de corte
planche à découper



HDPE, mit Safrinne, mit Antirutsch-Füßchen
HDPE, with juice groove and non-slip feet
HDPE, con ranura para líquidos y pies antideslizantes
HDPE, avec rigole et pieds antidérapants

	cm	↑ cm
93306	30 x 20	2
93307	50 x 30	2



Zitruspresse
citrus squeezer
exprimidor cítricos
presse-citron



hochglanzpoliert, 2-teilig
mirror polished finish, 2 pcs.
pulido brillante, 2 piezas
brillant, 2 pièces

	Ø cm	↑ cm	ltr.
71431	12 / 17	10,5	0,35



Cocktailmesser „ORANGE“
bar knife
cuchillo para cóctel
couteau cocktail



mit 2 Zinken zum Aufspießen von Zitrusseiben
with 2 prongs to pick up slices of lemon
con 2 dientes para pinchar las rodajas de limón, etc.
avec 2 dents pour les rondelles de citron et autres décorations

	→ cm
88846	21



Dekoriermesser „ORANGE“
decorating knife „canalé“
cuchillo acanalador
couteau cannelé



gezahnte Klinge aus geschärftem Edelstahl
serrated sharpened blade, stainless steel
hoja de sierra afilada, acero inoxidable
lame inox microdentée

	→ cm
88843	19



2 Pressringe für Zitrone und Limette

Limetten- / Zitronenpresse
lime- / lemonpress
exprimidor de limón / lima
presse citron



	cm	↑ cm
93214	21 x 7	5



Limettenpresse
lime press
prensa de limón
presse citron



	cm	↑ cm
93189	21 x 7	5



1,3 ltr.

Eiseimer-Set mit Eiszange
ice bucket set with tong
cubitera clásica con pinza
seau à glaçons classique avec pince



mit Abtropfgitter, isolierter Kunststoffeinsatz, Zange lässt sich im Deckel verstauen,
für max. 50 Eismwürfel, hält die Eismwürfel bis zu 5 Stunden in ihrer Form

with drainer, insulated plastic insert, tongs can be stored in the lid,
for max. 50 ice cubes, keeps the ice cubes in shape for up to 5 hours

con escurridor, inserto de plástico aislado, la pinza se puede guardar en la tapa, para un
máximo de 50 cubitos de hielo, mantiene los cubitos de hielo en forma hasta 5 horas

avec égouttoir, insert en plastique isolé, la pince peut être rangée dans le couvercle, pour
max. 50 glaçons, maintient les glaçons dans leur forme jusqu'à 5 heures

	Ø cm	↑ cm	ltr.
36015	14	22	1,3



1,0 ltr.

Eiseimer-Set mit Eiszange
ice bucket set with tong
cubitera clásica con pinza
seau à glaçons classique avec pince



für max. 45 Eismwürfel, hält die Eismwürfel bis zu 5 Stunden in ihrer Form

max. 45 ice cubes, keeps the ice cubes in shape for up to 5 hours

para un máximo de 45 cubitos de hielo, mantiene los cubitos de hielo en forma hasta 5 horas

pour max. 45 glaçons, maintient les glaçons dans leur forme jusqu'à 5 heures

	Ø cm	↑ cm	ltr.
36013	12	14	1



Eisbox

icebox
cubitera
seau à glaçons



herausnehmbarer Innenbehälter dient als Tropfeinsatz,
hält bis zu 5 Stunden die Eiswürfel in ihrer Form

removable inner container serves as drainer,
keeps the ice cubes in shape for up to 5 hours

contenedor interior extraíble sirve como inserto de goteo,
mantiene los cubitos de hielo en forma hasta 5 horas

réceptier intérieur amovible sert d'égouttoir,
maintient les glaçons dans leur forme jusqu'à 5 heures

	Ø cm	↑ cm	ltr.	
36033	18,5	20	3	max. 150 ice cubes
36037	27	20	6	max. 300 ice cubes



Eisbox

icebox
cubitera
seau à glaçons



herausnehmbarer Innenbehälter dient als Tropfeinsatz, für max. 150 Eiswürfel,
hält bis zu 5 Stunden die Eiswürfel in ihrer Form

removable inner container serves as drainer, for max. 150 ice cubes,
keeps the ice cubes in shape for up to 5 hours

contenedor interior extraíble sirve como inserto de goteo, para un
máximo de 150 cubitos de hielo, mantiene los cubitos de hielo en forma hasta 5 horas

réceptier intérieur amovible sert d'égouttoir, pour max. 150 glaçons,
maintient les glaçons dans leur forme jusqu'à 5 heures

	cm	↑ cm	ltr.	
93200	20 x 20	17	3,4	max. 150 ice cubes



Eisbox

icebox
cubitera
seau à glaçons



herausnehmbarer Innenbehälter dient als Tropfeinsatz, für max. 300 Eiswürfel, hält die
Eiswürfel bis zu 5 Stunden in ihrer Form

removable inner container serves as drainer, for max. 150 ice cubes,
ice bucket keeps the ice cubes in shape for up to 5 hours

contenedor interior extraíble sirve como inserto de goteo, para un máximo de 150 cubitos
de hielo, mantiene los cubitos de hielo en forma hasta 5 horas

réceptier intérieur amovible sert d'égouttoir, pour max. 150 glaçons,
maintient les glaçons dans leur forme jusqu'à 5 heures

	Ø cm	↑ cm	ltr.	
93220	27 x 27	15	5	max. 300 ice cubes



Kühlbox „FROSTY“

bottle cooler
enfriador de botellas
rafraichisseur de bouteilles



mit herausnehmbarem Einsatz für 4 Flaschen

with removable insert for 4 bottles

con inserto extraíble para 4 botellas

avec insert amovible pour 4 bouteilles



Abb. ohne Einsatz
illustration without insert

	cm	↑ cm	ltr.	Ø holes cm
93230	27 x 27	15	7,5	11



Eisschaufel
ice scoop
pala de hielo
pelle à glaçons



	cm	→ cm	ltr.
93192	10 x 6	29	0,7



Eisschaufel
ice scoop
pala de hielo
pelle à glaçons



gelocht, ideal zum Befüllen von schlanken Gläsern
perforated, ideal to fill narrow glasses
perforada, ideal para llenar vasos estrechos
perforée, idéale pour verser les glaçons dans des verres étroits

	Ø cm	→ cm
93191	5	19,5



Glasumrander
glass rimmer
ribeteador de vasos
bordeur à verres „rimmer“



Schwamm für Limettensaft, 2 Fächer für Zucker und Salz
with sponge for lime juice, 2 cases for sugar and salt
con esponja para zumo de lima, 2 compartimentos para azucar y sal
avec éponge et 2 compartiments pour sucre et sel

	cm
93175	20 x 7,5



Eis-Kugel-Former
ice ball former
molde de cubitos de hielo esféricos
moule à glaçons en boules



2 tlg., 3 Kugeln à 100 ml, einfach mit Wasser füllen und gefrieren lassen
3 bowls à 100 ml, simply fill with water and allow to freeze
3 bolas de 100 ml, simplemente llenar con agua y dejar congelar
3 boules à 100 ml, simplement remplir avec de l'eau et mettre à congeler

	cm	↑ cm
12990	23,5 x 8,5	6,5



Eiszerkleinerer
Ice crusher
picadora de hielo
broyeur à glaçons



glasklar, mit Edelstahl-Messer
clear, stainless steel cutters
cuchillas de acero inoxidable
couteaux inox

	cm	↑ cm
36017	12 x 12	24



Pinzettenzange

fine tong / tweezer
pinza de emplatar
pince à dresser



hochglanzpoliert, geriffelte Grifffläche, schwere Qualität
mirror polished finish, ribbed handle, heavy gauge
acabado brillante, mango cómodo ranurado, alta calidad
brillant, manche rainuré antiglisse, qualité extra

→ cm

75820

16



Pinzettenzange

fine tong / tweezer
pinza de emplatar
pince à dresser



hochglanzpoliert, geriffelte Grifffläche, schwere Qualität
mirror polished finish, ribbed handle, heavy gauge
acabado brillante, mango cómodo ranurado, alta calidad
brillant, manche rainuré antiglisse, qualité extra

→ cm

75821

30



Eiszange

ice cube tong
pinza para cubitos de hielo
pince à glaçons



hochglanzpoliert, fugenlos
mirror polished finish, seamless
pulido acabado brillante, de una sola pieza
brillant, d'une seule pièce

cm

→ cm

75805

5 x 2

17,5



Eiszange

ice tong
pinza para cubitos de hielo
pince à glaçons



matt poliert, mit griffigem Ende, ideal für Eiswürfel und Obstscheiben
satin polished finish, with handy end, ideal for ice cubes and fruit slices
pulido satinado, forma ergonómica ideal para cubitos de hielo y láminas de fruta
poli mat satiné, forme ergonomique idéale pour glaçons et fruits tranchés

cm

→ cm

93190

2 x 1,5

20



Reinigungsbürste für Ausgießer

pourer cleaning brush
cepillo de limpieza para picos vertedores
brosse lave-bouchons doseurs



→ cm

93102

16,5



Trinkhalme 11er Set

straws, 11 pcs. set
pajas, set de 11 pz.
pailles, set de 11 pc.



11-teiliges Set: 10 Trinkhalme aus Edelstahl + Reinigungsbürste

11 pcs. set: 10 drinking straws made of stainless steel + cleaning brush
set de 11: 10 pajas de acero inoxidable + cepillo de limpieza
set de 11: 10 pailles en acier inox + brosse de nettoyage

	Ø mm	→ cm	Farbe / Colour	
93391	8	15,0		copper-look
93392	8	15,0		gunmetal-look
93393	8	15,0		rainbow-look
93380	6	21,5		copper-look
93381	6	21,5		gunmetal-look
93382	6	21,5		rainbow-look
93383	8	21,5		copper-look
93384	8	21,5		gunmetal-look
93385	8	21,5		rainbow-look

Ersatzbürste / replacement brush / cepillo de recambio / brosse de rechange

	Ø mm	→ cm
93395	8	15
93386	8	20



Trinkhalme 7er Set

straws, 7 pcs. set
pajas, set de 7 pz.
pailles, set de 7 pc.



	Ø mm	→ cm	pcs.
93394	10	15	7
93390	10	21	7





Barmatte

drip mat
tapete escurridor
tapis de bar

aus weichem Kunststoff, zum Abtropfen von Gläsern etc.
soft plastic, to store and drain glasses
plástico blando para escurrir vasos
plastique souple, pour l'égouttage des verres



	cm	↑ cm	Farbe / Colour	
93166	30 x 15	1	■	ohne Vertiefung
93167	45 x 31	1	■	ohne Vertiefung
93173	52 x 8	1	■	ohne Vertiefung
93168	60 x 8	1	■	mit Vertiefung
93169	60 x 8	1	■	ohne Vertiefung



Abtropfmatte

drip mat
esterilla escurridora
tapis égouttoir

gerollt
rolled
enrollada
roulée



	cm	↑ cm	Farbe / Colour
93314	60 x 300	0,3	■
93315	60 x 300	0,3	■

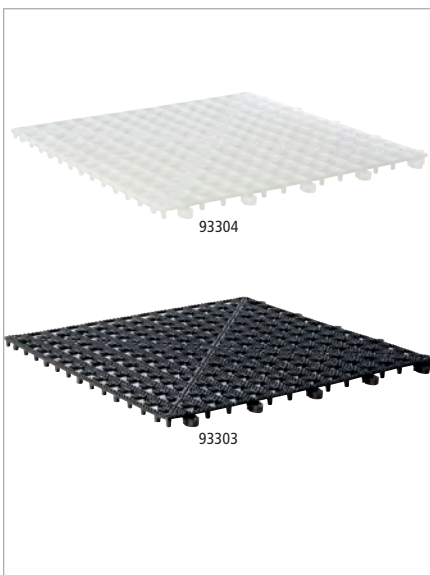

Abtropfmatte

drip mat
esterilla escurridora
tapis égouttoir

erweiterbar durch Klick-Verbindung
expandable
las placas de fijan con clips
avec clips de fixation



	cm	↑ cm	Farbe / Colour
93304	33 x 33	1,5	■
93303	33 x 33	1,5	■





Zutatenbehälter
condiment holder
dispensador de especias
boîte à fruits et ingrédients



500 ml Inhalt pro Fach, 6 Fächer, inkl. Deckel (gefrostet) zur Lagerung
6 chambers á 500 ml, incl. lid for storing
6 compartimentos de 500 ml., incluye tapa para el almacenaje
6 compartiments de 500 ml chacun, avec couvercle pour le stockage

	cm	↑ cm
93171	50 x 16	10



Bar-Caddy
bar caddy
organizador de bar
organisateur „bar caddy“



Ordnungshilfe für Trinkhalme, Rührer, Servietten, Streichhölzer, etc.
to organize straws, stirrers, napkins, matches, etc.
para organizar pajitas, cucharillas, servilletas, cerillas, etc.
pour bien organiser les pailles, agitateurs, cuillers, serviettes et autres accessoires

	cm	↑ cm
93174	24 x 15	11



Getränkspender „OLD FASHIONED“
beverage dispenser
dispensador de bebidas
distributeur de boissons



dicke, stabile Wände, weite Öffnung für große Zutaten, Gestell schwarz
thick, stable walls, a wide opening for large ingredients, black stand
tiene paredes gruesas y estables, amplia abertura para ingredientes grandes, soporte negro
des murs épais et stables, large ouverture pour de grands ingrédients, support noir

	Ø cm	↑ cm	litr.
10409	24,5	50,5	7

inkl. Gestell / incl. stand



Getränkspender „FRUITS“
beverage dispenser
dispensador de bebidas
distributeur de boissons



dicke, stabile Wände, weite Öffnung für große Zutaten, Gestell schwarz
thick, stable walls, a wide opening for large ingredients, black stand
tiene paredes gruesas y estables, amplia abertura para ingredientes grandes, soporte negro
des murs épais et stables, large ouverture pour de grands ingrédients, support noir

	Ø cm	↑ cm	litr.
10415	25	58	10,5

inkl. Gestell / incl. stand



Flaschenkühler „CONFERENCE“

conference bottle cooler
enfriador múltiple
rafraîchisseur



inkl. Kühllakku, Flaschenöffner, Kronkorkenschale,
mit 6 Öffnungen Ø 6,7 cm für 0,25 - 0,5 Liter-Flaschen

incl. bottle cooler, bottle opener, small cap bowl,
with 6 holes Ø 6,7 cm for 0,25 to 0,5 liter bottles

con acumulador de frío, abridor, recuperador de chapas,
6 plazas Ø 6,7 cm, para botellas de 25 a 50 cl

avec accumulateur de froid, décapsuleur, bol récupérateur
de capsules, 6 places Ø 6,7 cm, pour bouteilles de 25 à 50 cl

	Ø cm	↑ cm	Farbe / Colour
00620	23	15	■
00621	23	15	■

Kühllakku / cooler / acumulador de frío / accumulateur de froid

	Ø cm	↑ cm	Farbe / Colour
00616	7,5	11,5	■
00615	7,5	11,5	■

Kronkorkenschale / cap bowl / cuenco para chapas / bol récupérateur de capsules

	Ø cm	↑ cm	Farbe / Colour
00618	6,5	3	■
00619	6,5	3	■

Flaschenöffner / bottle opener / abridor / décapsuleur

	Ø cm	→ cm
00617	1	13,5



Staubkappen, 2er Set

dust & fly cap, 2 pcs.
tapón antipolvo
bouchon anti-poussières et anti-insectes
schützt vor Staub und Insekten
protects for dust and insects
para proteger de la suciedad e insectos
pour protéger de la poussière et des insectes



	Ø cm	↑ cm	pcs.	Farbe / Colour
93161	4	8	2	■

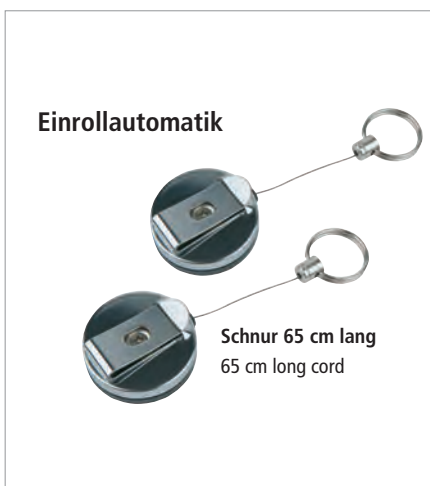

Schlüsselschnur, 2er Set

key cord, 2 pcs.
llavero enrollable
porte-clés avec câble à enroulement
Befestigung mit Klammer am Gürtel, starke Rückzugfeder
to fix at waistbelt, strong pull-back spring
se fija en el cinturón, cable retrocede automáticamente
à fixer à la ceinture, enroulage automatique



	Ø cm	↑ cm
93170	4	2



Dosier- & Vorratsflasche

pouring container
botella „store & pour“
bouteille „store & pour“



4-teilig: Behälter + Flaschenhals + Schraubdeckel + Ausgießer Ø 11 mm mit Luftzufuhr für gezieltes Ausgießen, zum Dosieren und Aufbewahren

4 pcs. set: for storage, mixing and serving drinks, nozzle Ø 11 mm

set de 4 piezas: para almacenar y servir mezclas y bebidas, agujero de Ø 11 mm

se compose de 4 pièces: idéal pour servir et pour conserver les boissons, embout Ø 11 mm

	Ø cm	↑ cm	ltr.	Farbe / Colour
93144	9	33	0,85	
93145	9	33	0,85	
93146	9	33	0,85	
93147	9	33	0,85	
93148	9	33	0,85	



abnehmbarer Boden dient als Deckel

removable bottom serves as a lid



Spritzflasche inklusive Ausgießer

squeeze bottle with nozzle
botella exprimible con dosificador
flacon pulvérisateur avec bec verseur



ideal für Bitter-Liköre, Essig, Öl

perfect for bitter liqueur, vinegar, oil

perfecto para amargo licor, vinagre, aceite

pour amaro liqueur, vinaigre, huile

	cm	↑ cm	ltr.
93308	6 x 5	20	0,2

Ausgießer passend für Spritzflasche / nozzle suitable for squeeze bottle / dosificador apto para botella exprimible / bec verseur approprié pour flacon pulvérisateur

	Ø cm	↑ cm
93309	2,5	5,5



Rührglas mit Lippe

mixing glass with lip
vaso mezclador vertedor con pico
verre mélangeur avec bec verseur



schwere Qualität

heavy quality

alta calidad

qualité renforcée

	Ø cm	↑ cm	ltr.	VE
93101	11,5	19	1	12



1:1 Oberflächenansicht
1:1 structural view

Rührglas mit Lippe

mixing glass with lip
vaso mezclador vertedor con pico
verre mélangeur avec bec verseur



	Ø cm	↑ cm	ltr.
93141	9	16	0,50



Permanent-Ausgießer, 6er Set
 free flow pourer, 6 pcs.
 vertedor continuos set 6 piezas
 set de 6 bouchons verseurs continus

à 2 Stück: blau, rot, gelb
 2 pcs of each colour: blue, red, yellow
 2 piezas de cada color: azul, rojo, amarillo
 2 par couleur: bleu, rouge, jaune



	Ø cm	↑ cm	pcs.
93111	3	7,5	6



Permanent-Ausgießer, 6er Set
 free flow pourer, 6 pcs.
 vertedor continuos set 6 piezas
 set de 6 bouchons verseurs continus



	↑ cm	pcs.
93110	11	6



Ausgießer, 2er Set
 pourers, 2 pcs.
 vertedores set 2 piezas
 set de 2 bouchons verseurs



Portionierer 2 cl, schnelles und genaues Abmessen
 2 cl, quick and exact measuring
 2 cl. medición rápida exacta
 2 cl mesure exacte et rapide

	↑ cm	pcs.
93115	10	2



Permanent-Ausgießer, 6er Set
 free flow pourer, 6 pcs.
 vertedor continuos set 6 piezas
 set de 6 bouchons verseurs continus



	↑ cm	pcs.
93114	8	6



Sekt-Verschluss, 2er Set
 stopper, 2 pcs.
 set de 2 tapones
 set de 2 bouchons



matt poliert, innen Gummi Arabicum
 satin polished finish, inside rubber arabicum, with inscription
 acabado pulido mate, interior goma arábica con inscripción
 poli mat satiné, intérieur gomme arabique

	Ø cm	↑ cm	pcs.
93160	4	5,5	2



Eiswürfel 4 x 4 x 4 cm

Eiswürfelform mit Deckel, 2er Set

ice cube maker with lid, 2 pcs.
molde para cubitos de hielo con tapa, set de 2
moule à glaçons avec couvercle, set de 2



2 Eiswürfelformen für je 9 Stk. Eiswürfel, aus BPA freiem Silikon
2 ice cube moulds for 9 ice cubes each, made of BPA free silicone
2 moldes de cubitos de hielo para 9 cubitos cada uno, fabricados en silicona sin BPA
2 moules à glaçons pour 9 glaçons chacun, fabriqué en silicone sans BPA

	cm	↑ cm	Eiswürfel
36102	15,5 x 15,5	5,5	4 x 4 x 4



Die Eiswürfel lassen sich leicht auslösen
the ice cubes are easy to release



Eiswürfel 4 x 2,5 x 3 cm

Eiswürfelform mit Deckel, 2er Set

ice cube maker with lid, 2 pcs.
molde para cubitos de hielo con tapa, set de 2
moule à glaçons avec couvercle, set de 2



2 Eiswürfelformen für je 21 Stk. Eiswürfel
2 ice cube moulds for 21 ice cubes each
2 moldes de cubitos de hielo para 21 cubitos cada uno
2 moules à glaçons pour 21 glaçons chacun

	cm	↑ cm	Eiswürfel
36103	25 x 15	4	4 x 2,5 x 3





Kellnermesser „PROFI“

waiter's corkscrew
sacacorchos de camarero
tire-bouchons



leichtgängige Teflon-Spirale, mehrstufige Klapphebelfunktion, am Fuß angebrachtes Messer
easy moving teflon coil, 2-stage opening system, knife at the bottom end
mecha de teflón, sistema de apertura en 2 golpes, con cuchillo en la parte superior
mèche téflon, ouverture en 2 étapes, couteau dans la partie supérieure

→ cm

93302 11,5



Kellnermesser

waiter's corkscrew
sacacorchos de camarero
tire-bouchons



leichtgängige Teflon-Spirale, mehrstufige Klapphebelfunktion, am Kopf angebrachtes Messer
easy moving teflon coil, 2-stage opening system, knife at the top end
mecha de teflón, sistema de apertura en 2 golpes, con cuchilla en la parte superior
mèche téflon, ouverture en 2 étapes, couteau dans la partie supérieure

→ cm

93301 12



Kellner-Flaschenöffner

waiter's barblade
abridor camarero
décapsuleur



matt poliert / satin polished finish / pulido acabado mate / poli mat

cm → cm

93122 4 18
00617 Ø 1 13,5



mit Gummierung

Kellner-Flaschenöffner

waiter's barblade
abridor camarero
décapsuleur



mit Gummierung
with rubber coating
con revestimiento de goma
avec revêtement en caoutchouc

cm

93125 11 x 4



Kronkorkenöffner

bottle cap opener
abridor de chapas de pared
décapsuleur mural



für die Wandmontage, aus massivem Metall
for wall fastening, massive metal
para fijación en la pared, metal macizo
massif, à fixer au mur

cm ↑ cm

93124 7 x 8 3



Allzweckgießer

pourer
bote vertedor universal
pot verseur universel



für Honig, Kaffeesahne, etc., Schraubdeckel aus Edelstahl

for honey, cream, etc., cover stainless steel

para miel, crema, etc., tapa inoxidable

pour le miel, le lait, la crème, etc., couvercle inox

	Ø cm	↑ cm	ltr.
00765	8,5	13,5	0,3

Ersatzglasbehälter / spare glas-container / contenedor de repuesto / récipient verre de rechange

00768



Zuckerdosierer

sugar dispenser
azucarero
sucrier



Schraubdeckel aus Edelstahl

cover stainless steel

tapa inoxidable

couvercle inox

	Ø cm	↑ cm	ltr.
00766	8,5	15	0,3

Ersatzglasbehälter / spare glas-container / contenedor de repuesto / récipient verre de rechange

00768



Zuckerdosierer

sugar dispenser
azucarero
sucrier



Schraubdeckel aus Edelstahl, mit Dosierrohr

cover stainless steel with dosingtube

tapa inoxidable y tubo dosificador

couvercle inox et tube doseur

	Ø cm	↑ cm	ltr.
40490	8,5	12	0,15
40494	8,0	15	0,25

Ersatzglasbehälter / spare glas-container / contenedor de repuesto / récipient verre de rechange

fits to

40498	40490
40499	40494



200 ml

Zuckerdosierer

sugar dispenser
azucarero
sucrier



Schraubdeckel aus Edelstahl, mit Dosierrohr
cover stainless steel, with dosing tube
tapa inoxidable y tubo, con cierre dosificador
couvrecler inox et tube doseur

	Ø cm	↑ cm	ltr.
40509	6	14,5	0,2



250 ml

Allzweckgießer

pourer
dosificador
doseur



Schraubdeckel aus Edelstahl und Kunststoff, mit Dosierklappe
cover stainless steel and plastic, with dosing flap
acero inoxidable y tapa plástico, con cierre dosificador
couvrecler en inox et plastique, avec couvercle doseure

	Ø cm	↑ cm	ltr.
40488	8	12,5	0,25



250 ml

Zuckerdosierer

sugar dispenser
azucarero
sucrier



Schraubdeckel aus Edelstahl, mit Dosierrohr
cover stainless steel, with dosing tube
tapa inoxidable y tubo, con cierre dosificador
couvrecler inox et tube doseur

	Ø cm	↑ cm	ltr.
40486	8	15	0,25



320 ml

Zuckerdosierer

sugar dispenser
azucarero
sucrier



Schraubdeckel aus Edelstahl, mit Dosier-Rohr
cover stainless steel, with dosing tube
tapa inoxidable y tubo dosificador
couvrecler inoxydable et tube doseur

	Ø cm	↑ cm	ltr.
40506	7,5	17,0	0,32



320 ml

Zuckerdosierer

sugar dispenser
azucarero
sucrier



Schraubdeckel mit Klappe aus Edelstahl, mit Dosierklappe
cover stainless steel, with dosing flap
tapa acero inoxidable, con cierre dosificador
couvrecler inox, avec couvercle doseure

	Ø cm	↑ cm	ltr.
40487	7,5	13,5	0,32



Zuckerdosierer „OLD FASHIONED“

sugar dispenser
azucarero
sucrier



Schraubdeckel mit Klappe aus Edelstahl, mit Dosierklappe
cover stainless steel, with dosing flap
tapa acero inoxidable, con cierre dosificador
couvercle inox, avec couvercle doseur

	Ø cm	↑ cm	ltr.
40510	7,5	14	0,35



Zuckerdosierer

sugar dispenser
azucarero
sucrier



mit Schraubverschluss, Dosier-Rohr Ø 15 mm
cover and dosingtube Ø 15 mm
con tapa y tubo dosificador Ø 15 mm
couvercle avec tube doseur Ø 15 mm

	Ø cm	↑ cm	ltr.
40508	6,5	14,5	0,20



Zuckerspender / Milchkännchen

sugar pourer / milk jug
dispensador de azúcar
sucrier doseur



matt poliert
satin polished finish
pulido efecto satinado
intérieur et extérieur poli mat

	Ø cm	↑ cm	ltr.
10316	5	15	0,17



Milch-/Universalkanne „ANTIHAFT“

non stick jug
jarra antiadherente
pichet antiadhésif



PTFE-antihafbeschichtet, perfekt für die Herstellung von Milchschaum
PTFE coated, for baristas frothing hot milk
revestimiento PTFE, ideal para espume de leche
revêtement PTFE, idéal pour faire mousser le lait

	Ø cm	↑ cm	ltr.
10334	8,0	10,0	0,35
10335	9,0	11,5	0,60
10336	10,5	13,0	0,80



10328

Milch- / Universalkanne

milk / water jug
jarra leche / agua
pichet à eau / lait



außen hochglanzpoliert, innen matt poliert
outside mirror polished finish, inside satin polished finish
exterior brillante, interior satinado
extérieur brillant, intérieur mat satiné

	Ø cm	↑ cm	ltr.
10328	8,0	10,0	0,35
10329	9,0	11,5	0,6
10330	10,5	13,0	0,8
10331	12,0	16,5	1,3
10332	13,5	18,0	2,0



10323

Kaffeekanne

coffee pot
cafetera
pichet à café



hochglanzpoliert, mit Klappdeckel
mirror polished finish, with hinged cover
acabado brillante, tapa con bisagra
poli brillant, couvercle à charnière

	Ø cm	↑ cm	ltr.
10323	8,0	11,5	0,35
10322	9,0	14,0	0,6
10325	10,5	15,5	0,9
10326	12,0	18,5	1,5
10327	13,5	20,0	2,0



0,3 ltr.

10990

ohne Teesieb / without tea strainer

mit abnehmbarem Deckel
with removable lid

0,8 ltr.

10992

inkl. Teesieb / incl. tea strainer

Teekanne „ASIA“

teapot
tetera
théière



aus Gusseisen, innen emailliert, hält den Tee lange warm, kein nachbittern, ideal für zwei Tassen
made of cast iron, keeps the tea warm for a long time, no bitterness, ideal for two cups
hecho de hierro fundido, mantiene el té caliente durante mucho tiempo, sin amargar, ideal para dos tazas
en fonte, maintient le thé chaud pendant longtemps, pas d'amertume, idéal pour deux tasses

	cm	↑ cm	ltr.	Farbe / Colour
10990	12,5 x 11	12,5	0,3	■

	cm	↑ cm	ltr.	Farbe / Colour
10991	19,5 x 18	15	0,8	■
10992	19,5 x 18	15	0,8	■



Milchkännchen / Sahnegießer

milk / cream jug
jarra de leche/ crema
pichet à eau ou lait



	Ø cm	↑ cm	litr.
10318	4	4	0,05
10319	5	5	0,09
10320	6	6	0,15



Milchkännchen, 4er Set

milk/cream jugs, 4 pcs.
pack de 4 jarritas para leche o crema
pack de 4 crémiers



hochglanzpoliert, für Kaffeesahne, mit Griff, Inhalt à 25 ml

mirror polished finish, for coffee-cream, with handle, capacity à 25 ml

pulido brillante, para crema de café, con asa, capacidad 25 ml

brillant, avec anse, 25 ml

	Ø cm	↑ cm	pcs.	litr.
10321	3,5	3,5	4	0,025

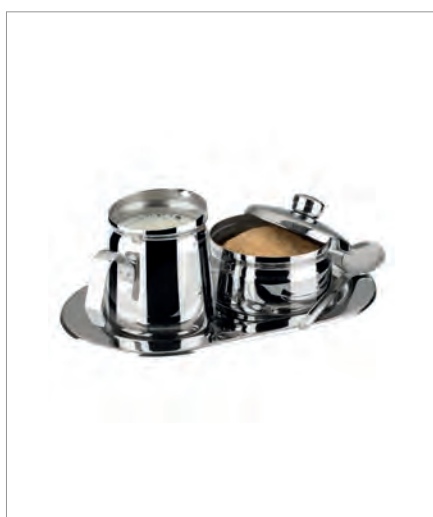

Milch- und Zucker-Set

milk and sugar set
set de leche y azúcar
set sucrier et crémier



Set bestehend aus: Tablett 21 x 14 cm, H: 1,5 cm; Zuckerdose Ø 8cm, H: 7 cm; Milchkännchen Ø 6 cm, H: 8 cm, 0,2 Liter, Löffel

set consisting of: tray 21 x 14 cm, h: 1,5 cm; sugar bowl Ø 8cm, h: 7 cm; milk jug Ø 6 cm, h: 8 cm, 0,2 ltr., spoon

set compuesto por: bandeja 21 x 14 cm, a: 1,5 cm; azucarero Ø 8cm, a: 7 cm; jarra de leche Ø 6 cm, a: 8 cm, 0,2 L., cuchara

ensemble composé de: plateau 21 x 14 cm, h: 1,5 cm; sucrier Ø 8cm, h: 7 cm; crémier Ø 6 cm, h: 8 cm, 0,2 l, cuillère

	cm	↑ cm
00638	21 x 14	7



Zuckertüten-Box

sugar pocket holder
azucarero para bolsitas
porte-sachetsw de sucre



matt poliert, für ca. 15 Zuckertüten

satin polished finish, for ca. 15 sugar packets

acabado pulido efecto satinado, capacidad 15 sobrecillos

poli mat, pour 15 sachets

	cm	↑ cm
11579	9 x 7,5	5



Zuckerkugel

sugar pot
azucarero
sucrier



hochglanzpoliert, mit Rolldecke
mirror polished finish, rolltop cover
pulido acabado brillante, tapa abatible
brillant, couvercle abattant

	∅ cm	↑ cm
00033	13,5	15



Teebrühsieb

snap mesh tea ball
infusor de té, pinza con malla
boule à thé avec pince



matt poliert, mit feinem Sieb, aufklappbar
satin polished finish, with fine mesh, hinged
acabado pulido efecto satinado, con malla fina, con bisagra
inox mat, maille fine, avec charnière

	∅ cm	→ cm
74750	4,5	15,5



Zitronenschnitzelpresse

lemon slice squeezer
pinza exprimelimon
pince presse citron



hochglanzpoliert, zum Auspressen von Zitronenscheiben
mirror polished finish, to press lemon slices
pulido brillante, para rodajas de limón
brillant, pour citrons en rondelle

	cm
71430	8 x 7



Schale, 2-geteilt

bowl, 2-section
cuenco, 2 secciones
bol 2 compartiments



	cm	↑ cm
83538	17,5 x 7,5	4,5



Flambierbrenner

chefs blow torch
soplete de cocina para flambear
chalumeau de cuisine



mit handelsüblichem Feuerzeuggas auffüllbar, Flamme einstellbar
bis ca. 1300° C, Brenndauer von min. 60 Minuten

to be filled with commercial lighter gas, flame adjustable up to
approx. 1300° C, burning time of at least 60 minutes

rellenable con gas de mechero comercial, llama ajustable
hasta 1300 ° C, tiempo de combustión de al menos 60 minutos

rempli avec gaz pour briquet commercial, flamme réglable
jusqu'à 1300 ° C, temps de combustion d'au moins 60 minutes

	∅ cm	↑ cm
77315	4,5	16,5



Tablett „VINTAGE“

tray
bandeja
plateau



Antik-Edelstahl-Look
stainless steel antique look
acero estilo antiguo
acier style antique

	cm	↑ cm
30130	26,0 x 13,5	1,5
30131	34,0 x 18,0	1,5
30132	38,0 x 26,5	1,5
30133	25,5 x 16,0	3,0



passende Schälchen / fitting bowls / cuencos adecuados / bols appropriés



	Ø cm	↑ cm	ltr.
40655	7,5	5,5	0,17
40656	7,5	10	0,35



Servierbeispiel
presentation example



Servierkelle „BOB“

serving trowel
paleta para servir
truelle de service



Edelstahl Servierkelle mit schwarzem Holzgriff
stainless steel serving trowel with black wooden handl
paleta para servir de acero inoxidable con mango de madera negra
truelle de service en acier inox avec manche en bois noir

	cm	↑ cm	Griff / handle cm	Farbe / Colour
40680	23,5 x 15,5	12,5	13,5	stainless steel
40681	23,5 x 15,5	12,5	13,5	■



Tablett

tray
bandeja
plateau



Tablett aus Edelstahl, hochglanzpoliert, stabiler Rand eingerollt
stainless steel tray, mirror polished finish, stable edge rolled in
bandeja de acero inoxidable, pulido efecto espejo, borde estable enrollado
plateau en acier inoxydable, effet brillant, bord stable enroulé

	cm	↑ cm
30148	Ø 27	1,5
30149	30 x 15,5	1,5



Serviertablett „KAFFEEHAUS“

tray
bandeja
plateau



Innenfläche ziseliert, Rand eingerollt / rolled edge / borde redondeado, superficie decor
relieve / bord rond, surface entièrement ciselée

	cm	VE
30114	30 x 22	48



Serviertablett „KAFFEEHAUS“

tray
bandeja
plateau



	cm	↑ cm	Farbe / Colour
84251	26,0 x 20,0	1,5	■
84253	28,5 x 21,5	1,5	■



Serviertablett „KAFFEEHAUS“

tray
bandeja
plateau



matt poliert, Rand eingerollt
satin polished finish, rolled edge
acabado pulido efecto satinado, borde redondeado
effet satin, bord rond

	cm	↑ cm
30118	21,5 x 13	1,5



Serviertablett „KAFFEEHAUS“

tray
bandeja
plateau



matt poliert, Rand eingerollt
satin polished finish, rolled edge
acabado pulido satinado, borde redondeado
effet satin mat, bord rond

	cm	↑ cm
30119	23 x 23	1,5

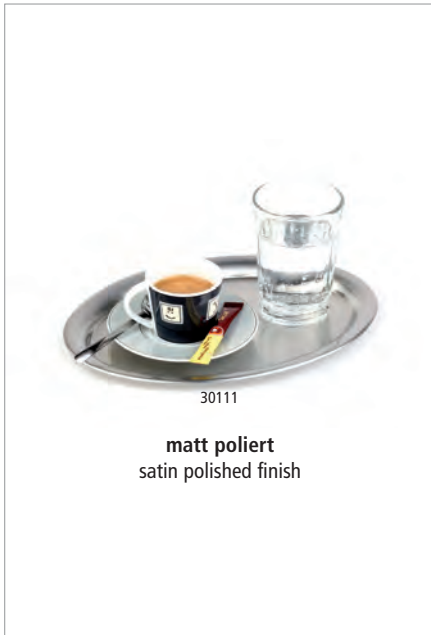

Serviertablett „KAFFEEHAUS“

tray
bandeja
plateau



matt poliert, oval, Rand eingerollt
satin polished finish, oval, rolled edge
pulido acabado efecto satinado, oval, borde redondeado
effet satin, ovale, bord rond

	cm	↑ cm	
30111	20,0 x 14,5	0,5	für Zucker und Sahne / for sugar and cream para azúcar y crema / pour le sucre et la crème
30112	26,5 x 19,5	0,5	für eine Tasse / for one cup para una taza / pour une tasse
30113	29,0 x 22,0	0,5	für zwei Tassen / for two cups para dos tazas / pour deux tasses
30123	23,0 x 17,5	0,5	Eisdielen-Größe / icecream pralor size tamaño especial para heladerías / taille spéciale pour glaciers



Serviertablett „KAFFEEHAUS“

tray
bandeja
plateau



hochglanzpoliert, oval, Rand eingerollt
mirror polished finish, oval, rolled edge
pulido efecto espejo, ovalado, borde redondeado
effet brillant, ovale, bord rond

	cm	↑ cm	
30115	20,0 x 14,5	0,5	für Zucker und Sahne / for sugar and cream para azúcar y crema / pour le sucre et la crème
30116	26,5 x 19,5	0,5	für eine Tasse / for one cup para una taza / pour une tasse
30117	29,0 x 22,0	0,5	für zwei Tassen / for two cups para dos tazas / pour deux tasses



Serviertablett „KAFFEEHAUS“

tray
bandeja
plateau



	cm	↑ cm	
30126	25,5 x 19,5	2	mattiert / satin polished finish acabado efecto satinado / fini mat effet satin



Rezeptionsglocke

ring bell
timbre
sonnette



	Ø cm	↑ cm	Farbe / Colour
71400	8,5	6,0	■
71433	10,0	6,5	■



Serviertablett „HAPPY HOUR“

tray
bandeja
plateau



rutschfeste Oberfläche
non-slip surface
superficie anti-deslizante
surface antidérapante

	Ø cm	↑ cm	Farbe / Colour
00510	32	1,5	■
00511	38	1,5	■
00515	43	1,5	■



Tablett „GASTRO“

tray
bandeja
plateau



rutschfeste Oberfläche
non-slip surface
superficie anti-deslizante
surface antidérapante

	Ø cm	↑ cm	Farbe / Colour
00547	27,5	2	■
00548	35,5	2	■
00549	40,5	2	■



Tablett „BISTRO“

tray
bandeja
plateau



rutschfest, mit 2 Griffmulden und Stapelrand
non-slip, two open handles, stackable edge
anti-deslizante, 2 asas
antidérapant, 2 anses

	Ø cm	↑ cm	Farbe / Colour
84045	35,5	4,5	■



Bierglaträger „NON-SLIP“

beer rack
bandeja para cerveza
porte verre à bière



rutschfeste Oberfläche
non-slip surface
superficie anti-deslizante
surface antidérapante

	Ø cm	↑ cm	Farbe / Colour
00500	36	3,5	■
00501	36	3,5	■

	cm	↑ cm	Farbe / Colour
00506	28 x 20	1,5	■
00507	28 x 20	1,5	■



Servierbrett, 2-tlg.
 serving board, 2 pcs.
 tabla de servir, set de 2
 planche de service, set de 2

SCHIEFER
SLATE

HOLZ
WOOD



2-teilig:
 1 Holzbrett aus Akazienholz + 1 Naturschieferplatte
 1 wood board made of acacia wood + 1 natural slate tray
 1 tabla de madera de acacia + 1 pizarra natural
 1 planche en bois d'acacia + 1 ardoise naturelle

	cm	↑ cm
00814	28 x 17,5	2,0



Servierbrett
 serving board
 tabla de servir
 planche de service



Servierbrett aus geöltem Akazienholz
 serving board made of oiled acacia wood
 tabla de servir de madera de acacia aceitada
 planche en bois avec plateau en bois d'acacia huilé

	cm	↑ cm
00897	30 x 15	2,0
00898	30 x 18	2,0
00899	35 x 25	2,0



Serviertablett „NON-SLIP“
 tray non-slip
 bandeja antideslizante
 plateau antiglisse



rutschfeste Oberfläche
 non-slip surface
 superficie antideslizante
 surface antidérapante

	cm	↑ cm	GN	Farbe / Colour
00502	53 x 32,5	1,5	1/1	■
00508	46 x 36,0	2		■
00505	53 x 32,5	1,5	1/1	■
00503	53 x 37,0	1,5		■



Tablett
 tray
 bandeja
 plateau
rutschfest, Holzdekor-Laminat
 non-slip, coated wood
 antideslizante
 antidérapant



	cm	↑ cm
00524	43,5 x 31,5	1,5
00525	52,0 x 39,0	1,5
00526	60,5 x 42,5	1,5



Fast Food-Tablett

snack tray
bandeja autoservicio y snacks
plateau self-service et snacks



	cm	↑ cm	GN	Farbe / Colour
00530	35 x 27,0	2		
00535	41 x 30,5	2		
00540	45 x 35,5	2		
00552	53 x 32,5	2	1/1	

	cm	↑ cm	GN	Farbe / Colour
00531	35 x 27,0	2		
00536	41 x 30,5	2		
00541	45 x 35,5	2		
00553	53 x 32,5	2	1/1	

	cm	↑ cm	GN	Farbe / Colour
00532	35 x 27,0	2		
00537	41 x 30,5	2		
00542	45 x 35,5	2		
00554	53 x 32,5	2	1/1	

	cm	↑ cm	GN	Farbe / Colour
00533	35 x 27,0	2		
00538	41 x 30,5	2		
00543	45 x 35,5	2		
00555	53 x 32,5	2	1/1	



Tablett

tray
bandeja
plateau



rutschfest, Mahagonifurnier
non-slip, woodform, mahogany
antideslizante
antidérapant

	Ø cm	↑ cm
00528	31,0	3,5
00529	35,5	3,5



rutschfest / non-slip



00522

Tablett

tray
bandeja
plateau



rutschfest, Holzdekor-Laminat
non-slip, coated wood
antideslizante
antidérapant

	cm	↑ cm
00521	26 x 20	1
00522	29 x 21	1



Rechnungstablent

bill presenter
porta cuenta
porte-addition



mit Klemme für Rechnung

with clip for bill
con clip para la nota
avec clip pour la note

	cm	↑ cm
30108	20 x 12	1,5



Rechnungstablent

bill presenter
porta cuenta
porte-addition



mit Klemme für Rechnung

with clip for bill
con clip para la nota
avec clip pour la note

	cm	↑ cm
30110	17 x 11	1



Tischkrümelentferner

crumber
recogemigas
ramasse-miettes



matt poliert

satín polished finish
acabado mate, fácil de usar, mango hueco
mat satiné, manche creux, simple à utiliser

	Ø cm	↑ cm	
00058	6,5 x 2,5	22	Hohlgriff / hollow handles
00581	19,5 x 4,5	1	geschliffene Edelstahlkante flat grinded stainless steel edge



Tablett

tray
bandeja
plateau



Tablett aus Edelstahl, hochglanzpoliert, stabiler Rand eingerollt
stainless steel tray, mirror polished finish, stable edge rolled in
bandeja de acero inoxidable, pulido efecto espejo, borde estable enrollado
plateau en acier inoxydable, effet brillant, bord stable enroulé

	cm	↑ cm
30148	Ø 27	1,5
30149	30 x 15,5	1,5



Windaschenbecher „DIAMOND“

ashtray
cenicero
cendrier

Metall verchromt, Glas gefrostet, mit Bajonettverschluss
metal chrome plated, glass frosted, bayonet lock
metal cromado, opaco mate, cierre de bayoneta
métal chromé, mat, verrouillage par baïonnette



	Ø cm	↑ cm	Farbe / Colour	
00565	12	8,0		Glas gefrostet / glass frosted
00566	12	8,0		Glas glänzend / glass shiny
00567	12	8,0		Glas glänzend / glass shiny



Windaschenbecher

ashtray
cenicero
cendrier

Metall verchromt, Glas gefrostet, mit Bajonettverschluss
metal chrome plated, glass frosted, bayonet lock
metal cromado, opaco mate, cierre de bayoneta
métal chromé, mat, verrouillage par baïonnette



	Ø cm	↑ cm	Farbe / Colour	
00560	9,5	8		Glas gefrostet / glass frosted
00561	9,5	8		Glas glänzend / glass shiny
00562	9,5	8		Glas glänzend / glass shiny
00563	9,5	8		Glas glänzend / glass shiny
00564	9,5	8		Glas glänzend / glass shiny

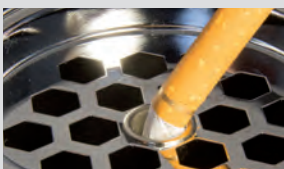



Drehaschenbecher „PUSH“

ashtray
cenicero
cendrier



Deckel mit Drehmechanismus, mit Bajonettverschluss
with rotary button, bayonet lock
con botón giratorio, cierre de bayoneta
tourne par pression sur le bouton, verrouillage par baïonnette

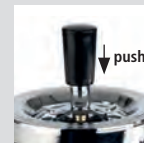

Drehmechanismus
rotary button

	Ø cm	↑ cm
00568	9,5	11



Windaschenbecher

ashtray
cenicero
cendrier



Metall verchromt, Glas gefrostet, mit Bajonettverschluss
metal chrome plated, glass frosted, bayonet lock
metal cromado, opaco mate, cierre de bayoneta
métal chromé, mat, verrouillage par baïonnette

	Ø cm	↑ cm	Farbe / Colour
00582	9,5	8	Black
00583	9,5	8	Yellow
00584	9,5	8	Teal
00585	9,5	8	White



Drehaschenbecher „KLASSIKER“

ashtray
cenicero
cendrier giratoire



Deckel mit Drehmechanismus
with rotary button
con botón giratorio
tourne par pression sur le bouton



Drehmechanismus
rotary button

	Ø cm	↑ cm	Farbe / Colour
00054	13,0	10,5	Grey
00056	10,5	11	Black



Aschenbecher

ashtray
cenicero
cendrier



Deckel hochglanzpoliert, Behälter matt poliert, mit Windschutzdeckel
lid mirror polished finish, container satin polished finish, with windcover
con tapa antiviento pulida brillante y contenedor pulido efecto satinado
couverture anti-vent brillant, corps poli mat satiné

	Ø cm	↑ cm
00052	12	5,5



Windaschenbecher

ashtray
cenicero
cendrier



	Ø cm	↑ cm	Farbe / Colour
83488	11,5	5	White
83489	11,5	5	Black



Windaschenbecher

ashtray
cenicero
cendrier



	Ø cm	↑ cm	Farbe / Colour
83610	10	4,0	White
83612	12	4,5	White
83611	10	4,0	Black
83613	12	4,5	Black



Aschenbecher

ashtray
cenicero
cendrier



	Ø cm	↑ cm	Farbe / Colour
83614	9,5	4,5	White
83616	9,5	4,5	Black



Aschenbecher

ashtray
cenicero
cendrier



matt poliert, mit Windschutzdeckel
satin polished finish, with windcover
acabado pulido satinado apilable, tapa para el viento
poli mat, empilable, couvercle anti-vent

	Ø cm	↑ cm
00090	10	4,5
00091	12	4,5



Aschenbecher

ashtray
cenicero
cendrier



matt poliert, hochwertige schwere Ausführung
satin polished finish, high quality, heavy gauge
pulido satinado, alta calidad, apilable
poli mat, empilable, belle qualité

	Ø cm	↑ cm
00048	8	3
00050	10	3



Windaschenbecher „SMOKY“

ashtray
cenicero
cendrier



Metall schwarz, mit abnehmbarem Deckel
metal black, with removable lid
metal negro, con tapa extraíble
métal noir, avec couvercle amovible

	Ø cm	↑ cm	Farbe / Colour	
00586	8,5	11,5	■	



Windaschenbecher „SMOKY“

ashtray
cenicero
cendrier



Metall verzinkt, mit abnehmbarem Deckel
metal galvanized, with removable lid
metal galvanizado, con tapa extraíble
métal galvanisé, avec couvercle amovible

	Ø cm	↑ cm	Farbe / Colour	
00578	8,5	11,5	■	



Windaschenbecher 4er Set „MINI“

ashtray, 4 pcs.
set de 4 cenicero
set de 4 cendriers



	Ø cm	↑ cm	pcs.	Farbe / Colour
83620	6,5	5,5	4	■
83621	6,5	5,5	4	■



stapelbar
stackable



Windaschenbecher „ELEMENT“

ashtray
cenicero
cendrier



Beton, mit möbelschonender Unterseite
concrete, with non-scratching undersurface
hormigón, con base anti rayaduras
béton, avec revêtement antirayures

	Ø cm	↑ cm	Farbe / Colour	
00570	10,5	5,0	■	



Aschenbecher, 3er Set

ashtray, 3 pcs.
set de 3 cenicero
set de 3 cendriers



	Ø cm	↑ cm	pcs.	Farbe / Colour
00576	8	3	3	■



Standascher „DIABOLO“

standing ashtray
cenicero de pie
cendrier sur pied



für den Innen- und Außenbereich, inkl. 1,5 kg Sand, eine Ascheschale für die Sandbefüllung und ein Metallsieb

for in,- outdoor use, included a bag of sand and a metal sieve

uso en interior o exterior, incluye una bolsa de arena y embudo de metal

usage en intérieur ou extérieur, livré avec un sac de sable et entonnoir métal

	Ø cm	↑ cm
00574	40	60



vielseitig nutzbar
versatile



zerlegbar und stapelbar
dismountable and stackable



Tretbeutelhalter

pedal bin
soporte a pedal
poubelle à pédale



geeignet für Müllbeutel bis 120 ltr., 110 x 70 cm

suitable for bags up to 120 ltr., 110 x 70 cm

apto para bolsas hasta 120 l, medidas sin bolsa 110 x 70 cm

apte pour sacs de 120 l, dim. sans sac 110 x 70 cm

	cm	↑ cm
00580	59 x 43	96



leichte Bedienung, Trittmehanismus
easy handling, step on type



2 Lenkrollen mit Feststellern
2 wheels with brakes

Gummilippe 55 cm breit, Abstand zwischen Gummilippe und Bodenblech 82 cm





Servier- & Küchenhelfer

serving items & kitchentools

herramientas de cocina

outils de cuisine



220°C
POLYAMID
 BEST TECHNOLOGY

Das Profimaterial Polyamid besteht aus Nylon und Fiberglas. Hitzebeständig bis 220°C, extra hochwertige Profi-Qualität, gut geeignet für antihafbeschichtete Pfannen, ergonomischer Griff.

Polyamide is made of nylon and fiberglass. Heat-resistant up to 220°C, extra high quality, perfect for non-stick-coated pots and pans, ergonomic handle.

Poliamide de nylon y fibra de vidrio. Brevemente al calor hasta 220°, calta calidad profesional, ideal para sartenes antiadherentes, mango ergonómico.

Polyamide de nylon et fibre de verre, haute résistance brièvement à la chaleur jusque 220°C, qualité professionnelle, idéal pour les poêles antiadhérentes, manche ergonomique.



Bratenwender

turner
 espátula
 spatule



	cm	Griff / handle cm
00603	11 x 9,5	23



Pfannenwender

turner
 espátula
 spatule



	cm	Griff / handle cm
00600	11,5 x 9,5	23



Pfannenwender

turner
 espátula
 spatule



	cm	Griff / handle cm
00604	15 x 7,5	15



Pfannenwender

turner
 espátula
 spatule



	cm	Griff / handle cm
88642	13,5 x 9	18



Pfannenwender

turner
 espátula
 spatule



	cm	Griff / handle cm
88640	13 x 6,5	15



Servierlöffel
 serving spoon
 cuchara de servicio
 cuillère de service



	cm	Griff / handle cm	
88608	12 x 7	23	
00607	12 x 7	23	perforiert



Schaumlöffel
 skimmer
 espumadera
 écumoire



	Ø cm	Griff / handle cm
00602	11,5	23



Schöpflöffel
 ladle
 cucharón
 louche



	Ø cm	Griff / handle cm	ltr.
00606	9	23	0,1



Toastzange
 sandwich tong
 pinza para sandwich
 pince à toasts



	cm	Griff / handle cm
00601	11 x 8	18



Spaghettizange
 spoon
 pinza espaguetis
 pince universelle ou à spaghettis



	cm	Griff / handle cm
88637	9 x 9	15



Salatzange
 salad tong
 pinza ensalada
 pince à salade



	cm	Griff / handle cm
00605	10 x 6	23

STOP-TOOLS

Die STOP-Funktion verhindert, dass Gabel oder Löffel in das Gefäß rutschen.

The smart STOP-function prevent forks and spoon not to slip into the vessel.

La función STOP evita que los cubiertos se caigan dentro del recipiente. Antideslizante.

La fonction STOP empêche les couverts de glisser dans le récipient.



Servierlöffel

serving spoon
cuchara de servicio
cuillère de service



Materialdicke 2,5 mm, ergonomischer, rutschfester Griff
ergonomic antislip handle
mango ergonómico antideslizante
manche ergonomique antidérapante

	cm	Griff / handle cm
00834	10 x 7,5	17



Servierlöffel geschlitzt

slotted spoon
cuchara de servicio
cuillère de service



Materialdicke 2,5 mm, ergonomischer, rutschfester Griff
ergonomic antislip handle
cuchara de servicio ranurada
cuillère de service rainurée

	cm	Griff / handle cm
00833	10 x 7,5	17



Schöpflöffel

ladle
cucharón
louche



Materialdicke 2,5 mm, ergonomischer, rutschfester Griff
ergonomic antislip handle
mango ergonómico antideslizante
manche ergonomique antidérapante

	Ø cm	Griff / handle cm
00832	9	17



Fleischgabel

meat fork
tenedor de carne
fourchette à viande



Materialdicke 2,5 mm, ergonomischer, rutschfester Griff
ergonomic antislip handle
mango ergonómico antideslizante
manche ergonomique antidérapante

	cm	Griff / handle cm
00831	10,5 x 4	17



Servierlöffel geschlitzt
 serving spoon
 cuchara de servicio ranurada
 cuillère de service rainurée



ergonomischer, rutschfester Griff
 ergonomic antislip handle
 mango ergonómico antideslizante
 manche ergonomique antidérapante

	cm	Griff / handle cm
00664	11 x 7	25



Servierlöffel
 serving spoon
 cuchara de servicio
 cuillère de service



ergonomischer, rutschfester Griff
 ergonomic antislip handle
 mango ergonómico antideslizante
 manche ergonomique antidérapante

	cm	Griff / handle cm
00662	11 x 7	25



Schöpföffel
 ladle
 cucharón
 louche



ergonomischer, rutschfester Griff
 ergonomic antislip handle
 mango ergonómico antideslizante
 manche ergonomique antidérapante

	cm	Griff / handle cm	ltr.
00670	9 x 8	25	0,10



Wender
 slotted turner
 espátula para plancha
 spatule pour le grill



ergonomischer, rutschfester Griff
 ergonomic antislip handle
 mango ergonómico antideslizante
 manche ergonomique antidérapante

	cm	Griff / handle cm
00668	10 x 8	25



Fleischgabel
 meat fork
 tenedor de carne
 fourchette à viande



ergonomischer, rutschfester Griff
 ergonomic antislip handle
 mango ergonómico antideslizante
 manche ergonomique antidérapante

	cm	Griff / handle cm
00666	10 x 3,5	25



Schöpflöffel „PROFI“

ladle
cacillo
louche



	Ø cm	Griff / handle cm	litr.
00711	6	28	0,050
00712	7	30	0,080
00713	8	32	0,125
00714	9	33	0,150
00715	10	35	0,250
00716	11	36	0,300



Schaumlöffel „PROFI“

skimmer
espumadera
écumoire



	Ø cm	Griff / handle cm
00721	10	34
00722	12	37
00723	14	40



Wender „PROFI“

turner
espátula
spatule



	cm	Griff / handle cm
00730	10 x 11,5	38



Servierlöffel „PROFI“

serving spoon
cuchara de servicio
cuillère de service



	cm	Griff / handle cm	
00671	11 x 7	29	geschlitzt / slotted
00672	11 x 7	29	



Spaghettilöffel „PROFI“

spaghetti spoon
cuchara de espaguetis
cuillère à spaghettis



	cm	Griff / handle cm
00673	10 x 7	29



Servierlöffel „CLASSIC“

serving spoon
cuchara de servicio
cuillère de service



hochglanzpoliert, perforiert, Löcher Ø 4 mm, ergonomisch profilierter Hohl-Griff
mirror polished finish, perforated, holes Ø 4 mm, ergonomic designed handle
pulido brillante agujeros de Ø 4 mm, asa ergonómica
brillant, trous Ø 4 mm, manche ergonomique

	cm	Griff / handle cm
75903	9,5 x 7	23,5



Salatlöffel „CLASSIC“

salad spoon
cuchara para ensalada
cuillère à salade



hochglanzpoliert, ergonomisch profilierter Hohl-Griff
mirror polished finish, ergonomic designed handle
inox brillante, asa ergonómica
brillant, manche ergonomique

	cm	Griff / handle cm
75902	8 x 6	21,5
75904	9,5 x 7	23,5



Suppenkelle „CLASSIC“

soup ladle
cucharón de sopa
louche de service



hochglanzpoliert, ergonomisch profilierter Hohl-Griff
mirror polished finish, ergonomic designed handle
pulido brillante, asa ergonómica
brillant, manche ergonomique

	Ø cm	Griff / handle cm	litr.
75907	7	23	0,06
75908	9	24	0,1



Saucengießlöffel „CLASSIC“

sauce / gravy ladle
cucharón de salsa
cuillère à sauce



hochglanzpoliert, ergonomisch profilierter Hohl-Griff, fugenlos
mirror polished finish, ergonomic designed handle, seamless
pulido brillante, asa ergonómica, sin soldadura
brillant, manche ergonomique, monobloc (sans soudure)

	cm	Griff / handle cm	litr.
75906	7 x 5,5	22	0,02



Tortenheber „CLASSIC“

cake lifter
pala de tartas
pelle à gâteau



hochglanzpoliert, mit einer gezahnten Kante, ergonomisch profilierter Hohl-Griff
mirror polished finish, one edge serrated, ergonomic designed handle
pulido brillante, canto dentado, mango ergonómico
brillant, bord microdenté, manche ergonomique

	cm	Griff / handle cm
75900	8 x 5	10,5
75912	5 x 1	12

BANQUET



Die Vorlegeserie BANQUET ist die passende Ergänzung zum Servieren am Buffet. Durch die mattierte Oberfläche und das gebogene Griffende wird BANQUET praktischen und optischen Ansprüchen gerecht.

The series BANQUET is the perfect addition for serving at the buffet. Due to the matt surface and the curved handle, BANQUET meets practical and optical requirements.

La serie BANQUET es la adición perfecta para servir en el buffet. Debido a la superficie mate y al mango curvado, BANQUET cumple con requisitos prácticos y ópticos.

La série BANQUET est l'ajout parfait pour servir au buffet. Grâce à la surface mate et la poignée incurvée, BANQUET répond aux exigences pratiques et optiques.



Salat- / Servierlöffel „BANQUET“

salad spoon / serving spoon
cuchara para ensalada / cuchara de servicio
cuillère à salade / cuillère de service



	cm	Griff / handle cm
00588	6 x 5	17
00590	7,5 x 6	21



Salatgabel „BANQUET“

salad fork
tenedor de servicio para ensalada
fourchette de service pour la salade



	cm	Griff / handle cm
00589	6 x 5	17
00591	7,5 x 6	21



Pfannenwender „BANQUET“

turner
espátula
spatule



	cm	Griff / handle cm
00587	10 x 7,5	21



Chafing Dish Löffel „BANQUET“

serving spoon
cuchara para servir
cuillère de service



	cm	Griff / handle cm	
00592	11 x 6,5	24	
00593	11 x 6,5	24	geschlitzt / slotted

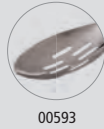

Dressinglöffel „BANQUET“

dressing spoon
cuchara de aliño
cuillère à vinaigrette



	cm	Griff / handle cm
00594	6 x 4	30



Schöpflöffel „BANQUET“

ladle
cucharón
louche



	cm	Griff / handle cm
00595	8,5 x 7,5	24



Fleischgabel „BANQUET“

meat fork
tenedor de carne
fourchette à viande



	cm	Griff / handle cm
00596	8 x 2,5	13



Serviergabel „BANQUET“

fork
tenedor de servicio
fourchette de service



	cm	Griff / handle cm
00597	9 x 4	21



Tortenheber „BANQUET“

cake lifter
pala de tartas
pelle à gâteau



eine Kante gezahnt
one edge serrated
un borde serrado
denté sur un côté

	cm	Griff / handle cm
00598	14 x 6	13



Salatzange „TIDLOS“

salad tong
pinza ensalada
pince à salade

hochglanzpoliert, einseitig geschlitzt
mirror polished finish, slotted on one side
acabado brillante, agujereada en un lado
brillant, perforée d'un seul côté



	cm	→ cm
75842	5 x 2	22



Pastazange „TIDLOS“

pasta tongs
pinza espaguetis
pince à spaghettis

hochglanzpoliert, beidseitig geschlitzt
mirror polished finish, slotted on both side
acabado brillante, agujereada en 2 lados
brillant, perforées des 2 côtés



	cm	→ cm
75843	8 x 5,5	22,5



Spargelzange „TIDLOS“

asparagus tongs
pinzas para espárragos
pince à asperges

hochglanzpoliert / mirror polished finish / acabado brillante / brillant



	cm	→ cm
75844	7 x 11	24,5



Gebäckzange „TIDLOS“

pastry tongs
pinza para pasteles
pince à gâteaux

hochglanzpoliert / mirror polished finish / acabado brillante / brillant



	cm	→ cm
75840	6,5 x 4,5	21



Servierzange „TIDLOS“

serving tongs
pinza universal
pince universelle

hochglanzpoliert / mirror polished finish / acabado brillante / brillant



	cm	→ cm
75841	7 x 4,5	21



Universalzange

all-purpose tong
pinza universal
pince universelle

Edelstahl, Antik-Edelstahl-Look / Vintage-Look

stainless steel, stainless antique look
acero inoxidable, acero estilo antiguo
acier inox, acier style antique



	cm	→ cm	Farbe / Colour	€
75825	7 x 5	22,5		vintage-look



Universalzange

all - purpose tong
pinza universal
pince universelle

hochglanzpoliert

mirror polished finish
acabado brillante
brillant



	cm	→ cm	Farbe / Colour	€
75830	7 x 5	25		mirror polished



Universalzange

all - purpose tong
pinza universal
pince universelle

hochglanzpoliert, Gold-Look

mirror polished finish, gold-look
pulido brillante, dorado
poli brillant, doré



	cm	→ cm	Farbe / Colour	€
75831	7 x 5	25		gold-look



Universalzange

all - purpose tong
pinza universal
pince universelle

hochglanzpoliert, Kupfer-Look

mirror polished finish, copper-look
pulido brillante, cobre
poli brillant, cuivre



	cm	→ cm	Farbe / Colour	€
75832	7 x 5	25		copper-look



Salatzange

salad tong
pinza ensalada
pince à salade

hochglanzpoliert, beidseitig geschlitzt / mirror polished finish, slotted on both side
acabado brillante, agujereada en 2 lados / brillant, perforéedes 2 côtés



	cm	→ cm	Farbe / Colour	€
75801	5 x 2	24		mirror polished



Spaghettizange

spaghetti tong
pinza espaguetis
pinçe à spaghettis

hochglanzpoliert, fugenlos
mirror polished finish, seamless
acabado brillante, sin soldaduras
brillant, monobloc



	cm	→ cm	
75810	6 x 3	19	



Vorspeisenzange „BANQUET“

appetizer tong
pinza para aperitivos
pinçe à apéritif

Vorderteil poliert, Stiel mattiert
front part: high-shiny, handle: matt-finish
parte delantera pulida, asa mate
partie avant polie, poignée matte



	cm	→ cm	€
75822	4,5 x 3,5	20	



Ideal für Vorspeisen
ideal for starters



Universalzange

all-purpose tong
pinza universal
pinçe universelle

Edelstahl, Antik-Edelstahl-Look / Vintage-Look
stainless steel, stainless antique look
acero inoxidable, acero estilo antiguo
acier inox, acier style antique



	cm	→ cm	€
75823	5,5 x 5,0	20	



Ideal für Geschnittenes
ideal for sliced products



Universalzange

all-purpose tong
pinza universal
pinçe universelle

Edelstahl, Antik-Edelstahl-Look / Vintage-Look
stainless steel, stainless antique look
acero inoxidable, acero estilo antiguo
acier inox, acier style antique



	cm	→ cm	€
75824	7 x 5	22,5	



Pinzettenzange

fine tong / tweezer
pinza de emplatar
pince à dresser



hochglanzpoliert, geriffelte Grifffläche, schwere Qualität
mirror polished finish, ribbed handle, heavy gauge
acabado brillante, mango cómodo ranurado, alta calidad
brillant, manche rainuré antiglisse, qualité extra

..... → cm
75820 16



Pinzettenzange

fine tong / tweezer
pinza de emplatar
pince à dresser



hochglanzpoliert, geriffelte Grifffläche, schwere Qualität
mirror polished finish, ribbed handle, heavy gauge
acabado brillante, mango cómodo ranurado, alta calidad
brillant, manche rainuré antiglisse, qualité extra

..... → cm
75821 30



Pinzettenzange

fine tong / tweezer
pinza de emplatar
pince à dresser



hochglanzpoliert, geriffelte Grifffläche, schwere Qualität
mirror polished finish, ribbed handle, heavy gauge
acabado brillante, mango cómodo ranurado, alta calidad
brillant, manche rainuré antiglisse, qualité extra

..... → cm
75809 30



Pinzettenzange

fine tong / tweezer
pinza de emplatar
pince à dresser



hochglanzpoliert, geriffelte Grifffläche, abgerundete Spitzen vorne, schwere Qualität
mirror polished finish, ribbed handle, rounded on the tops, heavy gauge
acabado brillante, mango cómodo ranurado, alta calidad, puntas redondeadas
brillant, manche rainuré antiglisse, qualité extra, pointes arrondies

..... → cm
75808 14,5



Salatzange
 salad serving tong
 pinza de ensalada
 pince à servir la salade



hochglanzpoliert, einfache Handhabung
 mirror polished finish, convenient handling
 pulido brillante, manejo cómodo
 brillant, manipulation aisée

	cm	→ cm
00685	7,0 x 4,5	25



Universalzange
 all - purpose tong
 pinzas multiusos
 pince multi-usages



hochglanzpoliert, einfache Handhabung
 mirror polished finish, convenient handling
 pulido brillante, manejo cómodo
 brillant, manipulation aisée

	cm	→ cm
00688	7,0 x 4,5	25



Brot- und Gebäckzange
 bread and pastry tong
 pinza para pan y bollería
 pince à pain ou viennoiseries



hochglanzpoliert, einfache Handhabung
 mirror polished finish, convenient handling
 pulido brillante, manejo cómodo
 brillant, manipulation aisée

	cm	→ cm
00686	7,0 x 4,5	25



Brot- und Gebäckzange
 bread and pastry tong
 pinza para pan y bollería
 pince à pain ou viennoiseries



hochglanzpoliert, einfache Handhabung
 mirror polished finish, convenient handling
 pulido brillante, manejo cómodo
 brillant, manipulation aisée

	cm	→ cm
00687	7,0 x 4,5	25



Aufschnitt- / Allzweckzange

sausage tong
pinza salchichas
pince à saucisses



hochglanzpoliert, fugenlos
mirror polished finish, seamless
pulido brillante, sin soldadura
brillant, monobloc

	cm	→ cm
75806	3 x 2,5	16



Allzweckzange

multipurpose tong
pinza multi-usos
pince universelle multi-usages



hochglänzend, mit Feder und Verschlusschieber, dekorative Greiferform
high-gloss finish, with spring and retaining clip, decorative gripper form
pulido brillante, con muelle y cierre deslizante, gancho con forma decorativa
finition brillante, avec mécanisme de verrouillage, forme de pince décorative

	cm	→ cm
88643	4 x 3	24
88644	4 x 3	30
88645	4 x 3	40



Universalzange

all - purpose tong
pinza universal
pince universelle



hochglanzpoliert, einseitig geschlitzt
mirror polished finish, slotted on one side
acabado brillante, agujereada en un lado
brillant, perforée d'un seul côté

	cm	→ cm
75800	5 x 2	24



Gebäckzange

pastry tong
pinza para pasteles
pince à gâteaux



hochglanzpoliert, fugenlos, extra schwere Qualität
mirror polished finish, seamless, extra heavy gauge
pulido brillante, sin soldadura, alta calidad, resistente
brillant, monobloc, qualité extra, robuste

	cm	→ cm
75807	8,5 x 4	27,5



Gebäck- / Tortenzange

pastry tong
pinza para pasteles
pince à gâteaux

hochglanzpoliert, fugenlos
mirror polished finish, seamless
acabado brillante, sin soldadura
brillant, monobloc



	cm	→ cm
75803	7 x 3,5	17,5



Gebäckzange

pastry tong
pinza para pasteles
pince à gâteaux

hochglanzpoliert, perforiert
mirror polished finish, perforated
pulido brillante, perforado
brillant, perforée



	cm	→ cm
75804	6,5 x 3	19,5



Eisportionierer

ice cream scoop
cuchara para helado
cuillère à glace

hochglanzpoliert, mit Edelstahlfeder (physikalisch bedingt nicht korrosionsbeständig)
mirror polished finish, spring steel, spring is not stainless
pulido brillante, muelle de acero especial, no resistente al óxido
poli brillant, ressort acier spécial, non résistant à l'oxydation



	∅ cm	→ cm	litr.
71006	6,5	23,5	1/12
71005	6,0	22,5	1/16
71004	5,5	22,0	1/20
71003	5,0	22,0	1/24
71002	5,0	21,5	1/30
71001	4,5	21,0	1/36



Messlöffelsatz

set measuring spoon
juego de cucharas medidoras
jeu de cuillère à mesure

Löffel hochglanzpoliert, Stiele matt poliert, Skalierung:
1 Esslöffel, 1 Teelöffel, 1/2 Teelöffel, 1/4 Teelöffel

bowl mirror polished finish, handles satin polished finish, measures:
table spoon, tea spoon, 1/2 tea spoon, 1/4 tea spoon

bol medidor brillante, mango mate medidas:

1 cuchara de sopa, 1 cuchara de té, 1/2 cuchara de té, 1/4 cuchara de té

corps brillant, manche mat, mesures:

1 cuillerée à soupe, 1 cuillerée à thé, 1/2 cuillère à thé, 1/4 de cuillère à thé



	cm
75600	14 x 4,5



Feinkostlöffel, 6er Set
 delicatessen spoon, 6 pcs.
 cuchara gourmet, set de 6
 cuillère gourmet, set de 6



aus Kunststoff
 plastic
 plástico
 plastique

	Ø cm	→ cm	pcs.	Farbe / Colour
88627	6	23	6	White



Feinkostlöffel, 6er Set
 delicatessen spoon, 6 pcs.
 cuchara gourmet, set de 6
 cuillère gourmet, set de 6



aus Kunststoff
 plastic
 plástico
 plastique

	Ø cm	→ cm	pcs.	Farbe / Colour
88628	6	23	6	Black



Feinkost- / Olivenlöffel, 6er Set
 delicatessen / olives spoon, 6 pcs.
 cuchara gourmet / para aceitunas, set de 6
 cuillère gourmet / à olives, set de 6



gelocht
 perforated
 perforadas
 perforées

	cm	→ cm	pcs.	Farbe / Colour
88598	6 x 9	27	6	Black

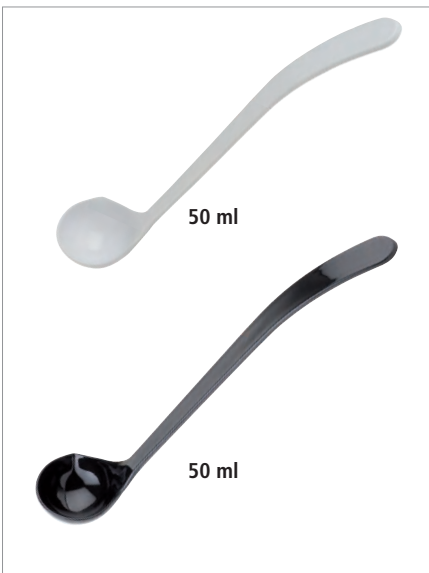

Dressinglöffel
 dressing spoon
 cuchara de aliño
 cuillère à sauce



aus Kunststoff
 plastic
 plástico
 plastique

	Ø cm	→ cm	ltr.	Farbe / Colour
88636	6	34	0,05	White
88609	6	34	0,05	Black

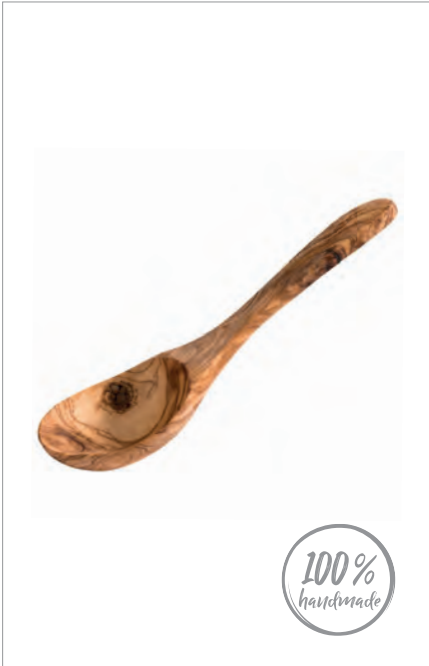

Löffel „OLIVE“

spoon
cuchara
cuillère

HOLZ
WOOD



aus Olivenholz, ideal für Reis, Gemüse...
olive wood, ideal for rice, vegetables...
madera de olivo, ideal para arroz, verduras...
en bois d'olivier, idéal pour le riz, les légumes...

	cm	→ cm
00840	9,5 x 8,5	17,0

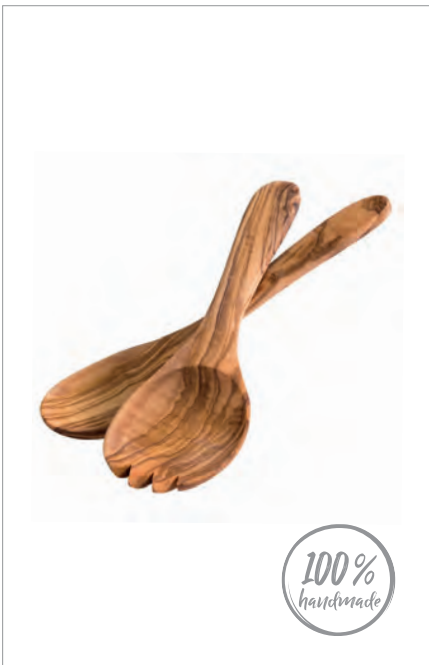

Salatbesteck „OLIVE“, 2er Set

spoon, 2 pcs.
cuchara, set de 2
cuillère, set de 2

HOLZ
WOOD



aus Olivenholz
olive wood
madera de olivo
en bois d'olivier

	cm	→ cm
00841	9,5 x 8,5	17,0

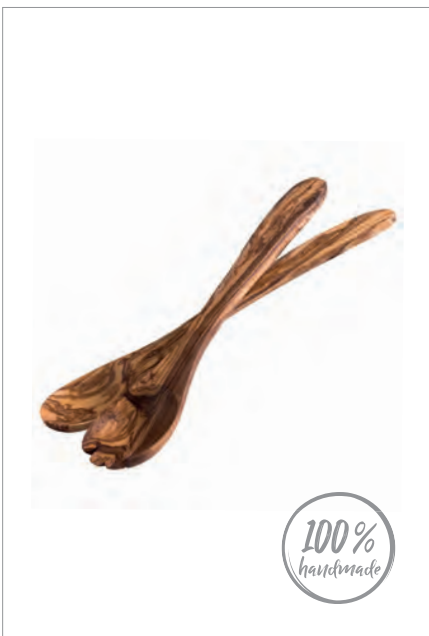

Salatbesteck „OLIVE“, 2er Set

spoon, 2 pcs.
cuchara, set de 2
cuillère, set de 2

HOLZ
WOOD



aus Olivenholz
olive wood
madera de olivo
en bois d'olivier

	cm	→ cm
00842	7,5 x 6,0	22,5





Löffel „ACACIA“

spoon
cuchara
cuillère



aus Akazienholz, ideal für Reis, Gemüse...
acacia wood, ideal for rice, vegetables...
madera de acacia, ideal para arroz, verduras...
bois d'acacia, idéal pour le riz, les légumes...

	cm	→ cm
00599	9 x 6,5	23,5



Löffel „OLIVE“, 2er Set

spoon, 2 pcs.
cuchara, set de 2
cuillère, set de 2



aus Olivenholz, ideal für Gewürze
olive wood, ideal for spices
madera de olivo, ideal para especias
en bois d'olivier, idéal pour les épices

	→ cm
01018	14



Honiglöffel „OLIVE“

honey spoon
cuchara de miel
cuillère à miel



aus Olivenholz
olive wood
madera de olivo
en bois d'olivier

	→ cm
01019	15



Schaufel „OLIVE“

scoop
pala
pelle



aus Olivenholz, ideal für Gewürze, Körner etc.
olive wood, ideal for spices, grains etc.
madera de olivo, ideal para especias, granos etc.
en bois d'olivier, idéal pour les épices, céréales, etc.

	→ cm
01020	13,5





Kugelausstecher - doppelt „ORANGE“

melon baller - double
vaciador doble de bola
moule à boule double



zum Formen von Kugeln aus Obst, Gemüse oder Butter, Edelstahl mit geschärften Rändern
to form balls out of fruits, vegetables, butter, etc., stainless steel with sharpened edge
para hacer bolas con frutas, verduras, mantequilla, etc. acero inoxidable con borde afilado
pour faire des boules de fruits, légumes, beurre, etc. inox, bord affûté

	∅ cm	→ cm
88810	2,2 + 2,5	16,5
88811	2,2 + 3,0	17



Fadenschneider / Zester „ORANGE“

decorator / zester
cuchillo de decoración cincelador
couteau zesteur



zum Abziehen von feinsten Schalenstreifen, ideal zum Dekorieren von Torten und Desserts
to peel off very fine stripes of paring, these stripes are ideal to decorate desserts, cakes, etc.
para pelar tiras muy finas, ideal para decorar postres, tartas, etc.
pour couper en lanières fines, idéal pour la décoration de gâteaux et desserts, etc.

	∅ cm	→ cm
88823	0,2 + 0,5	14,5



Ziseliermesser „ORANGE“

canele / decorating knife
cuchillo de decoración cincelador acanalado
couteau zesteur cannelé



zum Einritzen von Linien und Mustern in hartschaliges Obst und Gemüse, Edelstahl mit geschärften Rändern
to score lines or design in hard fruits and vegetables, stainless steel with sharpened edge
para dibujar líneas en frutas o verduras de piel dura, acero inoxidable con borde afilado
pour découper des lignes et motifs sur fruits et légumes à peau dure ou pour peler les zestes des citrons ou oranges, inox, bord affûté

	→ cm
88826	15



Sparschäler „ORANGE“

peeler
pelador
peleur



für Links- und Rechtshänder geeignet, mit zwei starren Klingen aus extra geschärftem + gehärtetem Edelstahl
useable left- and right handed, with 2 inflexible blades made out off sharpened, extra hardened stainless steel

para diestros y zurdos, con 2 cuchillas rígidas inox afiladas y muy resistentes
pour gauchers ou droitiers, 2 lames rigides affûtés en inox extra-résistant

	→ cm
88827	17



Pendelschäler „ORANGE“

swivel peeler
pelador reversible
éplucheur droitier/gaucher



für Links- und Rechtshänder, ideal für das Schälen von Tomaten, mit 2 beweglichen Klingen
suitable for right and left handed, ideal to peel tomatoes, with 2 flexibles blades
apto para diestros y zurdos, ideal para pelar tomates, con 2 hojas flexibles
pour gauchers ou droitiers, idéal pour peler les tomates, 2 lames flexibles

→ cm

88850 16,5



Cocktailmesser

bar knife
cuchillo para cóctel
couteau cocktail



mit 2 Zinken zum Aufspießen von Zitrusseiben
with 2 prongs to pick up slices of lemon
con 2 dientes para pinchar las rodajas de limón, etc.
avec 2 dents pour les rondelles de citron et autres décorations

→ cm

88846 21



Pizzateigschneider „ORANGE“

pizza cutter
cortador de pizza
roulette à pizza



zum einfachen Zerteilen von Pizza
to cut pizza easily
para cortar pizza fácilmente
pour une coupe facile de la pizza

Ø cm → cm

88829 6 18,5



Pendelschäler „ORANGE“

swivel peeler
pelador lama pivotante
peleur lame pivotante



zum schnellen und sparsamen Schälen von Obst und Gemüse, mit beweglicher Klinge
to peel fruits and vegetables with flexible blade
para pelar frutas y verduras con hoja flexible
pour couper des fruits et légumes avec lame flexible

→ cm

88834 17



Apfelentkerner „ORANGE“

apple corer
descorazonador de manzana
vide-pomme



durch leichtes Drehen kann das Kerngehäuse von Äpfeln, Birnen und anderen Früchten sorgsam herausgeholt werden, Edelstahl mit geschärften Rändern
with a light turn cores of apples, pears and other fruits can be cut off easily, stainless steel with sharpened edge
para descorazonar muy fácilmente manzanas, peras y otras frutas
pour évider facilement les pommes, poires ou autres fruits

Ø cm → cm

88836 2,2 21



Austernöffner „ORANGE“

oyster knife
 abre ostras
 couteau à huîtres



zum einfachen Aufbrechen von Austern, mit Fingerschutz, Edelstahl mit geschärften Rändern
 to open oysters easily, with guard, stainless steel with sharpened edge
 para abrir ostras fácilmente con protección para los dedos, acero inoxidable con punta afilada
 pour ouvrir facilement les huîtres avec protection pour les doigts, inox, pointe affûtée

.....
 → cm
 88839 14,5



Austernmesser „ORANGE“

oyster knife
 abre ostras
 couteau à huîtres



Edelstahl-Klinge zum Einstechen in die Schale, mit Fingerschutz
 to open oysters easily, with guard
 para abrir ostras fácilmente con protección para los dedos
 pour ouvrir facilement les huîtres avec protection pour les doigts

.....
 → cm
 88840 15



Dekoriermesser „ORANGE“

decorating knife „canalé“
 cuchillo acanalador
 couteau cannelé



gezahnte Klinge aus geschärftem Edelstahl
 serrated sharpened blade, stainless steel
 hoja de sierra afilada, acero inoxidable
 lame inox microdentée

.....
 → cm
 88843 19



Käsehobel „ORANGE“

cheese slicer
 rebanador de queso
 couteau tranche-fromage



zum Schneiden von dünnen Käsescheiben
 to cut thin slices of cheese
 para cortar lonchas finas de queso
 pour couper de fines tranches de fromage

.....
 → cm
 88853 21,5



Streichpalette „BLUE“

spatula
espátula
spatule



flexible Edelstahl-Klinge, rutschfester Griff, hitzebeständig
flexible blade stainless steel, non-slip handle, heat-resistant
hoja flexible acero inoxidable mango polipropileno termoresistente anti-deslizante
lame inox flexible, manche antiglisse en polypropilène thermorésistant

	cm	→	cm
88920	35 x 5		48,5
88921	30,5 x 4,5		43,5
88922	25 x 4		38,0
88923	20 x 3		33,5



Winkelpalette „BLUE“

spatula
espátula
spatule



flexible Edelstahl-Klinge
flexible blade stainless steel
hoja flexible acero inoxidable
lame inox flexible

	cm	→	cm
88928	17 x 5		30



Gebäckpalette „BLUE“

pastry spatuala
paleta pastelera
spatule pâtissière



flexible Edelstahl-Klinge
flexible blade stainless steel
hoja flexible acero inoxidable
lame inox flexible

	cm	→	cm
88932	17 x 7,5		29,5



Wender „BLUE“

turner
espátula
spatule



flexible Edelstahl-Klinge
flexible blade stainless steel
hoja flexible acero inoxidable
lame inox flexible

	cm	→	cm
88933	15 x 6		27,5



Winkelpalette „BLUE“

turner
espátula
spatule

flexible Edelstahl-Klinge
flexible blade stainless steel
hoja flexible acero inoxidable
lame inox flexible



	cm	→ cm
88935	34 x 5	47,5
88937	24 x 4	36
88938	18,5 x 3	32



Wender „BLUE“

turner
espátula
spatule

flexible Edelstahl-Klinge
flexible blade stainless steel
hoja flexible acero inoxidable
lame inox flexible



	cm	→ cm
88939	24 x 7,5	37,5



Wender „BLUE“

turner
espátula
spatule

perforiert, flexible Edelstahl-Klinge
perforated, flexible blade stainless steel
hoja flexible inox agujereada
lame ajourée inox flexible



	cm	→ cm
88940	24,5 x 7,5	37,5



Wender „BLUE“

turner
espátula para plancha
spatule

flexible Edelstahl-Klinge
flexible blade stainless steel
hoja flexible acero inoxidable
lame inox flexible



	cm	→ cm
88941	20 x 7,5	33
88942	15 x 9	28



Spachtel / Schaber „BLUE“

scraper
 espátula plancha
 spatule coudée spéciale grill

starre Edelstahl-Klinge
 rigid blade stainless steel
 hoja rígida acero inoxidable
 lame inox rigide



	cm	→ cm
88929	11 x 10	25



Spachtel / Fettabstecher „BLUE“

scraper
 espátula plancha
 spatule coudée spéciale grill

starre Edelstahl-Klinge
 rigid blade stainless steel
 hoja rígida de acero inoxidable
 lame rigide inox



	cm	→ cm
88946	17 x 10	30
88947	15 x 7,5	28



Aufstrichmesser „BLUE“

sandwich knife
 cuchillo para untar
 couteau à tartiner

flexible Edelstahl-Klinge
 flexible blade stainless steel
 hoja flexible acero inoxidable
 lame inox flexible



	cm	→ cm
88948	8,5 x 3	18,5



Teigschaber / Abstecher „BLUE“

dough scraper
 corta pasta
 coupe-pâte

starre Edelstahl-Klinge
 rigid blade stainless steel
 hoja rígida de acero inoxidable
 lame rigide inox



	cm
88930	15,5 x 8



Pizzaschneider „BLUE“

pizza cutter
cortador de pizza
coupe-pizza

ergonomischer Griff
ergonomic handle
mango ergonómico
manche ergonomique



	Ø cm	→ cm
88949	10	20

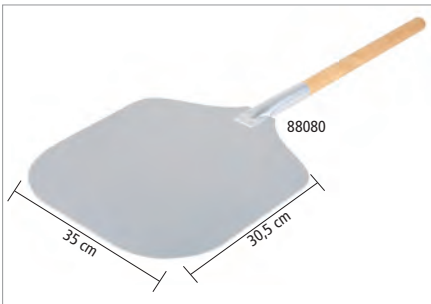

Pizzaschaufel

pizza peel
pala de pizza
pelle à pizza



	cm	→ cm
88080	35 x 30,5	90
88081	35 x 30,5	130



Eierschneider

egg cutter
corta huevos
coupe-oeufs

zum Längs- und Querteilen von hart gekochten Eiern
to cut hard-boiled eggs
corta a rodajas un huevo duro
en rondelles



	cm	↑ cm
88099	14,5 x 8	2,5



Hummerbrecher

lobster cracker
pinza bogavante
pince à homard



	cm
74201	14 x 5,5



Flambierbrenner

chefs blow torch
soplete de cocina para flambear
chalumeau de cuisine

mit handelsüblichem Feuerzeuggas auffüllbar, Flamme einstellbar bis ca. 1300° C, Brenndauer von min. 60 Minuten

to be filled with commercial lighter gas, flame adjustable up to approx. 1300° C, burning time of at least 60 minutes

rellenable con gas de mechero comercial, llama ajustable hasta 1300° C, tiempo de combustión de al menos 60 minutos

rempli avec gaz pour briquet commercial, flamme réglable jusqu'à 1300° C, temps de combustion d'au moins 60 minutes



	Ø cm	↑ cm
77315	4,5	16,5



Schneebesen

whisk
batidor
fouet



	Drähte / wires	→ cm
00744	8	28
00745	8	33
00746	8	38
00747	8	43
00740	8	48

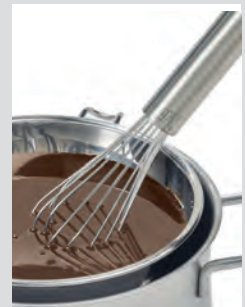

Passiersieb

strainer
colador
passoire



feines Siebgewebe mit ca. 6 Löchern pro 1 cm²
fine mesh with 6 holes per 1 cm²
malla fina con 6 agujeros por 1 cm²
toile fine avec 6 trous pour 1 cm²

	Ø cm	→ cm
74700	14	30
74701	16	32
74702	18	34
74703	20	36
74705	24	41
74706	26	43



Passiersieb

strainer
colador
passoire



mit Doppelnetz, Netz außen: ca. 2 Löcher pro 1 cm, Netz innen: ca. 5 Löcher pro 1 cm
with double mesh, outer mesh about 2 holes per cm, inner mesh about 5 holes per cm
con malla doble, malla exterior aprox. 2 agujeros /cm, interior aprox. 5 agujeros /cm
avec double étamine, extérieure env. 2 trous/cm, intérieure environ 5 trous/cm

	Ø cm	→ cm
74721	19,5	41,0
74722	24,5	56,5



Passiersieb

strainer
colador
passoire



feines Siebgewebe mit ca. 6 Löchern pro 1 cm²
fine mesh with 6 holes per 1 cm²
malla fina con 6 agujeros por 1 cm²
toile fine avec 6 trous pour 1 cm²

	Ø cm	→ cm
88617	26,0	56,5
88618	30,0	60,0
88639	33,5	62,5

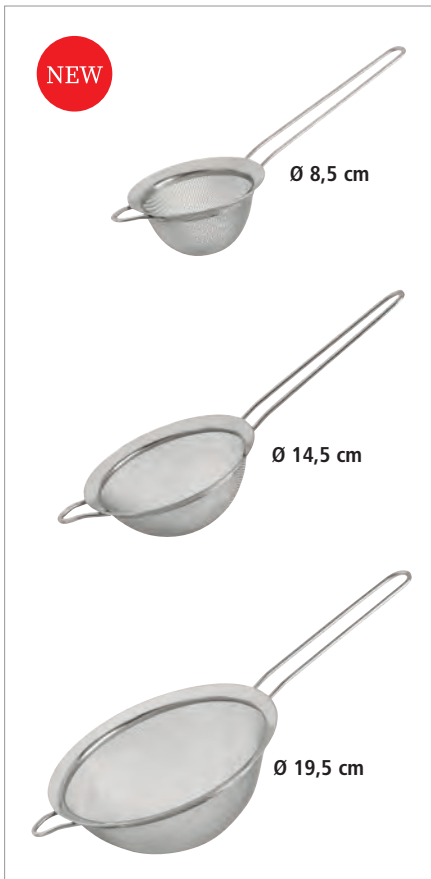

Passiersieb, 3er Set

strainer, 3 pcs.
colador, set de 3
passoire, set de 3



3-teiliges Set bestehend aus 3 Sieben:

Ø 8,5 cm, L: 22,5 cm / Ø 14,5 cm, L: 32 cm / Ø 19,5 cm, L: 38,5 cm

set of 3 consisting of 3 sieves:

Ø 8,5 cm, L: 22,5 cm / Ø 14,5 cm, L: 32 cm / Ø 19,5 cm, L: 38,5 cm

set de 3 que consta de 3 tamices:

Ø 8,5 cm, L: 22,5 cm / Ø 14,5 cm, L: 32 cm / Ø 19,5 cm, L: 38,5 cm

set de 3 composé de 3 tamis :

Ø 8,5 cm, L: 22,5 cm / Ø 14,5 cm, L: 32 cm / Ø 19,5 cm, L: 38,5 cm

	Ø cm	→ cm
74707	8,5/14,5/19,5	22,5/32/38,5

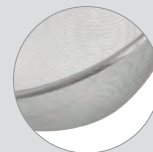

3 teilig
3 pcs. set



Seiher

strainer
colador
passoire



	Ø cm	↑ cm
74708	28,5	10

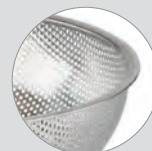



Back- / Frittierlöffel
skimmer / spider
espumadera para fritos
écumoire à friture



elektropoliert, sehr stabile Ausführung
electro polished, heavy gauge
electro pulido, alta calidad
poli électrolythique, qualité extra

	Ø cm	→ cm
74402	16	48
74404	20	54



Gazespitzsieb
conical strainer with wire gauze
colador chino de malla
chinois renforcé avec maille fine



hochglanzpoliert, mit rundem Hohlgriff, ca. 9 Löcher pro 1 cm²
mirror polished finish, 9 holes per 1 cm²
pulido acabado brillante, mango hueco, 9 agujeros por 1 cm²
brillant, manche creux, 9 trous pour 1 cm²

	Ø cm	↑ cm	Griff / handle cm
88717	25	19	24

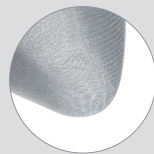

Pommes-Frites-Seiher
fry dripping tray
escurridor de fritos
égouttoir à friture



herausnehmbarer Locheinsatz, mit Handgriff
removable drainer, with handle
fondo de colador desmontable, con asa
fond démontable, avec poignée

	Ø cm	↑ cm
00785	39	19



Salzstreuer
salt shaker
salero
salière



Pommes-Frites Streuer mit Schraubkappe
for french fries, cover to screw
para patatas fritas, tapa de rosca
pour les frites, couvercle à visser

	Ø cm	↑ cm	
00772	8	17	stainless steel
00779	8	17	aluminium



Spitzsieb
conical strainer
colador cónico
chinois



mit Lochung Ø 1,5 mm, auch in der Kegelspitze, mit Flachstiel, mit Stützstiel zum Einhängen in den Topfrand

with Ø 1,5 mm holes (including the tip), with flat handle, with supporting hook
con agujeros finos de Ø 1,5 mm (incluida la punta), con mango plano y gancho
perforations fines 1,5 y compris à la pointe, manche plat et crochet

	Ø cm	↑ cm	Griff / handle cm
00771	23	18	16,5

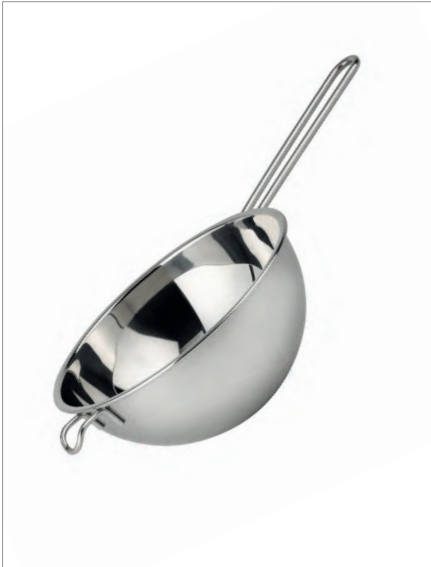

Wasserbadschüssel
bain marie bailing bowl
cazo para baño maría
récipient bain-marie



hochglanzpoliert, mit Drahtgriff Ø 5 mm
mirror polished finish, with wire handle Ø 5 mm
inox pulido brillante, mango varilla Ø 5 mm
inox brillant, manche fil épaisseur Ø 5 mm

	Ø cm	↑ cm	Griff / handle cm	ltr.
74731	18	9	15	1,5



Anwendungsbeispiel, Topf ≥ 20 cm
Application Example, pot ≥ 20 cm



Likör- und Fondanttrichter
confectionery funnel
embudo dosificador
entonnoir à piston



ergonomischer Griff aus Kunststoff, mit 3 Düsen 2, 4, 6 mm, inkl. Ständer u. Auffangschale
ergonomic plastic handle, with 3 different nozzles 2, 4, 6 mm, incl. wire rack a. dripping dash
mango ergonómico con 3 boquillas, 2, 4, 6 mm, incl. pie de alambre y bandeja recoge gotas
manche plastique ergonomique, 3 douilles de 2, 4 et 6 mm, inclut pied avec ramasse-gouttes

	Ø cm	↑ cm	ltr.
77338	20	34	1,5



Gemüsehobel, Mandoline
mandolin
mandolina
mandoline



mit 7 verschiedenen Klingen (Breite 10 cm), Anti-Rutsch-Gestell, Schutzabdeckung
with 7 interchangeable blades (width 10 cm), non-slip folding stand, safety guard
con 7 cuchillas intercambiables (corte 10 cm), pie plegable anti-deslizante, carro de seguridad
7 peignes interchangeables (largeur 10 cm), pied repliable anti-glisse, chariot

	cm	↑ cm
88688	40,5 x 12	5 / 25



A 7 verschiedene Klingen
7 interchangeable blades
B Praktische Transportbox
Practical transport box



Schaumspeisering
mousse ring
aro redondo para semifríos
cercle à mousse rond

matt poliert, fugenlos
satin polished finish, seamless
acabado satinado sin soldadura
mat satiné, sans soudure



	Ø cm	↑ cm
00098	6	4,5
00099	7	4,5
00092	8	4,5
00093	10	4,5
00094	12	4,5



Schaumspeiseringe, 5er Set
mousse ring, 5 pcs.
juego aros para emplatar o para semifríos
jeu de cercles à mousse inox, ronds

5-teilig: 4 Formen + 1 Verdichter, matt poliert, fugenlos
5 pcs. set: 4 shapes and 1 pusher, satin polished finish, seamless
juego de 5 piezas: 4 aros redondos y 1 pulsador, para dar forma, satinado sin soldadura
jeu de 5 pièces: 4 cercles et 1 poussoir. Idéal pour dressage sur assiette ou mousse, mat satiné, sans soudure



	Ø cm	↑ cm
00110	6	4,5
00113	8	4,5



Messbecher
graduated jug
jarra graduada
pichet gradué

außen hochglanzpoliert, innen matt poliert, mit Maßskalierung außen
outside mirror polished finish, inside satin polished finish, with stamped liter scale
exterior pulido brillante, interior satinado con escalado en litros
extérieur brillant, intérieur satiné, graduation en litres



	Ø cm	↑ cm	ltr.
30045	10	14	1

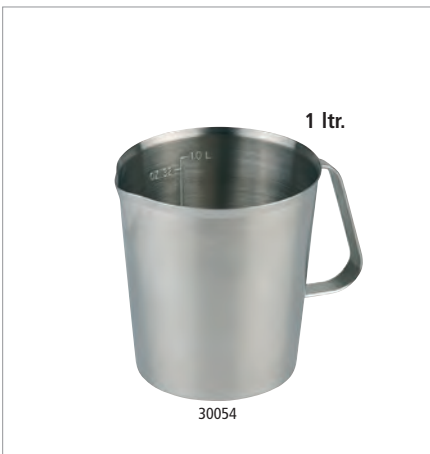

Mess- / Universalkanne
graduated jug
jarra medidora universal
pichet mesureur universel

matt poliert, mit Maßskalierung innen
satin polished finish, with stamped liter scale inner
acabado satinado, con graduación en el interior
mat, graduations à l'intérieur



	Ø cm	↑ cm	ltr.
30054	12	13	1
30055	14	17	2



Messbecher „PRO“

measuring cup
jarra graduada
pichet gradué



mit geschlossenem Griff, mit geprägter Maßskalierung außen, l- und ml-Liter-Einteilung
with closed handle, with stamped printed liter and ml scale

	Ø cm	↑ cm	ltr.
30046	9	14	0,5
30047	12	16,5	1,0
30048	15	20,5	2,0
30049	17	23,5	3,0
30057	20	25,5	5,0



Messbecher „STACKABLE“

measuring cup
jarra graduada
pichet gradué



mit offenem Griff und geprägter Maßskalierung außen, platzsparend stapelbar
with open handle and embossed dimension scaling on the outside, space-saving stackable
con asa abierta y escala de dimensiones en relieve en el exterior, apilable para ahorrar espacio
avec une poignée ouverte et une échelle de dimensions en relief à l'extérieur, empilable et peu encombrante

	Ø cm	↑ cm	ltr.
30059	7	12	0,25



offener Griff open handle einfaches Eingießen easy pouring stapelbar stackable

	Ø cm	↑ cm	ltr.
30061	9	14	0,5
30062	12	16,5	1,0
30063	15	20,5	2,0



Rührbecher mit Deckel

stirring cup with lid
vaso agitador con tapa
tasse à remuer avec couvercle



inklusive Spritzschutz und geprägter Maßskalierung außen, platzsparend stapelbar
included splash guard with open handle and embossed dimension scaling on the outside, space-saving stackable

protección contra salpicaduras incluida con asa abierta y escala de dimensiones en relieve en el exterior, apilable para ahorrar espacio

protection contre les éclaboussures incluse avec une poignée ouverte et une échelle de dimensions en relief à l'extérieur, empilable et peu encombrante

	Ø cm	↑ cm	ltr.
30058	12,5	16	1,0



Griff mit Daumenmulde handle with thumb recess mit Silikonring with silicone ring



Dariolformen, 2er Set

dariol moulds, 2 pcs.
juego 2 flaneras
jeu de 2 moules à flan



hochglanzpoliert
mirror polished finish
acabado brillante
brillant

	Ø cm	↑ cm	ltr.
00106	6,5	4,5	0,1



Tortenring

cake setting ring
aro de tarta
cercle à gâteaux



stufenlos verstellbar
adjustable
ajustables
ajustables

	Ø cm	↑ cm	
00040	16,5 - 32	7	ohne Griff / without handle



Backform

baking pan
marco pastelero
forme à gateaux



stufenlos verstellbar, aus flexiblem Edelstahl
adjustable
ajustable
ajustable

	cm	↑ cm
00042	19 x 28 - 34 x 54	5



Ausstellblech / Thekenblech

display tray
bandeja pastelera
plaque pâtissière



hitzebeständig bis 230°C
heat-resistant up to 230°C
resistente al calor hasta 230 °C
résistant à la chaleur jusqu'à 230°C

	cm	↑ cm
13377	40 x 25	2
13378	48 x 32	2
13379	60 x 40	2



Mehlschaufel „PRO“

scoop
pala
pelle à farine



stehende Schaufel, auch für Flüssigkeiten geeignet
standing scoop, also applicable for liquids
pala, apto también para líquidos
adaptée pour poudres et liquides

	cm	↑ cm	ltr.	Farbe / Colour
00610	25 x 9	4,5	0,25	White
00611	31 x 12	5,5	0,5	White
00612	35 x 13	6	0,7	White



Seiher

strainer
colador
passoire



mit 2 Muschelgriffen
with 2 shell shaped grips
con dos asas
à 2 anses moulées

	Ø cm	↑ cm
00780	36	19



Backhandschuhe

baking mittens
manoplas de panadero
gants de boulanger

Leder, gefüttert, Einheitsgröße, mit Stulpen, extrem hitzebeständig bis 250°C
leather, inner lining, one size, with cuffs, extremely heat resistant up to 250°C
cuero interior forrado, talla única, resiste a temperaturas hasta 250°C
cuir intérieur doublé, taille unique, résiste à maxi 250°C

	→ cm
88090	45



Pizzaschaufel

pizza peel
pala de pizza
pelle à pizza



	cm	→ cm
88080	35 x 30,5	90
88081	35 x 30,5	130



Schaufel „ECO“

scoop
pala
pelle



stabil und bruchsicher
stable and unbreakable
estable e irrompible
stable et incassable

	→ mm	ltr.
00694	180	0,110
00695	240	0,230
00696	310	0,470
00697	330	0,725



Zum schnellen und zielgerichteten Abfüllen von Lebensmitteln
for fast and targeted filling of foodstuffs



Profi-Eimer

bucket
cubo
seau



mit Ausgießer und geprägter Maßskalierung innen
with spout and embossed dimension scaling inside
con pico y escala de medición en relieve en el interior
avec bec verseur et échelle de mesure en relief à l'intérieur

	Ø cm	↑ cm	ltr.	Farbe / Colour
30075	28,5	28,5	10,5	White
30076	33,0	32,0	17,0	White
30077	28,5	28,5	10,5	Black
30078	33,0	32,0	17,0	Black



mit Griff
with handle

Maßskalierung innen
dimension scaling inside

Auslaufnase für sicheres Handling
discharge nose for safe handling



Eier-Box

eggs box
caja para huevos
boîte à oeufs



mit luftdichtem Deckel, für 4 Lagen à 30 Eier, Lieferung inkl. 8 Lagen, Größe Lage: 28 x 28 cm
with airtight cover, capacity: 4 trays of 30 eggs, delivery with 8 trays, size of tray: 28 x 28 cm
capacidad para 4 bandejas de 30 huevos, tapa hermética, se entrega con 8 bandejas, formato bandejas 28 x 28 cm, apto para lavavajillas
pour 4 plateaux de 30 oeufs chacun, apte pour 4 plateaux plats, couvercle hermétique, livré avec 8 plateaux, dimension plateau 28x28 cm, lavable en lave-vaisselle

	cm	↑ cm	GN
82419	35,4 x 32,5	20	2/3

NEW

Ø 6 cm



30065

Ø 10 cm



30067

Ø 12 cm



30068

Ø 17 cm



30070

inkl. Sieb
incl. strainer

Ø 21 cm



30071

inkl. Sieb
incl. strainer

Trichter „PROFI“

funnel
embudo
entonnoir

mit Öse
with eyelet
con ojal
avec œillet



	Ø cm	Ø mm Durchlass	
30065	6	8	
30066	8	11	
30067	10	12	
30068	12	12	
30069	14	15	
30070	17	17	mit Sieb / incl. strainer
30071	21	20	mit Sieb / incl. strainer



30066

erleichtert das Einfüllen
facilitates filling



30065

Anwendungsmöglichkeit
applicability



30070

mit einsetzbarem Sieb
incl. insertable strainer



Ø 20 mm

30071

mit einsetzbarem Sieb
incl. insertable strainer



2 Pressringe für Zitrone und Limette

Limetten- / Zitronenpresse
lime- / lemonpress
exprimidor de limón / lima
presse citron



	cm	↑ cm
93214	21 x 7	5



Limettenpresse
lime press
prensa de limón
presse citron



	cm	↑ cm
93189	21 x 7	5



Zitruspresse
citrus squeezer
exprimidor cítricos
presse-citron



hochglanzpoliert, 2-teilig
mirror polished finish, 2 pcs.
pulido brillante, 2 piezas
brillant, 2 pièces

	Ø cm	↑ cm	ltr.
71431	12 / 17	10,5	0,35



77350

77352

Pinsel
brush
brocha
pinceau pâtissier



weißgebleichte, naphtalinfreie Borsten, temperaturbeständig von -40°C bis +95°C
bleached bristles, heat-resistant from -40°C to +95°C
cerdas blanqueadas, resistencia térmica -40°C hasta +95°C
soies blanchies sans naphtaline, résistance de - 40°C à + 95°C

	cm	→ cm
77350	4 x 1	23,5
77352	6 x 1	24



einhängbar
hookable

Panierstation, 3-teilig
breading set, 3 pcs. set
estación de empanado, set de 3
station de panure, set de 3



zum Panieren von Fleisch, Gemüse, Käse etc.
for breading meat, vegetables, cheese etc.
para empanar carne, verduras, queso, etc.
pour paner la viande, les légumes, le fromage etc.

	cm	↑ cm
66904	45,5 x 18	2,5



Bonspieß

bill spike
pinchanotas
pique-bons



Spieße aus flexiblem Kunststoff, mit stumpfen Enden zur Unfallverhütung
spikes made of flexible plastic, with blunt ends to prevent accidents
pinchos de plástico flexible
piques en plastique flexible

	cm	↑ cm
88855	9 x 5,5	10,5



Bonleiste

bill rail
portafichas
barre porte-bons



matt poliert, mit Kugel-Greifsystem, zur Wandmontage geeignet, auch mit Magneten nutzbar
satin polished finish, small balls hold the bills, suited for wall fastening, can also be used with magnets
acabado satinado, con sistema de bolas para colgar las notas para fijar en la pared, puede usarse con imán
mat satiné, avec billes pour fixer sans effort tous types de fiches et papiers, peut se fixer sur plaque aimantée

	cm	↑ cm
88900	40 x 8	2
88901	50 x 8	2
88902	60 x 8	2



Magnet-Messerhalter

magnetic knife rack
barra magnética para cuchillos
barre aimantée pour couteaux



mit 2 Magnetschienen und Haken, aus massivem Kunststoff, zur Wandmontage geeignet, Lieferung ohne Deko
with 2 magnet racks and hooks, strong plastic, suited for wall fastening
con 2 railes magnéticos y ganchos, plástico macizo, fijación en pared
avec 2 rails aimantés et crochets, plastique robuste, fixation murale

	→ cm
88911	45
88912	60



Folien-Abreißvorrichtung

clingfilm tear-off-dispenser
dispensador de film
dérouleur de film



mit Abreißkante / Säge-Messer, für Endlosfolie, als Tischgerät oder Wandgerät verwendbar
with saw, for endless rolls, can be fixed on the wall
con sierra para rollo de film continuo, se puede fijar en la pared
avec lame dentée pour rouleau de film, peut être fixé au mur

	cm	↑ cm	
88288	34 x 16	9	für Folienbreite 30 cm / for film width 30 cm para film ancho 30 cm / pour film largeur 30 cm
88287	49 x 16	9	für Folienbreite 45 cm / for film width 45 cm para film ancho 45 cm / pour film largeur 45 cm



Schneidbrettständer
cutting board rack
soporte para tablas
rack pour planches à découper



für 6 Schneidbretter bis 25 mm Stärke, Lieferung ohne Deko
for 6 chopping boards up to 25 mm thickness
para 6 tablas de corte de 25 mm
pour 6 planches de 25 mm

	cm	↑ cm
88903	27 x 31	28



Eiswaffel-Ständer
cornet stand
soporte cucuruchos
support à cornets



matt poliert, mit 4 Löchern, 2 x Ø 31 mm + 2 x Ø 26 mm
satin polished finish, with 4 holes, 2 x Ø 31 mm + 2 x Ø 26 mm
acero inoxidable con 4 agujeros 2 x Ø 31 mm + 2 x Ø 26 mm
inox, 4 trous - 2 x Ø 31 mm + 2 x Ø 26 mm

	cm	↑ cm
11881	27,5 x 9,5	9



Eisportionierer
ice cream scoop
cuchara para helado
cuillère à glace



hochglanzpoliert, mit Edelstahlfeder (physikalisch bedingt nicht korrosionsbeständig)
mirror polished finish, spring steel, spring is not stainless
pulido brillante, muelle de acero especial, no resistente al óxido
poli brillant, ressort acier spécial, non résistant à l'oxydation

	Ø cm	→ cm	ltr.
71006	6,5	23,5	1/12
71005	6,0	22,5	1/16
71004	5,5	22,0	1/20
71003	5,0	22,0	1/24
71002	5,0	21,5	1/30
71001	4,5	21,0	1/36



Quetschflasche „MINI“, 4er Set
squeeze bottle, 4 pcs.
bote dosificador flexible, 4 pz.
bouteille verseuse souple, 4 pc.



mit Schraubdeckel und Verschlusskappe, ideal für Dressing und Saucen
with tight-screw and cap, ideal for dressing and sauce
con tapa de rosca y tapón, ideal para aliño y salsas
avec couvercle à visser et bouchon de fermeture, idéal pour vinaigrette et sauces



	Ø cm	↑ cm	ltr.	pcs.
93225	3,0	8,5	0,03	4
93226	3,5	9,5	0,05	4

NEW

93259 1,025 ltr. 93260 1,025 ltr. 93261 1,025 ltr.

Quetschflasche
squeeze bottle
bote dosificador flexible
bouteille verseuse souple

mit Schraubdeckel und Verschlusskappe, ideal für Dressing und Saucen
with tight-screw and cap, ideal for dressing and sauce
con tapa de rosca y tapón, ideal para aliño y salsas
avec couvercle à visser et bouchon de fermeture, idéal pour vinaigrette et sauces

PE POLYETHYL

	Ø cm	↑ cm	ltr.	Farbe / Colour
93259	8	26,5	1,025	White
93260	8	26,5	1,025	Yellow
93261	8	26,5	1,025	Red

große „Öffnung“
big „mouth opening“

93155 0,65 ltr. 93156 0,65 ltr. 93157 0,65 ltr.

Quetschflasche
squeeze bottle
bote dosificador flexible
bouteille verseuse souple

mit Schraubdeckel und Verschlusskappe, ideal für Dressing und Saucen
with tight-screw and cap, ideal for dressing and sauce
con tapa de rosca y tapón, ideal para aliño y salsas
avec couvercle à visser et bouchon de fermeture, idéal pour vinaigrette et sauces

PE POLYETHYL

	Ø cm	↑ cm	ltr.	Farbe / Colour
93155	6,5	24	0,65	Yellow
93156	6,5	24	0,65	Red
93157	6,5	24	0,65	White

93154

Quetschflasche
squeeze bottle
bote dosificador flexible
bouteille verseuse souple

ideale Größe, um Speiseteller mit Saucen zu verzieren, mit Verschlusskappe
ideal size to garnish plates with sauces, with cap
tamaño ideal para decorar platos con salsas, con tapón
taille idéale pour décorer assiettes avec des sauces, avec bouchon

PE POLYETHYL

	Ø cm	↑ cm	ltr.
93154	5	16	0,2
93163	6	21	0,35

NEW



93253
0,49 ltr.



93251
0,26 ltr.



93258
0,76 ltr.

Quetschflasche, 6er Set

squeeze bottle, 6 pcs.
bote dosificador flexible, set de 6
bouteille verseuse souple, set de 6



mit Schraubdeckel und Verschlusskappe, ideal für Dressing und Saucen

with tight-screw and cap, ideal for dressing and sauce

con tapa de rosca y tapón, ideal para aliño y salsas

avec couvercle à visser et bouchon de fermeture, idéal pour vinaigrette et sauces

	Ø cm	↑ cm	ltr.	Farbe / Colour	pcs.
93250	5	18,0	0,26		6
93251	5	18,0	0,26		6
93252	5	18,0	0,26		6
93253	7	20,0	0,49		6
93254	7	20,0	0,49		6
93255	7	20,0	0,49		6
93256	7	26,5	0,76		6
93257	7	26,5	0,76		6
93258	7	26,5	0,76		6



mit Verschlusskappe
with cap



große „Öffnung“
big „mouth opening“

NEW



93270
0,35 ltr.



93271
0,35 ltr.



93272
0,35 ltr.



93273
0,75 ltr.



93274
0,75 ltr.



93275
0,75 ltr.

Quetschflasche „NON DRIP“

squeeze bottle
bote dosificador flexible
bouteille verseuse souple



mit Schraubdeckel und Verschlusskappe, ideal für Dressing und Saucen

with tight-screw and cap, ideal for dressing and sauce

con tapa de rosca y tapón, ideal para aliño y salsas

avec couvercle à visser et bouchon de fermeture, idéal pour vinaigrette et sauces

	Ø cm	↑ cm	ltr.	Farbe / Colour
93270	5,5	21,0	0,35	
93271	5,5	21,0	0,35	
93272	5,5	21,0	0,35	
93273	7,0	25,5	0,75	
93274	7,0	25,5	0,75	
93275	7,0	25,5	0,75	



mit Skalierung
with scaling



tropffrei
non drip



Dosierspender
dispenser
dispensador de salsa
doseur à sauce



	cm	↑ cm	ltr.	GN
93280	17,6 X 16,2	27	2,6	1/6



Dosierpumpe / dosing pump / riser tube / bomba de salsa, sola / pompe à sauce

Hubvolumen 30 ml
swept volume 30 ml
cada dosis 30 ml
30 ml par dose

	cm	↑ cm	ltr.	
93281	12,5 X 4,5	26	0,30	fits to 93280



Dosierspender
dispenser
dispensador de salsa
doseur à sauce



	cm	↑ cm	ltr.
93151	13 x 7,5	27	1,25



Dosierpumpe / dosing pump / riser tube / bomba de salsa, sola / pompe à sauce

Hubvolumen 30 ml
swept volume 30 ml
cada dosis 30 ml
30 ml par dose

	Ø cm	↑ cm
88271	4,5	40



Gewürzkasten
condiment container
especiero
boîte à épices ou ingrédients



matt poliert, 4 herausnehmbare Einsatzschalen je 0,5 l, Scharnierdeckel aus Acryl
satin polished finish, 4 removable inserts each 0,5 ltr., acrylic lid
acabado mate, 4 contenedores extraíbles de 0,5 L cada uno, tapa con bisagras de acrílico
poli mat, 4 compartiments amovibles de 0,5 l chacun, couvercle rabattable en acrylique

	cm	↑ cm	ltr.
71700	31 x 15,5	9,5	4 x 0,5

Einsatzschale / insert / contenedor 0,5 L / récipient 0,5 L

	cm	↑ cm	ltr.
71701	14 x 7,5	7	0,5



NEW

Pizzaform

11 sizes



Pizzaform
pizza dish
molde de pizza
moule à pizza



Blaublech, nicht beschichtet, lange Lebensdauer, hitzebeständig bis 360 °C
metal sheet, without coating, long endurance, heat resistant up to 360 °C
chapa azul, sin revestimiento, larga vida útil, resistente al calor hasta 360 °C
métal, sans revêtement, longue durée de vie, à la chaleur jusqu'à 360 °C

	Ø cm	↑ cm	* mm
73502	16 - 18	2,5	1
73503	18 - 20	2,5	1
73504	20 - 22	2,5	1
73505	22 - 24	2,5	1
73506	24 - 26	2,5	1
73507	26 - 28	2,5	1
73508	28 - 30	2,5	1
73509	30 - 32	2,5	1
73510	34 - 36	2,5	1
73511	38 - 40	2,5	1
73513	48 - 50	3,0	1



stapelbar
stackable

NEW



Gestell für Pizzaformen

rack for pizza pans
rejilla para pizzas
support pour moules à pizza



Edelstahlgestell zusammenklappbar für Pizzaformen Ø 28 cm,
Abstand zwischen den Ebenen 5,5 cm

foldable stainless steel rack for pizza dishes ø 28 cm,
distance between the levels 5.5 cm

rejilla plegable de acero inoxidable para moldes de pizza de Ø 28 cm,
distancia entre los niveles 5,5 cm

support en acier inox pliable pour les moules à pizza de Ø 28 cm,
distance entre les niveaux 5,5 cm

	cm	↑ cm
73515	26 x 25	26



Backofen geeignet
suitable for oven



Pizzaform für Ø 28 cm
pizza dish for Ø 28 cm



Pizzaform / pizza dish / molde de pizza / moule à pizza

	Ø cm	↑ cm	mm
73507	26 / 28	2,5	1

Korkuntersetzer

cork mat
salvamanteles
dessous-de-plat liège



ideal für Servier- und Eisenpfannen

ideal for iron pan

ideal para servir en sartenes de chapa

idéal pour présenter les poêles forgées sur table



	Ø cm	↑ cm
73750	24	2



Teig- und Pizzaballenbehälter
dough and pizza ball container
recipiente para masa y bolas de pizza
récipient à pâte et boules à pizza



Innenmaß 56,5 x 36,5 cm, H: 7 cm
inner dimension 56,5 x 36,5 cm, H: 7 cm
medida interior 56,5 x 36,5 cm, H: 7 cm
dimension intérieure 56,5 x 36,5 cm, H: 7 cm

	cm	↑ cm	ltr.
82440	60 x 40	7,5	14



stapelbar
stackable

passender Deckel / fitting lid / tapa adecuada / couvercle approprié

	cm	↑ cm
82441	60 x 40	1



Pizzaform
pizza dish
molde de pizza
moule à pizza



Blaublech, rechteckig, Rand umgelegt, hitzebeständig bis 360 °C
blue steel baking sheet, rectangular, heat resistant up to 360 °C
chapa azul rectangular, borde plgado, resistente al calor hasta 360 °C
métal, rectangulaire, bord plié, à la chaleur jusqu'à 360 °C

	cm	↑ cm
88256	60 x 40	2,5



Pizzaschneider „BLUE“
pizza cutter
cortador de pizza
coupe-pizza



ergonomischer Griff
ergonomic handle
mango ergonómico
manche ergonomique

	Ø cm	→ cm
88949	10	20



Aufsteller „ACHTUNG RUTSCHGEFAHR“
stand
letrero
panneau



	cm	↑ cm	Farbe / Colour
71421	30 x 63	63	Yellow





Hauben & Zubehör

covers & accessories
campanas & accesorios
cloches & accessoires

QUALITÄTSHAUBEN

11042
GN 1/111041
GN 1/211043
GN 1/311044
GN 2/411041
GN 1/211042
GN 1/1

GN Abdeckhaube

GN cover
GN cubierta
GN cloche



passend für GN Tablett, glasklarer Kunststoff, nahezu bruchfest

suitable for GN trays, clear plastic, nearly unbreakable

apto para bandejas GN, plástico transparente, muy resistente a la rotura

pour bacs et plateaux GN, plastique transparent, très résistant à la casse

	cm	↑ cm	∕ mm	GN
11043	32,5 x 17,6	10,5	3	1/3
11044	53,0 x 16,2	10,5	3	2/4

	cm	↑ cm	∕ mm	GN
11041	32,5 x 26,5	9,5	3	1/2
11042	53,0 x 32,5	9,5	3	1/1



stapelbar
stackable



GN 1/1 Haube „HOCHSTAPLER“

GN 1/1 cover
GN 1/1 campana
GN 1/1 cloche



glasklarer Kunststoff, Tablett fixiert sich auf der Haube - kein Rutschen möglich, nahezu bruchfest

clear plastic, tray fixes itself on the cover and can not slip off, nearly unbreakable

plástico transparente, la bandeja se fija a la tapa para que no se deslice, muy resistente a la rotura

en plastique transparent, le plat se fixe sur le dessous de la cloche pour ne pas glisser, très résistant à la casse

	cm	↑ cm	GN	fits to
11305	53 x 32,5	9	1/1	11300, 11290, 11295



GN Kuppelhaube

GN cover
GN cúpula
GN cloche bombée



glasklarer Kunststoff, Griff aus Zinkdruckguss

crystal clear plastic, die-cast zinc knob

plástico transparente, asa de zinc fundido a presión

plastique transparente, poignée en zinc moulé sous pression

	cm	↑ cm	GN	
11021	33 x 28	17	1/2	geschlossen / totally closed cerrada / totement fermée
11022	33 x 28	17	1/2	mit Front-Ausschnitt / one long side cut out gran apertura frontal grande ouverture frontale
11026	54 x 33	20	1/1	geschlossen / totally closed cerrada / totement fermée
11027	54 x 33	20	1/1	mit Front-Ausschnitt / one long side cut out gran apertura frontal grande ouverture frontale
11028	54 x 33	20	1/1	mit seitlichem Ausschnitt / one small side cut out pequeña apertura lateral petite ouverture latérale



stapelbar
stackable



GN 1/1
and
GN 1/2

GN Rolltophaube

GN rolltop cover
GN campana rolltop
GN cloche rolltop



patentiert, passend für GN-Behälter, -Tablets, etc., leichtgängig auf- und zuklappbar 90°
patented, suitable for GN trays, solid quality, 90° opening
patentada, para bandejas GN, apertura 90°
brevetée, pour plateaux GN, ouverture 90°

	cm	↑ cm	GN	
11008	53,0 x 32,5	19	1/1	vergoldeter Griff / gold plated handle pomo dorado / bouton doré
11010	53,0 x 32,5	19	1/1	verchromter Griff / chrome plated handle pomo cromado / bouton chromé
12008	32,5 x 26,5	15	1/2	vergoldeter Griff / gold plated handle pomo dorado / bouton doré
12010	32,5 x 26,5	15	1/2	verchromter Griff / chrome plated handle pomo cromado / bouton chromé



GN 1/1

GN 1/1 Rolltophaube „SUNDAY“

GN 1/1 rolltop cover
GN 1/1 campana rolltop
GN 1/1 cloche rolltop



Griff ABS verchromt, leichtgängig auf- und zuklappbar
handle chrome plated, easy to open and close
asa material ABS cromado, fácil de abrir y cerrar
poignée matériel ABS chrome, ouverture et fermeture faciles

	cm	↑ cm	GN
11016	53,0 x 32,5	19	1/1



GN 1/1

GN 1/1 Rolltop-Haube

GN 1/1 rolltop cover
GN 1/1 campana abatible
GN 1/1 cloche basculante



verchromter Zinkdruckguss-Griff / chrome plated metal handle / mango cromado de fundición a presión de zinc / poignée en zinc moulé sous pression chromé

	cm	↑ cm	GN
11018	53,0 x 32,5	19	1/1

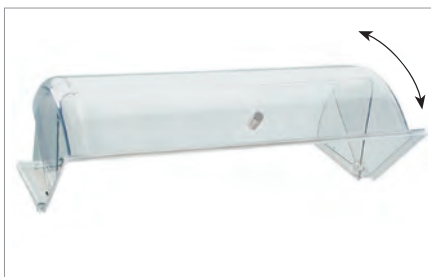

Rolltophaube „FOCUS“

rolltop cover
campana abatible
cloche basculante



verchromter Griff / chrome plated handle / pomo cromado / bouton chromé

	cm	↑ cm
09013	44 x 33,5	17



GN 1/1

GN 1/1 Haube

GN 1/1 cover
GN 1/1 campana
GN 1/1 cloche



klappbar, passend für GN 1/1-Behälter, GN 1/1-Tablets, etc., nahezu bruchfest
suitable for GN 1/1 chafing dish, GN 1/1 trays, GN 1/1 pans
plegable, para cubetas GN 1/1, bandejas GN 1/1 etc., muy resistente a la rotura
pliable, pour bacs GN 1/1, plateaux GN 1/1 etc., très résistant à la casse



klappbar
adjustable

	cm	↑ cm	GN
11013	53,0 x 32,5	6	1/1



Rolltophaube

rolltop cover
campana abatible
cloche basculante

SAN
KUNSTSTOFF



glasklarer Kunststoff, leichtgängig auf- und zuklappen 90°
solid quality, to be opened 90°
plástico transparente, apertura 90°
plastique transparent résistant, ouverture 90°

	Ø cm	↑ cm	
18388	38	20	mit verchromtem Kugelgriff / with chrome plated handle con pomo cromado / avec bouton chromé
18387	38	20	mit vergoldetem Kugelgriff / gold plated handle pomo dorado / bouton doré
18380	50	26	mit verchromtem Zylindergriff / chrome plated handle pomo cromado / bouton chromé



Frischhalte-Haube

cover
campana
cloche bombée

SAN
KUNSTSTOFF



glasklar, Griff verchromt, schwere, stabile Ausführung
transparent, chrome knob, heavy stable quality
transparente, asa cromada, alta estabilidad
transparente, anse chromée, très stable

	Ø cm	↑ cm	fits to
15350	16,5	10	15130
15351	20,5	10	15131, 15141, 15271



SUPER DOME



Frischhalte-Haube „SUPER DOME“

cover
campana
cloche

schwere, glasklare Qualität
stable, crystal clear quality
muy resistente y transparencia cristalina
haute résistance et transparence



	Ø cm	↑ cm
06525	30	40

passende Servier- Tortenplatten / suitable cake stands / porta pasteles compatibles /
présentoirs à gâteaux compatibles

	Ø cm	↑ cm	fits to	Farbe / Colour
85051	30,5	9,0	06525	
85052	30,5	17,0	06525	
00468	31,0	3,5	06525	
85112	32,0	3,5	06525	
33294	33,0	8,0	06525	
33295	33,0	16,0	06525	



Servierbeispiel
presentation example

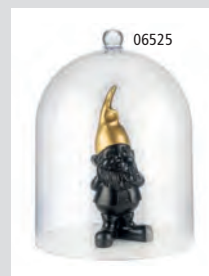

Präsentationsmöglichkeiten
presentation examples





11051 Ø 22 cm



11052 Ø 24 cm



11053 Ø 28 cm



11054 Ø 28,5 cm

Tellerabdeckhaube

plate cover
cubierta para plato
couvertle pour assiette



passend für unterschiedliche Tellergrößen
suitable for different plate sizes
aptas para diferentes tamaños de platos
aptes pour différentes tailles d'assiettes

	Ø cm	↑ cm	passend für unterschiedliche Tellergrößen / suitable for different plate sizes
11051	22,0	7,0	Ø 21,5 cm
11052	24,0	7,5	Ø 22,5 - 23,0 cm
11053	28,0	6,5	Ø 26,0 - 26,5 cm
11054	28,5	6,5	Ø 27,0 - 27,5 cm



Servierbeispiele
presentation example



passende Hauben
suitable covers 11051, 11052

Frischhalte-Haube

cover
campana
cloche



schwere, glasklare Qualität
stable, crystal clear quality
calidad estable y transparencia cristalina
qualité stable et clarté cristalline



Ø 21cm

tray
84942

06520

Ø 30cm

3 sizes available Ø 21 - Ø 30 - Ø 36 cm

	Ø cm	↑ cm	fits to
06519	21	17	84941, 84942
06520	30	22	85034, 84177, 83891, 83890, 83884, 998, 975, 469, 468, 463, 462, 46
06521	36	27	84945, 84946



stapelbar
stackable



06512

Frischhalte-Haube

cover
campana
cloche



glasklar, schwere stabile Ausführung, stapelbar
clear, heavy stable quality, stackable
transparente, alta estabilidad, apilable
transparente, très stable, empilable

	Ø cm	↑ cm	
06512	30	11,5	mit verchromtem Griff / with chrom plated handle con botón cromado / avec bouton chromé
06517	30	11,5	mit verchromtem Griff / with chrom plated handle con botón cromado / avec bouton chromé



06515

Frischhalte-Haube

cover
campana
cloche



glasklar, schwere stabile Ausführung, stapelbar
clear, heavy stable quality, stackable
transparente, alta estabilidad, apilable
transparente, très stable, empilable

	Ø cm	↑ cm	
06510	30	11,5	
06515	33	12,5	



Frischhalte-Haube

cover
campana
cloche



	Ø cm	↑ cm	
06501	30	11	
06504	30	9,5	
06506	30	7	



06501

Frischhaltehauben, 2er Set

covers, 2 pcs. set
campanas, set de 2
cloches, pack de 2



	Ø cm	↑ cm	
40752	30	11	

NEW



Frischhalte- Haube

cover
campana
cloche

	Ø cm	↑ cm	fits to
11055	23	12	00827



Set 00827

glasklar, schwere stabile Ausführung
clear, heavy stable quality

NEW



Frischhalte- Haube

cover
campana
cloche

	cm	↑ cm	fits to
11056	25 x 12	10	00828



Set 00828

glasklar, schwere stabile Ausführung
clear, heavy stable quality

06401



06701

Frischhalte-Haube

cover
campana
cloche

	cm	↑ cm
06401	29,5 x 13,5	10
06701	21,6 x 16,2	7



18621

Lieferung ohne Tablett
delivery without tray

18121

Frischhalte-Haube

cover
campana
cloche

	Ø cm	↑ cm
18621	18	8,5
18121	35,5 x 27,8	7,5



Deckel „FRIDA“

cover
tapa
couvricle



	Ø cm	↑ cm	fits to	€
84962	9	2,5	84930, 84931	
84963	13	2,5	84605, 84606	
84964	16	2,5	84607, 84608	

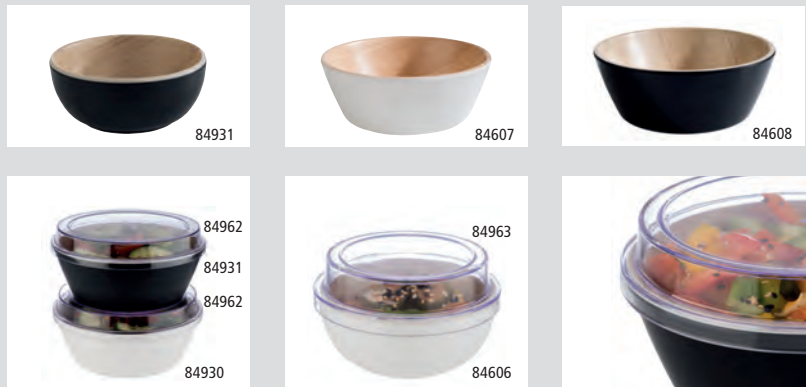

stapelbar / stackable



Deckel „FRIDA“

cover
tapa
couvricle



	cm	↑ cm	fits to	€
84965	13 x 13,0	2,5	84937, 84936	
84966	17 x 17,0	2,5	84558, 84559	
84967	18 x 16,5	2,5	84584, 84583	
84968	18 x 11,0	2,5	84556, 84555	

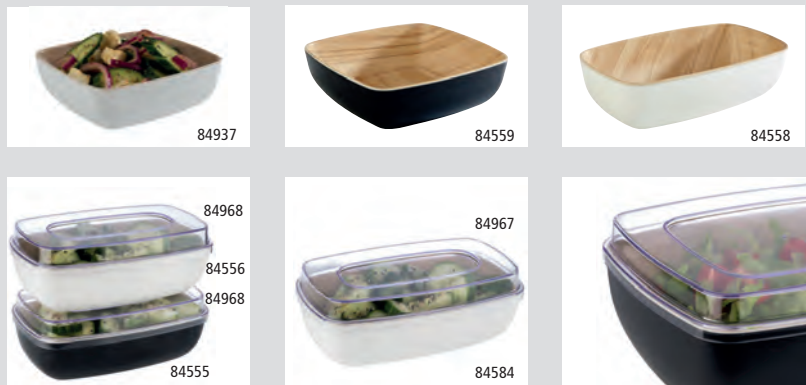

stapelbar / stackable



Deckel „FLOAT“ mit Löffelaussparung
cover, with notched for spoons
tapa, con espacio para la cuchara
couvre-cle, avec encoche pour la louche



	cm	↑ cm	fits to	
83920	Ø 20,5	1,3	83908, 83909	rund
83921	19 x 19	1,3	83916, 83917	eckig
83922	25 x 25	1,3	83918, 83919	eckig



Deckel „PURE“ mit Löffelaussparung
cover with notched for spoons
tapa con espacio para la cuchara
couvre-cle avec encoche pour la louche



	cm	↑ cm	fits to bowls
83600	19 x 19	1,5	84410, 84417, 84422, 83409, 83572, 84468, 83573, 84429, 84244
83601	25 x 25	1,5	84408, 84418, 84423, 83469, 83574, 83575, 83408, 84430, 84245, 84561, 84562
83602	32 x 32	1,5	84425, 84427

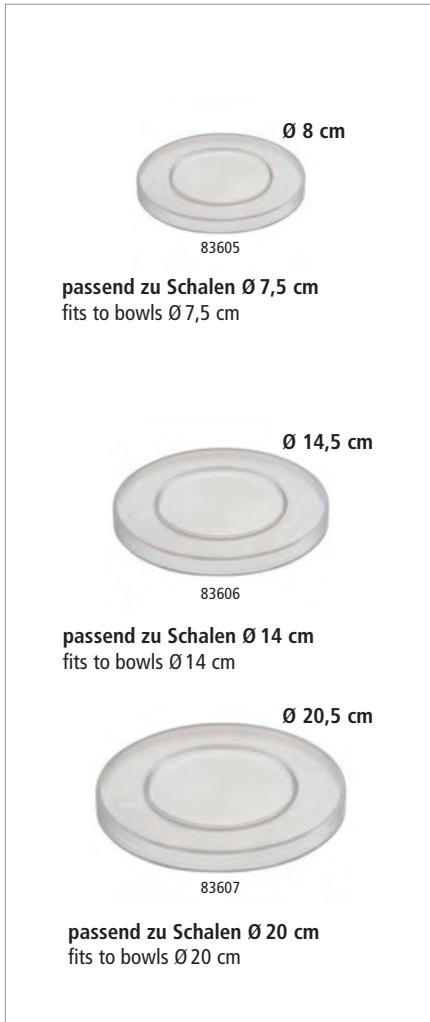

Deckel „CASUAL“, 5er Set
cover, 5 pcs. set
tapa, set de 5
couvre-cle, set de 5



Hygienischer Schutz für Ihre Speisen

- dichtschießend
- schwappsicherer Transport
- BPA-frei

protection for your food

- tightly closing
- slosh-proof transport
- bpa-free

protección de alimentos

- con cierre hermético
- transporte sin salpicaduras
- libre de BPA

protection des aliments

- fermeture hermétique
- transport sans éclaboussures
- sans BPA

	Ø cm	↑ cm	VE	fits to
83605	8,0	0,5	5	11866, 83881, 15400, 15408, 15416, 15461, 15462, 15467, 15468, 40655, 40656
83606	14,5	0,5	5	11865, 83700, 83701, 84990, 85104, 85105, 85107
83607	20,5	0,5	5	83704, 83705, 15105, 15230, 15404, 15412, 15420, 85003, 85005, 85006, 85008

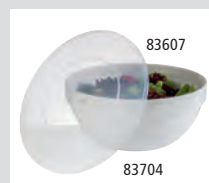

stapelbar
stackable



10890

Frischhaltedeckel

airtight cover
tapa hermética
couvrete hermétique



mit Silikondichtung, für luftdichtes Verschließen, Lebensmittel bleiben lange frisch
with silicone sealing ring, bowls closed airtight, to keep food fresh for a long time
junta de silicona para cerrar herméticamente y mantener los alimentos frescos más tiempo
joint de silicone pour fermeture hermétique et meilleure conservation des aliments

	Ø cm	fits to
10890	14	11865, 83700, 83701
10887	23	11875, 11846, 11848, 83702, 83703



zwei Öffnungspositionen des Deckels
two opening positions of the lid

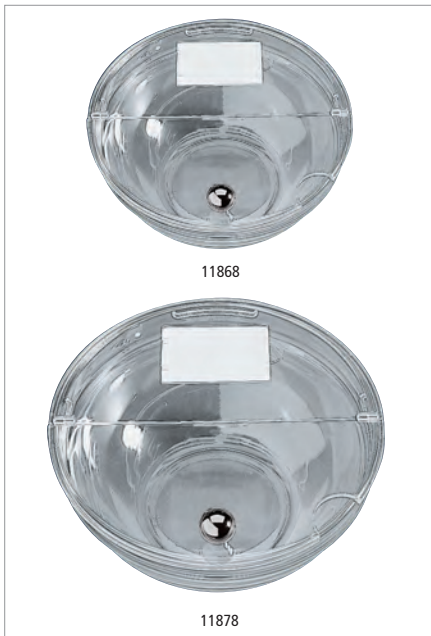

11868

11878

Schutzdeckel mit Löffelaussparung

cover
tapa
couvrete



glasklar, klappbar, mit 10 Beschriftungsschildern
transparent, with 10 cards for inscription
plástico transparente, con 10 etiquetas para inscripción
plastique transparent, avec 10 étiquettes pour inscription

	Ø cm	
11868	14,5	mit verchromtem Griff / chrome plated handle botón cromado / bouton chromé
11878	23,5	mit verchromtem Griff / chrome plated handle botón cromado / bouton chromé

Schilder, 10er Set / signs, 10 pcs. set / set de 10 cartelitos / set de 10 étiquettes

	fits to
12879	11867, 11868
11879	11877, 11878



Deckel klappbar mit Löffelaussparung

cover hinged
tapa con bisagra
couvrete avec charnière



glasklar, mit Designer-Griff, verchromt, ohne Beschriftungsschild
clear, with designer handle, chrome plated, without card for inscription
transparente, con pomo de diseño cromado, sin tarjetas para inscripción
transparent, avec bouton chromé de design, sans étiquette pour inscription

	Ø cm	fits to
10889	23,5	11817, 11818, 11845, 11847, 11849



11875

Schale

bowl
cuenco
bol



	Ø cm	↑ cm	ltr.	pcs
11859	6,0	2,5	0,05	36
11866	7,5	3,5	0,09	36
11865	14,0	6,5	0,50	6
11875	23,0	10,5	2,50	6

**Kühlakku**

cooler
 acumulador de frío
 accumulateur de froid



gefüllt mit Kühlflüssigkeit, nicht giftig, einfach im Gefrierfach einfrieren,
 unbegrenzt wiederverwendbar

freeze it in freezer, non toxic, filled with freezer-liquid, boundless reusable
 se enfría en el congelador, no tóxico, se puede reutilizar sin límite

liquide eutectique qui accumule froid une fois dans le congélateur,
 non toxique, réutilisable sans limites

	Ø cm	↑ cm	Farbe / Colour
10777	15	2,5	
10781	10,5	2,5	
10661	10,5	2,0	
10752	10,5	2,0	

**Kühlakku**

cooler
 acumulador de frío
 accumulateur de froid



gefüllt mit Kühlflüssigkeit, nicht giftig, einfach im Gefrierfach einfrieren,
 unbegrenzt wiederverwendbar

freeze it in freezer, non toxic, filled with freezer-liquid, boundless reusable
 se enfría en el congelador, no tóxico, se puede reutilizar sin límite

liquide eutectique qui accumule froid une fois dans le congélateur, non toxique,
 réutilisable sans limites

	cm	↑ cm	Farbe / Colour
10782	41 x 21	2,5	
10791	25 x 19	2,5	
11101	16 x 7,5	2,0	4er Set / 4 pieces set / set de 4 / set de 4

**Aufsteller „ACHTUNG RUTSCHGEFAHR“**

stand
 letrero
 panneau



	cm	↑ cm	Farbe / Colour
71421	30 x 63	63	



NEW

Trinkflasche



Trinkflasche
drinking bottle
cantimplora
gourde

ÉDELSTAHL
STAINLESS
INOX
18/8

HOLZ
WOOD

die doppelwandige Vakuumflasche aus Edelstahl hält Heißes 12 Stunden heiß und Kaltes 24 Stunden kalt, 100% auslaufsicher

the double-walled stainless steel vacuum bottle keeps hot drinks hot for 12 hours and cold drinks cold for 24 hours, 100% leak proof

la cantimplora al vacío de acero inoxidable de doble pared mantiene las bebidas calientes durante 12 horas y las frías durante 24 horas, 100% transporte sin salpicaduras

la gourde à vide en acier inoxydable à double paroi permet de conserver les boissons chaudes pendant 12 heures et les boissons froides pendant 24 heures, 100% transport sans éclaboussures

	Ø cm	↑ cm	ltr.
66905	7,5	24,5	0,5



Trinkflasche
drinking bottle
cantimplora
gourde

ÉDELSTAHL
STAINLESS
INOX
18/8

HOLZ
WOOD

die doppelwandige Vakuumflasche aus Edelstahl hält Heißes 12 Stunden heiß und Kaltes 24 Stunden kalt, 100% auslaufsicher

the double-walled stainless steel vacuum bottle keeps hot drinks hot for 12 hours and cold drinks cold for 24 hours, 100% leak proof

la cantimplora al vacío de acero inoxidable de doble pared mantiene las bebidas calientes durante 12 horas y las frías durante 24 horas, 100% transporte sin salpicaduras

la gourde à vide en acier inoxydable à double paroi permet de conserver les boissons chaudes pendant 12 heures et les boissons froides pendant 24 heures, 100% transport sans éclaboussures

	Ø cm	↑ cm	ltr.
66906	7,5	29,5	0,75



...immer dabei



mit Schraubverschluss
with screw cap

inkl. Ersatzdichtung
incl. spare gasket

500 ml

750 ml



Lunchbox „M“ lunchbox fiambrella boîte à lunch



Edelstahlbox mit Silikondichtung inkl. Trennsteg, auslaufsicher

stainless steel box with silicone seal incl. divider, leak-proof

caja de acero inoxidable con junta de silicona y divisor extraíble, transporte sin salpicaduras

boîte en acier inox avec joint en silicone et diviseur amovible, transport sans éclaboussures

	cm	↑ cm	litr.
66900	18,5 x 13,5	6,5	0,8



Lunchbox „L“ lunchbox fiambrella boîte à lunch



Edelstahlbox mit Silikondichtung inkl. Trennsteg, auslaufsicher

stainless steel box with silicone seal incl. divider, leak-proof

caja de acero inoxidable con junta de silicona y divisor extraíble, transporte sin salpicaduras

boîte en acier inox avec joint en silicone et diviseur amovible, transport sans éclaboussures

	cm	↑ cm	litr.
66901	20,5 x 14,5	6,5	1,1



Lunchbox „XL“ lunchbox fiambrella boîte à lunch



Edelstahlbox mit Silikondichtung inkl. Trennsteg, auslaufsicher

stainless steel box with silicone seal incl. divider, leak-proof

caja de acero inoxidable con junta de silicona y divisor extraíble, transporte sin salpicaduras

boîte en acier inox avec joint en silicone et diviseur amovible, transport sans éclaboussures

	cm	↑ cm	litr.
66902	22,5 x 16,5	6,5	1,4



mit zwei Verschlüssen
with 2 clasps

66900

0,8 ltr.



66901

1,1 ltr.



66902

1,4 ltr.



herausnehmbarer Trennsteg
removable divider

auslaufsicher | leak-proof

Laserlogo Individual

perfekte Lasergravuren
perfectly Laser engravings
grabado perfecto por láser
marcage laser parfait



Unverwechselbar - Einzigartig - Imagefördernd Ihre individuelle Lasergravur von APS

Wir bieten Ihnen die Möglichkeit, unsere Produkte mit Ihrem individuellen Logo per Laser zu gravieren - einzigartig, unverwechselbar und bereits ab 10 Stück je Artikel. Die perfekte Beschriftung durch modernste Lasertechnologie ist spülmaschinenfest und somit dauerhaft auf allen Edelstahl- und Naturschieferprodukten, sowie auf versilberten und verchromten Metall-Artikeln umsetzbar. Machen Sie aus Ihren Gastronorm-Behältern Ihre ganz persönlichen Unikate und werten Sie Ihre Servierartikel mit Ihrem eigenen Logo auf.

- geringe Mindestbestellmenge von nur 10 Stück
- kurze Lieferzeiten
- Logos bis zu einer Fläche von max. 10 x 10 cm realisierbar

Distinct - Unique - Image enhancing Your individualised laser engraving by APS

We offer you the option of having your personalised logo engraved on our products - inimitable, unique, and available for delivery from only 10 pieces per product. The perfect inscription by use of the newest technology is dishwasher-safe and thus can be permanently applied to products made of stainless steel and natural slate, as well as silver-coated and chromed metal articles. Turn your gastronorm container into your individual, one of a kind article and enhance your serving items with your own logo.

- minimum order quantity of only 10 pieces
- swift delivery
- feasible logos are those with a maximum size of 10 x 10 cm

Único, personalizado, promotor de imagen Grabado laser por APS

Podemos grabar su logo y así personalizar los productos APS a partir de mínimo 10 unidades por referencia.

Gracias a la novedosa tecnología de grabado por láser, la inscripción es perfecta y resistente al lavavajillas. Se puede aplicar a los artículos en acero inoxidable, pizarra natural, metal cromado y plateado.

- Cantidad mínima de solamente 10 unidades
- Realización rápida
- Tamaño de logos hasta máximo 10 x 10 cm

Unique, original, porteur d'image Marcage laser par APS

Nous pouvons graver votre logo et ainsi personnaliser les produits APS à partir de 10 pièces par référence.

Grâce à une technologie d'avant-garde de marcage par laser, l'inscription est parfaitement reproduite et résistante au lave-vaisselle. Ce type de marcage peut s'appliquer sur l'acier inoxydable, sur l'ardoise naturelle, sur le métal chromé ou argenté.

- Quantité minimum de seulement 10 unités
- Fabrication rapide
- Taille du logo jusque 10 x 10 cm

Icon-Index / Material-Index

	neuer Artikel new item		spülmaschinengeeignet dishwasher-proof		für Induktionsplatten for induction use		max. 70°C
	MF - Melamin		nicht spülmaschinengeeignet not dishwasher-proof		kühlbar for cooling		
	Made in Germany		abwaschbar / wasserfest water-proof		bruchsicher shatter-proof		
	GN-Größen GN norm		mikrowellengeeignet microwave-proof		Eigenmontage self assembly		
	stapelbar stackable		nicht mikrowellengeeignet not microwave-proof		für Lebensmittelkontakt food safe		
	Antirutsch-Füßchen non-slip feet		keine direkte Hitze not direct heat		recyclbar recyclable		
	wasserfest water-resistant		nicht für Backofen not for baking oven		BPA frei BPA free		

APS - BSCI-Mitglied

APS engagiert sich für die Verbesserung von Arbeitsbedingungen. Wir sind Partner der europäischen Organisation BSCI. Die "Business Social Compliance Initiative" (BSCI) ist eine Initiative von Unternehmen zur Verbesserung der Arbeitsbedingungen in der globalen Versorgungskette.



APS is a member of BSCI

APS is committed to the improvement of working conditions. We are a partner of the European organization BSCI. The "Business Social Compliance Initiative" is an initiative of enterprises to improve working conditions in the global supply chain.

APS Melamin - Garantierte Qualität

APS-Melaminprodukte entsprechen den Richtlinien (EG) 1935/2004 und (EU) 10/2011 der Europäischen Kommission. Diese enthalten Bestimmungen für Materialien aus Kunststoffen, welche mit Lebensmitteln in Berührung kommen. Wir arbeiten sehr eng mit den Zertifizierungsinstitutionen Intertek und TÜV zusammen und können somit die Lebensmittelsicherheit (LFGB Regulation) der APS-Melaminartikel garantieren.

APS Melamine - Guaranteed quality

APS melamine products comply with directives (EG) 1935/2004 and (EU) 10/2011 of the European Commission. This contain provisions for plastic materials which come into contact with foodstuffs. We work very closely together with the certification institutions Intertek and TÜV and are therefore able to guarantee the compatibility with foodstuffs (German LFGB regulation) of APS melamine.

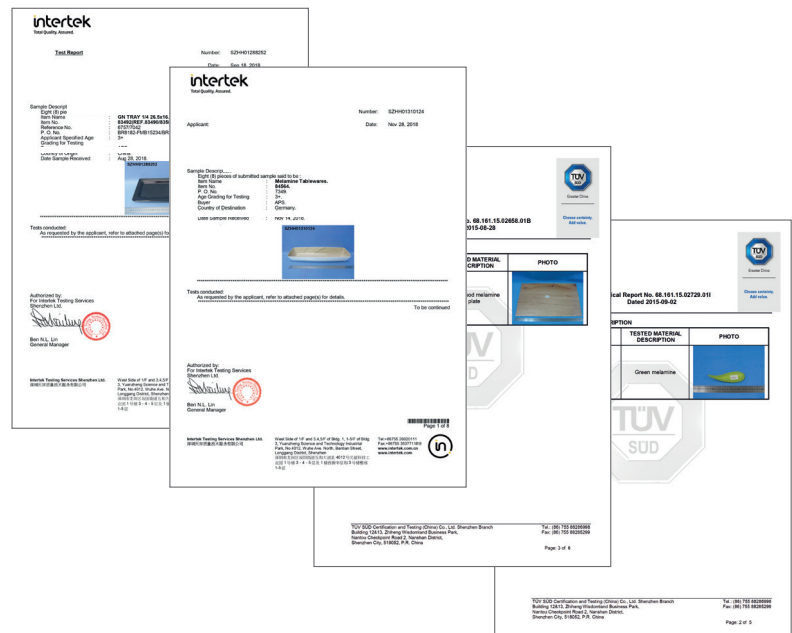

**Edelstahl 18/10 / Stainless steel 18/10**

Werkstoff 1.4301; rostfrei; langlebig; gute isolierende Eigenschaften; absolut hygienisch und nicht toxisch; recyclebar; nicht resistent gegen dauerhaften Kontakt mit Chloriden und Säuren (z. B. Kochsalz und Fruchtsäuren); sterilisierbar; Oberfläche lässt sich vielfältig polieren; nicht magnetisch; Gebrauchstemperatur bis ca. 400 °C

Pflege: pflegeleicht; maschinell oder per Hand mit milden Spülmitteln; möglichst keine Stahlwolle u. ä. verwenden; nach Erhitzung Schockabkühlung vermeiden

**Edelstahl (unspezif.) / Stainless steel (unspecific)**

niedrig nickelhaltige Edelstähle wie 14/4; nicht magnetisch; geringere allgemeine Resistenz als Edelstahl 18/10; Pflege: s. Edelstahl 18/10

**Edelstahl 18/0 / Stainless steel 18/0**

Werkstoff 1.4016; rostfrei; langlebig bei entsprechender Pflege; absolut hygienisch und nicht toxisch; gut härtbar, daher idealer Stahl für Tafelmesser, Tablett, Schneidwerkzeuge u. ä.; lässt sich hochglanzpolieren; für Nickelallergiker geeignet; magnetisch; nicht so chemikalienresistent wie Edelstahl 18/10; Gebrauchstemperatur bis ca. 400 °C

Pflege: maschinell oder per Hand mit milden Spülmitteln; Ablagerungen von Kalk und Reinigerresten nach dem Spülen unbedingt entfernen; niemals mit Stahlwolle reinigen

**Eisen / Iron**

nicht rostfrei; charakteristische, strukturierte Oberfläche mit unterschiedlichen Schattierungen; durch wiederholten Schmiedevorgang ist das Material stark verdichtet und sehr hart; langlebig bei entsprechender Pflege, Pflege: vor erstem Einsatz mit Öl und Kartoffelschalen „einbraten“; später nach jeder Reinigung einfetten; stets trocken lagern

**Gusseisen / Cast Iron**

langlebig bei entsprechender Pflege; geeignet für alle Herdarten (inkl. Induktion); speichert lange Wärme und gibt sie gleichmäßig ab; absolut hygienisch bei unbeschädigter Oberfläche; relativ schweres Material; Überhitzung fast nicht möglich; nicht schlagfest; magnetisch, Pflege: nach Gebrauch sofort mit heißem Wasser reinigen; bei Fleckenbildung mit Essig nachreinigen; niemals mit Stahlwolle reinigen; milde Spülmittel verwenden; stets trocken lagern

**Versilberter Stahl / Silver plated steel**

Edelmetallüberzug; nicht völlig säurefest; nicht über längere Zeit Sonnenlicht aussetzen

Pflege: niemals scheuernde Hilfsmittel verwenden; nur mit weichem Lappen und Spezialmitteln reinigen; keine Spülmaschinenreinigung!

**Verchromter Stahl / Chrome plated steel**

nichtedles Metall mit hartem Chromüberzug; nicht säurefest; nach Beschädigung der Chromschicht kein Schutz gegen Umwelteinflüsse

Pflege: niemals scheuernde Hilfsmittel verwenden; nur mit weichem Lappen

**Aluminium**

sehr leichtes Material; sehr gute elektrische und thermische Leitfähigkeit; korrosionsbeständig; nicht spülmaschinengeeignet; Gebrauchstemperatur bis ca. +500 °C

**Porzellan**

spülmaschinengeeignet; hitzebeständig bis ca. +220 °C

**GFK – Glasfaserverstärkter Kunststoff**

starr; nahezu unzerbrechlich; spülmaschinengeeignet; Gebrauchstemperatur bis ca. +100 °C

**ABS – Acrylnitril-Butadien-Styrol**

sehr gute Oberflächenhärte; temperaturwechselfest; spülmaschinengeeignet; Gebrauchstemperatur bis ca. +100 °C

**ACRYL – künstliches Harz**

farblos; glasartig; durchsichtig; nicht splittend; chemisch modifiziert als Plexiglas®; wichtiger Pflegehinweis: nur handelsübliche Acrylspezialreiniger oder milde alkohol- und ammoniakfreie Reinigungsmittel verwenden; nicht spülmaschinengeeignet; Gebrauchstemperatur ca. -40 °C bis ca. +50 °C

**EVA - Ethylenvinylacetat**

weich elastisch; glänzend; abwaschbar / wasserfest; Gebrauchstemperatur bis ca. +60 °C

**MF - Melamin**

sehr hart; stoß- und kratzfest; hygienisch; säurebeständig; spülmaschinengeeignet; Gebrauchstemp. ca. -30 °C bis +70 °C

**MS - Kunststoff**

farblos; glasartig; durchsichtig; nicht spülmaschinengeeignet; Gebrauchstemperatur ca. 0 °C bis ca. +70 °C

**PA - Polyamid**

starr; bruch- und schlagfest; mattglänzend; spülmaschinengeeignet; Gebrauchstemperatur bis ca. +220 °C

**PC - Polycarbonat**

starr; nahezu unzerbrechlich; sehr stabil; formbeständig in kochendem Wasser; spülmaschinengeeignet; mikrowellengeeignet; Gebrauchstemperatur ca. -30 °C bis ca. +100 °C

**PE - Polyethylen****HDPE – hochdichtes Polyethylen**

hart elastisch; unzerbrechlich; ausreichend formbeständig in heißem Wasser; glänzend; spülmaschinengeeignet; Gebrauchstemperatur ca. -40 °C bis ca. +120 °C

NDPE – niederdichtes Polyethylen

weich elastisch; unzerbrechlich; kurzzeitig formbeständig in heißem Wasser; nicht glänzend; spülmaschinengeeignet; Gebrauchstemperatur ca. -40 °C bis ca. +95 °C

**PP - Polypropylen**

hart elastisch; unzerbrechlich; umweltschonend recyclebar; spülmaschinengeeignet; mikrowellengeeignet; Gebrauchstemperatur ca. -30 °C bis ca. +75 °C

**PS - Polystyrol**

starr; kratzfest; formbeständig in kochendem Wasser; nicht spülmaschinengeeignet; Gebrauchstemperatur bis ca. +70 °C

**PVC - Polyvinylchlorid**

säurebeständig; schwer entflammbar; nicht spülmaschinengeeignet; Gebrauchstemperatur ca. -50 °C bis ca. +60 °C

**SAN - Styrol-Acrylnitril**

gute Oberflächenhärte; temperaturwechselfest; spülmaschinengeeignet; Gebrauchstemperatur bis ca. +100 °C

**Silikon**

hohe thermische Beständigkeit; gute Kälteflexibilität; spülmaschinengeeignet; Gebrauchstemp. ca. -70 °C bis ca. +180 °C

**Tritan®**

starr; unzerbrechlich; absolut formbeständig; sehr hohe Chemikalienbeständigkeit; spülmaschinenfest; Gebrauchstemperatur ca. -30 °C bis ca. +95 °C; nicht mikrowellengeeignet

**Schiefer®**

Naturschiefer versiegelt; lebensmittelecht; nicht spülmaschinengeeignet;

**Beton®**

Werkstoff Beton, coole Optik; nicht spülmaschinengeeignet; handgefertigt

**Tetron**

Maschinenwaschbar bis 30 Grad, 65% Polyester, 35% Viskose

Index

Artikel-Nr.	Prüf-ziffer	Seite	00505	1	144, 468	00650	8	395	00869	4	134, 279	01332	2	116	09104	7	36
00011	7	343	00506	8	143, 467	00652	2	120	00870	0	134, 279	01335	3	116	09200	6	37
00012	4	343	00507	5	143, 467	00662	1	481	00871	7	134, 279	01336	0	115	09202	0	37
00013	1	347	00508	2	144, 468	00664	5	481	00872	4	134, 279	01338	4	116	09204	4	37
00014	8	154, 284, 337	00510	5	143, 467	00666	9	481	00873	1	134, 279	01348	3	116	09923	4	242
00016	2	336	00511	2	143, 467	00668	3	481	00874	8	134, 279	01349	0	116	09924	1	242
00017	9	347	00515	0	143, 467	00670	6	481	00875	5	134, 279	01358	2	116	1		
00018	6	339	00521	1	145, 469	00671	3	482	00876	2	134, 279	01415	2	112	10316	0	303, 460
00019	3	335	00522	8	145, 469	00672	0	482	00877	9	134, 279	01416	9	112	10318	4	462
00020	9	335	00524	2	144, 468	00673	7	482	00878	6	139, 280	01420	6	112	10319	1	462
00021	6	344	00525	9	144, 468	00677	5	268	00879	3	132	01699	6	118, 305	10320	7	462
00022	3	341	00526	6	144, 468	00685	0	490	00880	9	132	01709	2	117	10321	4	462
00023	0	344	00528	0	145, 469	00686	7	490	00881	6	132	01710	8	117	10322	1	461
00024	7	336	00529	7	145, 469	00687	4	490	00882	3	132	01711	5	117	10323	8	461
00025	4	335	00530	3	145, 469	00688	1	490	00883	0	95, 142	01712	2	117	10325	2	461
00026	1	335	00531	0	145, 469	00691	1	268	00884	7	95, 142	01738	2	116	10326	9	461
00027	8	336	00532	7	145, 469	00692	8	268	00885	4	95, 142	01748	1	116	10327	6	461
00028	5	335	00533	4	145, 469	00693	5	268	00886	1	95, 142	02038	2	338	10328	3	461
00029	2	336	00535	8	145, 469	00694	2	511	00887	8	134, 279	02039	9	338	10329	9	461
00030	8	344	00536	5	145, 469	00695	9	511	00897	7	133, 281, 468	02310	9	119	10330	6	461
00031	5	338	00537	2	145, 469	00696	6	511	00898	4	133, 281, 468	02311	6	119	10331	3	461
00032	2	304	00538	9	145, 469	00697	3	511	00899	1	133, 281, 468	02312	3	119	10332	0	461
00033	9	303, 463	00540	2	145, 469	00700	0	345	00905	9	135, 276	03020	6	312	10333	4	460
00036	0	344	00541	9	145, 469	00711	6	482	00906	6	135, 276	03025	1	312	10335	1	460
00037	7	342	00542	6	145, 469	00712	3	482	00907	3	139, 276	03038	1	312	10336	8	460
00040	7	509	00543	3	145, 469	00713	0	482	00908	0	139, 276	03039	8	312	10400	6	40
00042	1	509	00547	1	143, 467	00714	7	482	00910	3	100	03098	5	312	10403	7	39
00046	9	147, 329	00548	8	143, 467	00715	4	482	00911	0	23, 100	03099	2	312	10404	4	39
00048	3	473	00549	5	143, 467	00716	1	482	00912	7	100	03622	2	109, 253	10405	1	39
00050	6	473	00552	5	145, 469	00721	5	482	00914	1	100	03623	9	109, 253	10409	9	39, 452
00052	0	472	00553	2	145, 469	00722	2	482	00937	0	130, 277	03824	0	114	10410	5	39
00054	4	472	00554	9	145, 469	00723	9	482	00941	7	129, 278	04001	4	310	10411	2	39
00056	8	472	00555	6	145, 469	00730	7	482	00942	4	129, 278	04002	1	310	10415	0	41, 452
00058	2	332, 470	00560	0	471	00740	6	503	00945	5	129, 278	04003	8	310	10416	7	41
00060	5	345	00561	7	471	00744	4	503	00951	6	95, 142	04004	5	310	10417	4	41
00063	6	304	00562	4	471	00745	1	503	00952	3	95, 142	04005	2	311	10418	1	41
00064	3	119	00563	1	471	00746	8	503	00953	0	94	04006	9	311	10420	4	42
00065	0	120	00564	8	471	00747	5	503	00954	7	94	04008	3	310	10421	1	42, 44
00067	4	70, 119	00565	5	471	00765	9	302, 458	00955	4	95, 142	04010	6	313	10422	8	42, 43
00069	8	74, 348	00566	2	471	00766	6	301, 458	00956	1	95, 142	04011	3	313	10423	5	42, 44
00070	4	343	00567	9	471	00768	0	301, 302, 458	00957	8	95, 142	04015	1	313	10424	2	42, 43, 44, 45
00071	1	346	00568	6	472	00771	0	506	00958	5	86	04016	8	313	10425	9	44
00072	2	345	00570	9	474	00772	7	292, 505	00959	2	94	04017	5	313	10426	6	43, 45
00075	9	115	00572	3	347	00773	4	291	00960	8	91, 131	04020	5	310	10427	3	44, 45
00076	6	343	00574	7	475	00774	1	291	00966	0	129	04021	2	310	10428	0	43, 45
00078	0	345	00576	1	474	00775	8	291	00968	4	130	04035	9	311	10430	3	43
00079	7	345	00578	5	474	00776	5	291	00969	1	130	04036	6	311	10435	8	45
00081	0	114	00580	8	475	00777	2	291	00971	4	130, 277, 290	04037	3	311	10440	2	50
00082	7	114	00581	5	332, 470	00778	9	291	00972	1	121	04446	3	333	10500	3	426
00084	1	114	00582	2	472	00779	6	292, 505	00973	8	24, 25, 128	06401	0	119, 531	10501	0	42, 43, 44, 45, 426
00085	8	115	00583	9	472	00780	2	510	00975	2	130	06501	7	530	10502	7	426
00087	2	114	00584	6	472	00781	9	291	00978	3	121	06503	1	120	10503	4	426
00090	2	473	00585	3	472	00782	6	291	00984	4	131, 277	06504	8	530	10504	1	426
00091	9	473	00586	0	474	00783	3	291	00986	8	129, 277	06506	2	530	10505	8	41, 427
00092	6	507	00587	7	484	00785	7	505	00987	5	129, 277	06510	9	120, 135, 253, 530	10506	5	268
00093	3	507	00588	4	484	00805	2	140	00988	2	129, 278	06512	3	77, 135, 140, 253, 530	10509	6	427
00094	0	507	00589	1	484	00806	9	95, 132, 140, 142	00989	9	91, 131	06515	4	530	10510	2	427
00098	8	507	00590	7	484	00807	6	140	00990	5	24, 25, 128	06517	8	530	10511	9	427
00099	5	507	00591	4	484	00808	3	135, 276	00991	2	24, 25, 128	06519	2	140, 148, 204, 213, 328, 529	10512	6	427
00106	0	509	00592	1	485	00809	0	137	00992	9	128	06520	8	77, 135, 140, 148, 204, 213, 328, 529	10513	3	426
00110	7	507	00593	8	485	00810	6	133, 281	00993	6	24, 25, 128	06521	5	140, 148, 204, 213, 328, 529	10514	0	426
00113	8	507	00594	5	485	00811	3	133, 281	00994	3	128, 278	06525	3	149, 528	10515	7	426
00292	0	336	00595	2	485	00812	0	133, 281	00995	0	128, 278	06701	1	119, 531	10516	4	426
00311	8	338	00596	9	485	00813	7	133, 281	00996	7	128, 278	08201	4	115	10517	1	426
00381	1	114	00597	6	485	00814	4	133, 281, 468	00997	4	131	09000	2	35	10525	6	427
00382	8	114	00598	3	485	00815	1	140	00998	1	130	09001	9	35	10526	3	427
00383	5	114	00599	0	495	00816	8	140	00999	8	130	09002	6	35	10527	0	427
00384	2	114	00600	3	478	00817	5	137	01000	0	121, 130, 138	09003	3	35	10528	7	427
00385	9	114	00601	0	479	00818	2	135, 147, 330	01								

10576	8	428	10865	3	49	11444	9	104	11762	4	156	11998	7	152, 335	14985	4	21
10577	5	428	10867	7	49	11446	3	104	11763	1	156	11999	4	153, 335, 411	14987	8	21, 66
10578	2	428	10870	7	20, 51	11449	4	104	11765	5	156	12000	0	110	14990	8	18
10579	9	428	10871	4	20, 51	11451	7	105	11767	9	155	12008	2	526	14995	3	21
10608	6	47	10872	1	20, 51	11455	5	105	11768	6	155	12010	5	526	15100	0	167
10661	1	19, 32, 33, 535	10873	8	20, 51	11456	2	105	11770	9	155	12065	5	111	15101	7	167
10663	5	51	10887	5	19, 534	11466	1	105	11771	6	155	12100	0	110	15102	4	167
10668	0	67	10889	9	534	11467	8	105	11775	4	93	12225	3	389	15105	5	168
10690	1	56	10890	5	19, 534	11495	1	80, 83	11776	1	93	12232	1	390	15106	2	168
10691	8	56	10907	0	52	11496	8	80	11778	5	157	12233	8	386	15108	6	168
10700	7	46	10910	0	55	11497	5	80	11780	8	157	12235	2	389	15110	9	167
10701	4	47	10911	7	55	11498	2	80	11781	5	157	12236	9	386	15111	6	167
10703	8	47	10912	4	55	11499	9	80	11795	2	81	12243	7	392	15112	3	167
10704	5	47	10913	1	54	11503	3	30	11805	8	65	12244	4	392	15113	0	167
10707	6	47	10914	8	54	11505	7	30	11807	2	65	12245	1	386	15114	7	167
10708	3	47	10915	5	54	11510	1	28	11808	9	64, 65	12249	9	385, 386	15115	4	167
10709	0	47	10916	2	54	11512	5	29	11810	2	33	12270	3	78, 387	15116	1	166
10710	6	47	10917	9	54	11514	9	28	11811	9	32, 33	12271	0	78, 387	15117	8	166
10711	3	47	10921	6	55	11516	3	29	11812	6	32	12272	7	78, 387	15200	7	169
10712	0	47	10922	3	55	11522	4	84	11813	3	32	12285	7	393	15201	4	169
10713	7	47	10923	0	55	11523	1	83, 84	11815	7	33	12287	1	53, 392, 393	15204	5	169
10714	4	47	10924	7	55	11524	8	83	11816	4	32, 33	12290	1	394	15205	2	169
10715	1	47	10990	2	63, 461	11526	2	83	11817	1	32	12291	8	383, 384, 393	15215	1	169
10716	8	47	10991	9	63, 461	11527	9	83	11818	8	32	12292	5	394	15216	8	169
10717	5	47	10992	6	63, 461	11528	6	84	11833	1	66	12294	9	394	15217	5	169
10718	2	39, 41	10993	3	63	11529	3	84	11834	8	66	12295	6	78, 379, 380, 382, 383, 384, 387, 393	15218	2	169
10720	5	46	10994	0	63	11533	0	31	11840	9	64	12296	3	382, 393	15219	9	168
10721	2	56	11000	0	110	11538	5	31	11841	6	64	12297	3	382, 393	15220	5	168
10722	9	56	11008	3	26, 30, 363, 526	11540	8	26	11845	4	34	12299	4	393	15225	0	166
10738	0	57	11010	6	26, 28, 30, 195, 211, 363, 526	11541	5	26	11846	1	32, 33	12300	7	385	15226	7	166
10739	7	57	11011	7	526	11542	2	27	11847	8	33	12310	6	392	15227	4	166
10741	0	57	11013	7	526	11543	9	27	11848	5	32, 33	12312	9	378	15228	1	166
10742	7	57	11016	8	526	11553	8	364	11849	2	33	12322	9	378	15230	4	169
10748	9	58	11018	2	17, 363, 526	11555	2	364	11859	1	534	12323	6	378	15231	1	169
10749	6	58	11020	5	111	11556	9	102	11865	2	80, 534	12324	3	379	15232	8	169
10750	2	51	11021	2	195, 211, 363, 525	11557	6	86, 141	11866	9	534	12325	0	379	15233	5	169
10752	6	58, 535	11022	9	363, 371, 525	11558	3	86, 141	11868	3	32, 33, 80, 534	12329	8	388	15234	2	168
10756	4	52	11026	7	363, 525	11562	0	102	11875	1	34, 79, 534	12330	4	388	15235	9	168
10757	1	52	11027	4	195, 352, 362, 363, 371, 525	11563	7	93	11878	2	32, 33, 34, 79, 534	12335	9	388	15320	2	176, 374
10758	8	52	11028	1	363, 525	11572	9	102	11879	9	347, 534	12336	6	388	15321	9	374
10759	5	52	11032	0	110	11573	6	102	11881	2	515	12337	3	388	15322	6	176, 374
10760	1	46	11038	0	110	11574	3	93	11884	3	70	12338	0	388	15323	3	374
10761	8	58	11040	0	111	11575	0	93	11888	3	70	12350	2	385	15324	0	176, 374
10762	5	58	11041	0	113, 191, 195, 524	11576	7	93	11885	0	70	12352	6	381	15325	7	374
10764	9	59	11042	7	113, 191, 211, 352, 371, 524	11579	8	462	11887	4	101	12353	3	381	15326	4	375
10766	3	59	11043	4	113, 191, 524	11590	3	30	11888	1	101	12354	0	381	15331	8	375
10769	4	59	11044	1	77, 113, 191, 371, 524	11595	8	79, 84	11889	8	101	12360	1	389	15332	5	375
10770	0	59	11048	0	110	11596	5	79	11891	1	101	12366	3	381, 384	15334	9	375
10771	7	60	11051	9	529	11597	2	79	11892	8	81	12370	0	381	15335	6	375
10772	4	60	11052	6	529	11598	9	79	11893	5	81	12371	7	381	15340	0	168, 171
10773	1	60	11053	3	529	11599	6	79	11901	7	390	12372	4	381	15341	7	168, 169, 171
10774	8	60	11054	0	529	11607	8	102	11910	9	390	12393	9	384	15342	4	168, 171
10775	5	60	11055	7	531	11608	5	153, 306	11911	6	390	12394	6	382	15343	1	171
10776	2	60	11056	4	531	11609	2	153, 306	11912	3	390	12396	0	383	15344	8	168, 169, 171
10777	9	19, 32, 33, 34, 47, 535	11057	0	111	11610	8	153, 306	11913	0	390	12397	7	381, 383	15345	5	167, 169
10778	6	67	11058	3	529	11612	2	307	11915	4	389	12398	4	383	15346	2	167, 169
10781	6	535	11059	0	529	11616	0	24	11916	1	389	12399	1	383	15347	9	167, 169
10782	3	535	11060	0	529	11617	7	24	11917	8	389	12403	5	384	15348	6	166, 168
10788	5	46	11061	7	531	11620	7	22, 23	11921	5	337	12404	2	382	15350	9	527
10789	2	46	11062	4	531	11621	4	22, 23	11922	2	337	12483	7	385	15351	6	527
10791	5	26, 27, 28, 30, 31, 35	11065	0	111	11622	1	22	11930	7	334	12484	4	385	15400	1	171
10792	2	56	11100	0	30, 110	11623	8	22	11931	4	334	12879	8	347, 534	15401	8	171
10795	3	53	11101	1	29, 31, 36, 37, 535	11625	2	309	11935	2	339	12940	5	14	15402	5	171
10796	0	53	11110	3	110	11626	9	22, 23	11936	9	339	12941	2	14	15403	2	171
10800	4	46	11118	9	15	11627	6	22, 23	11937	6	339	12990	0	448	15404	9	171
10801	1	47	11119	6	15, 234	11628	3	22	11939	0	152, 339	13122	4	117	15405	6	171
10802	8	48	11150	9	111	11629	0	22	11940	6	412	13377	8	509	15406	3	171
10803	5	47	11155	4	111	11638	2	154, 307	11945	1	409	13378	5	509	15407	0	171
10804	2	47	11160	8	112	11647	4	307	11946	8	409	13379	2	509	15408	7	171
10805	9	49	11165	3	112	11648	1	307	11947	5	409	13380	8	126, 282	15409	4	171
10806	6	49	11166	0	112	11649	8	154, 308	11948	2	150	13382	2	117	15410	0	171
10807	3	47	11195	0	113, 405	11650	4	309	11949	9	150	13385	3	117	15411	7	171
10808	0	47	11210	0	112	11651	1	309	11950	5	412	13622	9	117	15412	4	171
10809	7	47	11220	9	112	11671	9	53, 392	11951	2	150	13940	4	14	15413	1	171
10810	3	53	11244	5	392	11672	6	53, 392	11952	9	150	13941	1	14	15414	8	171
10812	7	47	11290	2	111	11675	7	386	11954	3	151, 410	13955	8	15	15415	5	171
10814	1	47	11295	7	112	11683	2	394	11955	0	151, 410	13960	2	15	15416	2	171
10825	7	52	11300	8	111	11700	6	25	11960	4	151, 410	13965	7	66	15417	9	171
10830	1	51	11302	2	113, 407	11701	3	25	11965	9	151, 410	13966	4	73	15418	6	171
10833	2	51	11305	3	113, 524	11702	0	25	11966	6	151, 35						

15440	7	170	30065	1	413, 512	30422	2	372	36038	9	422	40222	5	360	40499	1	301, 458
15443	8	170	30066	8	413, 512	30423	9	372	36044	0	421	40223	2	359	40500	4	292
15444	5	170	30067	5	413, 512	30440	6	367	36045	7	420	40224	9	360	40501	1	292
15445	2	170	30068	2	413, 512	30441	3	367	36046	4	420	40225	6	359	40503	5	292
15448	3	170	30069	9	413, 512	30442	0	367	36047	1	420	40226	3	360	40504	2	136, 292
15449	0	170	30070	5	413, 512	30443	7	367	36048	8	422	40227	0	359	40505	9	292
15450	6	170	30071	2	413, 512	30444	4	367	36050	1	424	40228	7	360	40506	6	302, 459
15451	3	170	30075	0	413, 511	30445	1	367	36052	5	422, 424	40229	4	359	40507	3	292
15452	0	170	30076	7	413, 511	30446	8	367	36053	2	422	40230	0	360	40508	0	303, 460
15453	7	170	30077	4	413, 511	30447	5	367	36054	9	422	40240	9	360	40509	7	302, 459
15454	4	170	30078	1	413, 511	30450	5	367	36055	6	417	40242	3	360	40510	3	301, 363, 460
15455	1	170	30108	5	333, 470	30451	2	367	36056	3	422	40243	0	359	40511	0	300
15456	8	170	30110	8	333, 470	33206	5	73	36057	0	421	40244	7	360	40520	2	289
15457	5	170	30111	5	124, 466	33207	2	73	36062	4	424	40245	4	359	40521	9	289
15458	2	170	30112	2	124, 466	33208	9	89	36063	1	423	40246	1	360	40522	6	289
15460	5	170	30113	9	124, 466	33209	6	89	36066	2	417	40247	8	359	40524	0	289
15461	2	174	30114	6	125, 465	33210	2	86	36068	6	418	40248	5	360	40530	1	289
15462	9	174	30115	3	124, 466	33211	9	90	36069	3	418	40249	2	359	40531	8	289
15467	4	174	30116	0	124, 466	33212	6	90	36074	7	423	40250	8	360	40532	5	289
15468	1	174	30117	7	124, 466	33214	0	91	36075	4	425	40260	7	360	40534	9	289
15473	5	174	30118	4	125, 465	33215	7	90	36077	8	421	40262	1	360	40535	6	288
15474	2	174	30119	1	125, 465	33216	4	91	36087	7	421	40263	8	360	40536	3	289
15475	9	174	30120	7	125, 465	33217	1	91	36090	7	424	40264	5	360	40537	0	288
15477	3	174	30121	4	125, 243	33219	5	90	36092	1	416	40266	9	360	40538	7	287
15479	7	174	30123	8	124, 466	33220	1	90	36093	8	416	40268	3	360	40539	4	287
15483	4	174	30126	9	125, 466	33222	5	85	36095	2	61, 419	40270	6	360	40540	0	288
15485	8	174	30130	6	126, 282, 464	33225	6	90	36096	9	61, 419	40272	0	360	40541	7	288
15486	5	174	30131	3	126, 282, 464	33226	3	85	36099	0	424	40274	4	360	40544	8	290
15487	2	174	30132	0	126, 282, 464	33227	0	85	36100	3	61, 420	40276	8	360	40545	5	290
15491	9	174	30133	7	126, 282, 464	33228	7	85	36101	0	61, 420	40278	2	360	40546	2	288
15495	7	174	30148	1	124, 465, 470	33231	7	92	36102	7	456	40280	5	360	40547	9	289
15497	1	170	30149	8	124, 465, 470	33232	4	72, 102	36103	4	456	40290	4	16, 359	40548	6	288
15498	8	170	30200	6	372	33238	6	92	36111	9	61, 419	40291	1	16, 359	40549	3	285
15499	5	170	30205	1	369	33241	6	86	36112	6	61, 419	40292	8	16, 359	40550	9	285
15500	8	170	30206	8	369	33246	1	82, 326	36120	1	419	40293	5	16, 359	40551	6	285
15501	5	176	30207	5	373	33247	8	82, 326	36121	8	419	40294	2	16, 363	40552	3	285
15502	2	176	30208	2	373	33248	5	92	36233	8	332	40295	9	16, 362	40553	0	286
15503	9	100, 176	30210	5	372	33249	2	107	36323	6	332	40296	6	355	40554	7	286
15504	6	176, 206	30220	4	372	33250	8	107	38202	2	115	40297	3	355	40555	4	136, 286
15505	3	176, 206	30230	3	372	33251	5	107				40299	7	363	40556	1	136, 286
15506	0	78, 100, 176, 387	30240	2	372	33252	2	107	4			40300	0	299	40557	8	287
15507	7	176, 375	30250	1	372	33255	3	76, 109	40007	8	334, 365	40310	9	295	40558	5	287
15508	4	176, 375	30270	9	372	33256	0	76, 109	40009	2	334, 365	40311	6	295	40559	2	288
15509	1	176, 375	30276	1	374	33260	7	107	40010	8	334, 365	40312	3	295	40560	8	288
15513	8	109, 176	30277	8	374	33261	4	107	40011	5	334, 365	40313	0	295	40600	1	271
15514	5	109, 176	30279	2	366	33262	1	107	40012	2	334, 365	40320	8	295	40601	8	271
15515	5	167	30280	8	366	33269	0	107	40013	9	334, 365	40330	7	298	40602	5	271
15600	5	167	30281	5	366	33270	6	107	40110	5	114, 374	40331	4	298	40603	2	271
15601	2	167	30282	2	366	33271	3	107	40115	0	114, 374	40403	8	308	40604	9	274, 370
15603	6	167	30283	9	366	33272	0	108	40129	7	362	40404	5	308	40605	6	272
15604	3	167	30284	6	366	33273	7	108	40130	3	334, 365	40405	2	308	40606	3	272
15605	0	167	30285	3	366	33278	2	108	40131	0	334, 365	40410	6	294	40607	0	272
15620	3	77	30286	0	366	33279	9	108	40132	7	361	40411	3	294	40610	0	271
15621	0	77	30287	7	366	33280	5	109	40135	8	361	40412	0	294	40611	7	271
15622	7	77	30288	4	366	33281	2	109	40137	2	361	40413	7	294	40612	4	271
15623	4	77	30299	0	363	33285	0	72	40139	6	361	40414	4	300	40613	1	271
15921	1	304	30310	2	373	33286	7	72	40140	2	361	40415	1	295	40616	2	272
15925	9	304	30325	6	92	33288	1	103	40144	0	72, 102, 361	40424	3	298	40617	9	272
15926	6	304	30332	4	418	33290	4	148, 328	40148	8	361	40425	0	346	40618	6	272
17910	3	15	30333	1	425	33291	1	148, 328	40149	5	362	40435	9	293	40620	9	271
17922	6	15	30334	8	73, 87	33292	8	148, 328	40150	1	363	40436	6	293	40621	6	271
18121	2	531	30335	5	89	33293	5	148, 328	40152	5	361	40437	3	293	40622	3	271
18380	3	141, 527	30336	2	88	33294	2	148, 149, 328, 528	40153	2	362	40438	0	293	40623	0	271
18387	2	27, 362, 527	30337	9	88, 371	33295	9	148, 149, 528	40159	4	361	40439	7	293	40630	8	272
18388	9	27, 29, 31, 253, 362, 527	30338	6	88	33296	6	148, 328	40179	2	364	40440	3	295	40631	5	272
18389	6	16, 362	30339	3	87	33297	3	148, 328	40182	2	364	40441	0	295	40632	2	320
18394	0	121	30340	9	369	34248	4	92, 233	40185	3	273	40442	7	293	40633	9	320
18621	7	531	30341	6	369	35050	2	394	40186	0	118, 273	40445	8	299	40634	6	320
2			30345	4	368	35065	6	394	40187	7	118, 273	40446	5	299	40635	3	320
23642	4	119	30346	1	368	35343	5	394	40188	4	118, 273	40450	2	295	40636	0	320
3			30347	8	368	35350	3	305	40189	1	373	40453	3	298	40637	7	320
30000	2	76	30348	5	368	35711	2	333	40190	7	373	40454	0	298	40638	4	320
30001	9	76	30350	8	369	35720	4	332	40191	4	361	40455	7	296	40640	7	272
30002	6	76	30351	5	369	35730	3	332	40192	1	361	40457	1	296	40642	1	268
30020	0	76	30355	3	308, 368	35734	1	332	40193	8	361	40458	8	296	40643	8	268
30021	7	76	30356	0	136, 308, 368	35735	8	332	40194	5	361	40460	1	296	40644	5	268
30045	3	507	30357	7	373	35912	3	333	40195	2	361	40461	8	296, 297	40645	2	320
30046	0	508	30358	4	373	36003	7	416	40196	9	361	40462	5	296, 297	40646	9	320
30047	7	508	30360	7	369	36004	4	416	40198	3	364	40463	2	296	40647	6	320
30048	4	508	30361	4	369	36010	5	437									

40668	1	304, 319	50702	9	354	60541	1	317	74207	9	115	81391	5	400	82117	0	403
40669	8	319	50703	6	354	60542	8	316	74402	8	505	81395	3	400	82118	7	403
40670	4	132, 136, 282, 284	50705	0	354	60550	3	318	74404	2	505	81400	4	398	82119	4	403
40671	1	132, 136, 282, 284	50706	7	354	60551	0	318	74700	5	503	81401	1	398	82120	0	403
40672	8	132, 136, 282, 284	50707	4	354	60552	7	318	74701	2	503	81402	8	398	82122	4	403
40673	5	132, 136, 282, 284	50708	1	354	60554	1	318	74702	9	503	81404	2	398	82123	1	403
40674	2	132, 136, 282, 284	50710	4	353	61190	0	115	74703	6	503	81406	6	398	82128	6	403
40675	9	269, 283	50711	1	353	61280	8	115	74705	0	503	81408	0	398	82129	3	403
40676	6	269, 283	50712	8	353	61400	0	115	74706	7	503	81492	9	400	82130	9	403
40677	3	132, 136, 284	50713	5	353	65060	2	305, 349, 391, 436	74707	4	504	81495	0	400	82132	3	403
40678	0	132, 136, 284	50714	2	353	65061	9	349, 391	74708	1	504	81502	5	398	82134	7	403
40679	7	132, 136, 284	50720	3	354	65062	6	349, 391	74721	0	503	81504	9	398	82136	1	403, 404
40680	3	269, 464	50722	0	354	65070	1	435	74731	9	506	81506	3	398	82137	8	403
40681	0	269, 464	50727	7	354	65071	8	435	74750	0	463	81591	9	400	82138	5	403
40685	8	139, 273, 280	50723	4	354	65072	5	436	75001	2	305	81595	7	400	82140	8	403
40686	5	139, 273, 280	50800	2	357	66900	0	537	75002	9	305	81602	2	398	82142	2	403
40690	2	274, 370	50801	9	357	66901	7	537	75009	7	492	81604	6	398	82150	7	403
40691	9	274, 370	50802	6	357	66902	4	537	75600	7	492	81606	0	398	82151	4	403
40692	6	274, 370	50803	3	357	66904	8	513	75800	1	491	81608	4	398	82159	0	403
40693	3	274, 370	50805	7	357	66905	5	536	75801	8	487	81692	3	400	82200	9	405
40694	0	274, 370	50806	4	357	66906	2	536	75803	2	492	81695	4	400	82201	6	127, 405
40695	7	274, 370	50807	1	357	7			75804	9	492	81700	5	398	82202	3	127, 405
40700	8	266	50808	8	357	71001	6	492, 515	75805	6	449	81701	2	398	82203	0	127, 405
40701	5	266	50815	6	357	71002	3	492, 515	75806	3	491	81702	9	398	82204	7	127, 405
40702	2	266	50816	3	357	71003	0	492, 515	75807	0	491	81704	3	398	82205	4	127, 405
40703	9	266	50817	0	357	71004	7	492, 515	75808	7	489	81707	7	398	82210	8	379, 384
40704	6	266	50818	7	357	71005	4	492, 515	75809	4	489	81707	4	398	82215	3	379, 384
40705	3	266	50823	1	357	71006	1	492, 515	75810	0	488	81791	3	400	82239	9	70, 324
40706	0	267	50900	9	353	71006	1	492, 515	75820	9	449, 489	81795	1	400	82240	5	70, 324
40707	7	267	50901	6	353	71007	2	466	75821	6	449, 489	81796	8	404	82241	2	324
40708	4	267	50902	3	353	71400	7	466	75822	3	488	81800	2	398	82242	9	324
40709	1	267	50905	4	353	71421	2	521, 535	75823	0	488	81801	9	398	82243	6	70, 325
40710	7	267	50906	1	353	71425	0	348	75824	7	488	81802	6	398	82244	3	70, 325
40711	4	267	50907	8	353	71426	7	348	75825	4	487	81804	0	398	82250	4	69
40712	1	267	50908	5	353	71427	4	348	75830	8	487	81806	4	398	82251	1	69
40713	8	267	50909	8	353	71428	1	348	75831	5	487	81850	7	399	82252	8	69
40752	7	530	50910	8	353	71430	4	463	75832	2	487	81891	0	400	82253	5	69
5			50911	5	353	71431	1	445, 513	75840	7	486	81895	8	400	82255	9	68
50002	0	141	50912	2	353	71433	5	466	75841	4	486	81901	6	399	82256	6	68
50100	3	356	50913	9	353	71440	3	408	75842	1	486	81902	3	399	82257	3	68
50105	8	356	50915	3	354	71441	0	409	75843	8	486	81903	0	399	82265	8	68
50110	2	356	50916	0	354	71460	1	343	75844	5	486	81904	7	399	82266	5	68
50205	5	356	50917	7	354	71461	8	343	75900	8	483	81905	4	399	82267	2	68
50210	9	356	50918	4	354	71462	5	343	75902	2	483	81906	1	399	82300	6	405
50215	4	356	6			71470	0	347	75903	9	483	81907	8	399	82301	3	405
50300	7	356	60002	7	316	71471	7	347	75904	6	483	81908	5	399	82306	8	405
50305	2	356	60012	6	316	71472	4	347	75906	0	483	81909	2	399	82307	5	321
50310	6	356	60014	0	316	71474	8	347	75907	7	483	81910	8	399	82308	2	321
50315	1	356	60015	7	316	71480	9	347	75908	4	483	81911	5	399	82309	9	321
50400	4	356	60016	4	316	71482	3	347	75912	1	483	81996	2	401	82310	5	82, 326
50500	1	355	60018	8	316	71483	0	347	77315	8	463, 502	81997	9	401	82312	9	82, 139, 280, 326
50501	8	355	60019	5	316	71487	8	346	77338	7	506	81998	6	401	82314	3	82, 326
50510	0	355	60020	1	318	71489	2	346	77350	9	513	81999	3	401	82316	7	280, 322
50600	8	357	60022	5	318	71490	8	348	77352	3	513	82001	2	402, 406	82318	1	327
50601	5	357	60023	2	318	71491	5	348	79553	2	86, 141	82003	6	402	82319	8	327
50602	2	357	60024	9	318	71492	2	344	8			82004	3	402	82328	0	66, 69
50603	9	357	60037	9	314	71493	9	344	80023	6	401	82006	7	402	82338	9	327
50605	3	357	60038	6	314	71494	6	344	80024	3	401	82007	4	402	82345	7	322
50606	0	357	60040	9	314	71495	3	346	80025	0	401	82008	1	402	82346	4	322
50607	7	357	60041	6	316	71496	0	341	80026	7	401	82010	4	402, 403	82347	1	322
50608	4	357	60042	3	316	71497	7	341	80027	4	401	82012	8	402	82350	1	323
50610	7	357	60044	7	315	71498	4	346	80028	1	401	82013	5	402, 406	82351	8	323
50611	4	357	60045	4	315	71499	1	346	80029	8	401	82014	2	402	82352	5	323
50612	1	357	60046	1	315	71511	0	342	81000	6	398	82016	6	402	82354	9	323
50613	8	357	60270	0	115	71512	7	342	81095	2	398	82017	3	402	82355	6	15, 127, 405
50620	6	358	60310	3	115	71513	4	342	81100	3	398	82018	0	402	82356	3	127, 405
50621	3	358	60502	2	314	71514	1	342	81101	0	398	82019	7	402, 406	82357	0	15, 127, 405
50622	0	358	60503	9	314	71515	8	342	81102	7	398	82020	3	402	82359	4	322
50623	7	358	60505	3	314	71516	5	342	81104	1	398	82022	7	402	82360	0	325
50624	4	358	60506	0	317	71517	2	342	81106	5	398	82023	4	402	82361	7	325
50625	1	358	60507	7	317	71518	9	342	81108	9	398	82028	9	402	82362	4	325
50626	8	358	60508	4	317	71520	2	341	81109	6	398	82029	6	402, 406	82370	9	322
50627	5	358	60509	1	316	71521	9	340	81116	4	398	82030	2	402	82371	6	322
50628	2	358	60510	7	317	71522	6	340	81117	1	401	82032	6	402	82394	5	327
50629	9	358	60511	4	317	71523	3	340	81118	8	401	82034	0	402	82395	2	327
50630	5	358	60512	1	316	71527	1	340	81191	1	400	82036	4	402	82419	5	412, 511
50631	2	358	60520	6	316	71528	8	340	81195	9	400	82037	1	402, 406	82420	1	412
50632	9	358	60521	3	316	71529	5	340	81198	0	404	82038	8	402	82440	9	412, 521
50633	6	358	60522	0	316	71700	8	518	81199	7	404	82040	1	402	82441	6	412, 521
50634	3	358	60523	7	316	71701	5	518	81200	0	398	82042	5	402	83309	8	75
50635	0	358	60524														

83411	8	243	83654	9	230	83867	3	75	84080	5	244	84260	1	227	84490	2	246
83412	5	243	83655	6	230	83868	0	75	84082	9	244	84261	8	227	84491	9	246
83414	9	240, 243	83696	9	34, 248	83869	7	253	84083	6	244	84262	5	198	84492	6	246
83415	6	240	83697	6	34, 248	83875	8	245	84085	0	244	84263	2	198	84493	3	246
83417	0	239	83698	3	34, 248	83876	5	245	84086	7	244	84264	9	198	84494	0	246
83418	7	239	83699	0	34, 248	83877	2	245	84088	1	244	84265	6	198	84509	1	189
83419	4	240	83700	3	19, 34, 248	83878	9	234	84100	0	217	84266	3	196	84510	7	189
83424	8	258	83701	0	19, 34, 248	83879	6	234	84101	7	217	84267	0	196	84511	4	189
83426	2	258	83702	7	19, 34, 248	83880	2	248	84103	1	217	84268	7	196	84512	1	189
83433	0	238	83703	4	19, 34, 248	83881	9	248	84104	8	217	84269	4	196	84514	5	189
83434	7	238	83704	1	34, 248	83882	6	238	84105	5	217	84295	3	250	84515	2	189
83435	4	244	83705	8	34, 248	83884	0	239	84106	2	217	84300	4	406	84517	6	189
83437	8	244	83712	6	222	83886	4	239	84107	9	218	84301	1	406	84519	0	191
83438	5	244	83714	0	223	83887	1	258	84108	6	218	84302	8	406	84520	6	191
83440	8	244	83716	4	223	83888	8	258	84109	3	218	84303	5	406	84521	3	191
83441	5	244	83718	8	224	83889	5	258	84110	9	219	84304	2	406	84522	0	191
83443	9	244	83720	1	224	83890	1	146, 252, 329	84111	6	219	84305	9	406	84523	7	190
83446	0	245	83721	8	223	83891	8	146, 252, 329	84112	3	219	84306	6	406	84524	4	190
83450	7	240	83722	5	224	83892	5	146, 252	84113	0	219	84307	3	406	84525	1	190
83451	4	240	83723	2	223	83893	2	146, 252	84114	7	219	84308	0	406	84526	8	190
83452	1	240	83724	9	224	83897	0	256, 395	84115	4	219	84309	7	406	84528	2	190
83453	8	240	83725	6	223	83900	7	236	84116	1	219	84310	3	406	84529	9	190
83454	5	240	83726	3	224	83901	4	236	84117	8	219	84311	0	406	84530	5	190
83455	2	240	83727	0	223	83902	1	236	84118	5	219	84327	1	192	84531	2	93
83456	9	240	83728	7	224	83903	8	236	84119	2	219	84329	5	192	84532	9	93
83457	6	240	83730	0	224	83904	5	236	84124	6	228	84331	8	192	84535	0	337
83466	8	240, 243	83732	4	224	83905	2	236	84125	3	228	84334	9	192	84536	7	337
83467	5	240	83734	8	224, 225	83906	9	236	84126	0	228	84335	6	192	84555	8	209
83468	2	240	83735	5	223	83907	6	236	84128	4	228, 257	84336	3	192	84556	5	209
83469	9	240	83736	2	225	83908	3	236	84130	7	229	84337	0	192	84558	9	210
83479	8	238	83738	6	225	83909	0	236	84131	4	229	84348	6	223	84559	6	210
83480	4	238	83739	3	223	83910	6	237	84132	1	229	84349	3	223	84561	9	210
83481	1	71, 238	83740	9	225	83911	3	237	84133	8	229	84350	9	223	84562	6	210
83482	8	238	83742	3	225	83912	0	234, 237	84134	5	229	84351	6	223	84564	0	209
83483	5	239	83744	7	225	83913	7	234, 237	84135	2	229	84352	3	223	84565	7	209
83484	2	239	83748	5	406	83914	4	237	84136	9	229	84353	0	223	84567	1	200
83486	6	258	83749	2	406	83915	1	237	84140	6	257	84355	4	222	84568	8	200
83487	3	258	83750	8	406	83916	8	86, 237	84141	3	257	84365	3	199	84569	5	201
83488	0	473	83751	5	263	83917	5	86, 237	84142	0	257	84366	0	199	84570	1	201
83489	7	473	83752	2	406	83918	2	237	84158	1	228, 257	84367	7	187, 199	84571	8	201
83490	3	238	83753	9	406	83919	9	237	84161	1	216	84377	6	199	84572	5	201
83491	0	71, 238	83754	6	406	83920	5	34, 237, 248, 533	84165	9	216	84378	3	199	84573	2	201
83492	7	238	83755	3	406	83921	2	237, 533	84168	0	216	84379	0	199	84574	9	201
83497	2	242	83756	0	406	83922	9	237, 533	84170	3	216	84380	6	199	84575	6	200
83498	9	242	83757	7	406	83923	6	237	84171	0	216	84381	3	199	84576	3	200
83499	6	242	83758	4	406	83924	3	237	84172	7	216	84387	5	232	84577	0	201
83500	9	240	83759	1	406	83925	0	237	84174	1	219	84400	1	194	84578	7	201
83513	9	256	83760	7	407	83926	7	237	84177	2	197	84401	8	194	84579	4	201
83514	6	240	83761	4	407	83927	8	222	84178	9	197	84402	5	194	84580	0	201
83538	2	463	83762	1	407	83929	8	222	84179	6	197	84403	2	194	84581	7	201
83560	3	239	83763	8	407	83932	8	224	84180	2	215	84404	9	194	84582	4	201
83561	0	239	83764	5	407	83933	5	224	84181	9	215	84408	7	241	84583	1	209
83562	7	239	83765	2	407	83934	2	224	84182	6	215	84409	4	241	84584	8	209
83563	4	239	83766	9	407	83935	9	224	84183	3	215	84414	8	241, 243	84586	2	209
83568	9	240, 243	83768	3	407	83940	3	225	84184	0	215	84415	5	241, 243	84587	9	209
83569	6	240, 243	83769	0	407	83941	0	225	84185	7	25, 215	84416	2	241	84589	3	209
83570	2	240	83770	6	407	83946	5	225	84186	4	25, 215	84417	9	241	84590	9	209
83571	9	240	83772	0	407	83947	2	225	84187	1	71, 215	84418	6	241	84592	3	210
83572	6	240	83773	7	407	83948	9	225	84188	8	25, 215	84420	9	241, 243	84593	0	210
83573	3	240	83777	5	248	83949	6	225	84189	5	25, 215	84421	6	241	84595	4	211
83574	0	240	83780	5	248	83955	7	212	84195	6	25, 215	84422	3	241	84596	1	211
83575	7	240	83781	2	248, 274, 370	83956	4	212	84196	3	25, 215	84423	0	241	84598	5	211
83587	0	233	83782	9	248	83957	1	212	84197	0	71, 215	84424	7	240	84599	2	211
83588	7	238	83783	6	248	83958	8	212	84198	7	25, 215	84425	4	240	84601	2	206
83589	4	238	83784	3	248	83960	1	235	84199	4	25, 215	84426	1	240	84602	9	206
83592	4	238	83785	0	232	83961	8	235	84200	7	233	84427	8	240	84603	6	206
83597	9	238	83786	7	232	83962	5	235	84202	1	233	84434	6	197	84604	3	206
83600	6	213, 241, 533	83787	4	232	83965	6	235	84205	2	198	84435	3	197	84605	0	207
83601	3	210, 123, 241, 533	83788	1	232	83966	3	235	84206	9	198	84440	7	238	84606	7	207
83602	0	241, 533	83789	8	232	83967	0	235	84207	6	198	84441	4	238	84607	4	207
83603	7	242	83790	4	232	83971	7	212	84208	3	198	84444	5	261	84608	1	207
83604	4	242	83798	0	248	83980	9	212	84209	0	198	84445	2	261	84609	8	207
83605	1	249, 533	83799	7	232	83981	6	212	84215	1	250	84446	9	261	84610	4	207
83606	8	249, 533	83800	0	231	83992	2	213	84216	8	250	84448	3	261	84611	1	207
83607	5	249, 533	83801	7	256, 395	83994	6	213	84217	5	229, 262	84449	0	261	84612	8	207
83610	5	473	83803	1	256, 395	83999	1	338	84220	5	250	84450	6	262	84613	5	207
83611	2	473	83808	6	231	84017	1	262	84221	2	250	84452	0	262	84614	2	207
83612	9	473	83810	9	231	84018	8	262	84222	9	250	84454	4	262	84615	9	207
83613	6	473	83812	3	231	84020	1	255	84229	8	227	84456	8	262	84616	6	207
83614	3	473	83814	7	231	84021	8	255	84230	4	227	84458	2	262	84620	3	144, 256
83615	0	94	83826	0	231	84022	5	226	84231	1	227	84460	5	262</			

84673	9	178	84831	3	194	85003	3	245	88080	1	502, 510	93034	6	442	93310	1	430
84674	6	179	84835	1	187	85005	7	245	88081	8	502, 510	93101	5	454	93311	8	430
84675	3	179	84836	8	187	85020	0	184	88090	0	510	93102	2	449	93312	5	443
84676	0	179	84837	5	187	85021	7	184	88099	3	502	93105	3	60, 425	93313	2	443
84677	7	179	84840	5	259	85022	4	184	88200	3	396	93110	7	455	93314	9	451
84678	4	179	84841	2	259	85023	1	184	88201	0	396	93111	4	455	93315	6	451
84680	7	180	84842	9	259	85024	8	185	88202	7	396	93112	1	441	93318	7	445
84681	4	180	84843	6	259	85025	5	184	88204	1	396	93114	5	455	93321	7	152, 411
84682	1	180	84844	3	259	85026	2	185	88205	8	396	93115	2	455	93322	4	430
84683	8	180	84845	0	259	85027	9	184	88206	5	396	93116	9	441	93323	1	430
84684	5	181	84860	3	74	85028	6	184	88207	2	396	93120	6	441	93324	8	440
84685	2	181	84861	0	74	85029	3	185	88208	9	396	93121	3	441	93325	5	438
84686	9	181	84862	7	74	85030	9	185	88209	6	396	93122	0	457	93326	2	437
84687	6	181	84863	4	74	85031	6	185	88210	2	396	93124	4	457	93327	9	434
84688	3	181	84875	7	216	85032	3	185	88211	9	396	93125	1	457	93328	6	434
84689	0	181	84876	4	216	85033	0	146, 185, 329	88212	6	396	93129	9	442	93329	3	434
84690	6	181	84880	1	188	85034	7	146, 185, 329	88220	1	270	93134	3	442	93330	9	416, 429
84720	0	197	84881	8	188	85035	4	146, 185, 329	88221	8	270	93138	1	443	93331	6	431
84721	7	197	84882	5	188	85040	8	253	88222	5	270	93139	8	438	93332	3	431
84722	4	197	84883	2	188	85041	5	253	88223	2	270	93140	4	438	93333	0	431
84723	1	197	84884	9	188	85042	2	253	88224	9	270	93141	1	454	93334	7	433
84724	8	197	84885	6	188	85043	9	253	88225	6	270	93144	2	454	93335	4	433
84725	5	177	84886	3	188	85046	0	146, 213, 329	88226	3	270	93145	9	454	93336	1	434
84726	2	177	84890	0	196	85047	7	146, 213, 329	88227	0	270	93146	6	454	93337	8	434
84727	9	177	84891	7	196	85048	4	146, 213, 329	88228	7	270	93147	3	454	93338	5	434
84728	6	218	84892	4	196	85051	4	147, 149, 252, 330, 528	88229	4	270	93148	0	454	93342	2	431
84729	3	218	84900	6	220	85052	1	147, 149, 252, 330, 528	88246	1	400	93151	0	518	93343	9	431
84730	9	218	84901	3	220	85060	6	165	88256	0	521	93152	7	442	93344	6	431
84731	6	218	84902	0	220	85061	3	165	88271	3	518	93153	4	442	93345	3	430
84732	3	218	84903	7	220	85062	0	165	88285	0	404	93154	1	516	93346	0	429
84733	0	218	84904	4	220	85063	7	164	88287	4	514	93155	8	516	93347	7	443
84740	8	186	84905	1	221	85064	4	164	88288	1	514	93156	5	516	93348	4	443
84741	5	186	84906	8	221	85065	1	164	88598	1	493	93157	2	516	93349	1	443
84742	2	186	84907	5	221	85066	8	164	88608	7	479	93160	2	455	93350	7	438
84743	9	186	84908	2	221	85067	5	164	88609	4	493	93161	9	453	93351	4	439
84744	6	186	84909	9	221	85068	2	164	88617	9	504	93163	3	516	93352	1	439
84745	3	186	84910	5	221	85069	9	165	88618	6	504	93164	0	440	93353	8	439
84746	0	186	84911	2	221	85070	5	165	88627	8	493	93165	7	440	93354	5	439
84747	7	186	84912	9	221	85071	2	165	88628	5	493	93166	4	451	93355	2	440
84748	4	186	84913	6	221	85072	9	165	88636	0	493	93167	1	451	93356	9	441
84749	1	186	84914	3	221	85080	4	160	88637	7	479	93168	8	451	93357	6	441
84750	7	260	84915	0	221	85081	1	160	88639	1	504	93169	5	451	93358	3	444
84751	4	260	84921	1	204	85082	8	161	88640	7	478	93170	1	453	93360	6	444
84752	1	260	84922	8	204	85083	5	161	88642	1	478	93171	8	452	93361	3	444
84753	8	260	84923	5	204	85084	2	161	88643	8	491	93173	2	451	93362	0	444
84754	5	260	84924	2	204	85088	0	254	88644	5	491	93174	9	452	93364	4	432
84760	6	260	84925	9	204	85091	0	254	88645	2	491	93175	6	448	93365	1	432
84761	3	260	84926	6	205	85098	0	254	88688	9	506	93179	4	437	93366	8	437
84762	0	260	84927	3	205	85100	9	162	88717	6	505	93180	0	444	93367	5	429
84763	7	260	84928	0	205	85101	6	162	88810	4	496	93181	7	444	93368	2	442
84764	4	260	84929	7	205	85103	0	162	88811	1	496	93182	4	444	93369	9	442
84775	0	261	84930	3	208	85104	7	162	88823	4	496	93188	6	444	93370	5	431
84776	7	261	84931	0	208	85105	4	162	88826	5	496	93189	3	446, 513	93371	2	432
84777	4	261	84932	7	208	85107	8	162	88827	2	496	93190	9	449	93372	9	432
84778	1	261	84933	4	208	85108	5	162	88829	6	497	93191	6	448	93373	6	432
84779	8	261	84934	1	208	85109	2	162	88834	0	497	93192	3	448	93374	3	432
84780	4	261	84935	8	208	85111	5	162	88836	4	497	93200	5	447	93375	0	433
84781	1	261	84936	5	208	85112	2	149, 162, 528	88839	5	498	93201	2	438	93380	4	450
84782	8	261	84937	2	208	85113	9	162	88840	1	498	93211	1	437	93381	1	450
84783	5	261	84938	9	208	85115	3	162	88843	2	445, 498	93212	8	437	93382	8	450
84785	9	232	84939	6	209	85116	0	162	88846	3	445, 497	93214	2	446, 513	93383	5	450
84786	6	232	84940	2	209	85117	7	162	88850	0	497	93220	3	447	93384	2	450
84787	3	232	84941	9	205	85118	4	162	88853	1	498	93225	8	515	93385	9	450
84800	9	183	84942	6	205	85119	1	162	88855	5	514	93226	5	515	93386	6	450
84801	6	183	84943	3	205	85120	7	163	88900	2	514	93230	2	61, 447	93390	3	450
84802	3	183	84944	0	205	85121	4	163	88901	9	514	93250	0	517	93391	0	450
84803	0	183	84945	7	205	85123	8	163	88902	6	514	93251	7	517	93392	7	450
84804	7	183	84946	4	205	85124	5	163	88903	3	515	93252	4	517	93393	4	450
84805	4	183	84947	1	210	85125	2	163	88911	8	514	93253	1	517	93394	1	450
84806	1	183	84948	8	210	85127	6	163	88912	5	514	93254	8	517	93395	8	450
84807	8	183	84949	5	210	85128	3	163	88920	0	499	93255	5	517	93398	9	418, 433
84808	5	183	84950	1	247	85129	0	163	88921	7	499	93256	2	517	93399	6	418, 433
84809	2	182	84951	8	247	85131	3	163	88922	4	499	93257	9	517	93400	9	418, 433
84810	8	183	84952	5	246	85132	0	163	88923	1	499	93258	6	517	98002	0	99
84811	5	183	84953	2	246	85133	7	163	88928	6	499	93259	3	516	98003	7	99
84812	2	183	84954	9	246	85135	1	163	88929	3	501	93260	9	516	98040	2	99
84813	9	183	84955	6	247	85140	5	251	88930	9	501	93261	6	516	98041	9	99
84814	6	183	84956	3	247	85141	2	251	88932	3	499	93270	8	517	98120	1	96
84815	3	182	84957	0	247	85145	0	195	88933	0	499	93271	5	517	98129	4	97
84816	0	182	84958	7	247	85146	7	195	88935	4	500	93272	2	517	98130	0	97
84817	7	182	84959	4	247	85150	4	229	88937	8	500	93273	9	517	98131	7	97
84818	4	182	84962	4	532	85151	1	229	88938	5	500	93274	6				



ACCORD GROUP

Accord Group LLC

+38 (044) 33 777 88
+38 (098) 33 777 88

83, Chervonotkatska str.
Kyiv, Ukraine

<https://a-g.ua>
info@a-g.ua

<https://a-g.ua>